

# User Manual

## DA7280 Performance Board

### UM-AU-011



#### Abstract

*This document is the User Manual for the DA7280 Performance Board, 359-02-B.*

---

---

 DA7280 Performance Board
 

---

## Contents

<b>Abstract</b> .....	<b>1</b>
<b>Contents</b> .....	<b>2</b>
<b>Figures</b> .....	<b>3</b>
<b>Tables</b> .....	<b>4</b>
<b>1 Terms and Definitions</b> .....	<b>4</b>
<b>2 References</b> .....	<b>4</b>
<b>3 Introduction</b> .....	<b>4</b>
<b>4 Quick Start Setup</b> .....	<b>5</b>
<b>5 Hardware and Software Prerequisites</b> .....	<b>6</b>
5.1 SmartCanvas GUI Setup .....	6
<b>6 Hardware Overview</b> .....	<b>9</b>
6.1 Power .....	9
6.2 I <sup>2</sup> C Communications .....	9
6.3 DA7280 .....	9
6.4 Accelerometer .....	10
6.5 Metal Mass Connection .....	10
6.6 LRA Connection .....	10
<b>7 Software Control</b> .....	<b>11</b>
7.1 LRA Setup Scripts .....	12
7.1.1 Load LRA Setup Scripts .....	12
7.1.2 Save All Registers .....	13
7.1.3 Setup Scripts for Supplied LRA .....	15
7.1.3.1 JAHWA_1040_FREQ_TRACK_ON .....	16
7.1.3.2 JAHWA_1040_FREQ_TRACK_ON_RS_ON .....	18
7.1.3.3 JAHWA_1040_FREQ_TRACK_OFF_SINE .....	20
7.2 Operating Modes .....	22
7.2.1 Direct Register Override Mode (DRO) .....	23
7.2.2 Register Triggered Waveform Memory (RTWM).....	24
7.2.3 Pulse Width Modulation Mode (PWM) .....	25
7.2.4 Edge Triggered Waveform Memory (ETWM).....	25
7.3 Waveform Memory Editor .....	26
7.3.1 Setting Operation Mode .....	27
7.3.2 Snippets Tab .....	27
7.3.3 Sequences Tab .....	28
7.3.3.1 Changing Snippet Parameter Values .....	29
7.4 Wav to Haptics Converter .....	30
7.5 IRQ .....	32
7.6 Cap Sense Setup.....	34
7.7 GPI Triggering from GUI .....	35
<b>8 Monitoring Drive Signals and Measuring Acceleration</b> .....	<b>36</b>
<b>9 Measuring current</b> .....	<b>37</b>

Revision History .....	38
------------------------	----

## Figures

Figure 1: License Agreement.....	6
Figure 2: Create a Desktop Item .....	6
Figure 3: Install the GUI .....	7
Figure 4: Finish Setup.....	7
Figure 5: Installing Driver Windows Notification .....	7
Figure 6: Installation Complete .....	8
Figure 7: Desktop Icon.....	8
Figure 8: Performance Board Functionality.....	9
Figure 9: PCB with Metal Mass.....	10
Figure 10: Main GUI Window .....	11
Figure 10: Main GUI Window .....	11
Figure 11: File I/O .....	12
Figure 12: Load Register Dump.....	13
Figure 13: File I/O .....	13
Figure 14: Save All Registers Dialog Box .....	14
Figure 15: LRA Characteristics Graph .....	15
Figure 16: JAHWA_1040_FREQ_TRACK_ON Parameters.....	16
Figure 17: JAHWA_1040_FREQ_TRACK_ON Sequences .....	17
Figure 18: JAHWA_1040_FREQ_TRACK_ON_RS_ON Parameters.....	18
Figure 19: JAHWA_1040_FREQ_TRACK_ON_RS_ON Sequences .....	19
Figure 20: JAHWA_1040_FREQ_TRACK_OFF_SINE Parameters .....	20
Figure 21: JAHWA_1040_FREQ_TRACK_OFF_SINE Sequences .....	21
Figure 22: Drive Type .....	22
Figure 23: Operation Mode .....	22
Figure 24: GUI in DRO Mode.....	23
Figure 25: GUI in RTWM Mode.....	24
Figure 26: GPI Registers .....	25
Figure 27: Enabling the Waveform Memory Editor.....	26
Figure 28: Register Syncing from DA7280 Memory .....	26
Figure 29: Set RTWM Mode in Operation Mode .....	27
Figure 30: Waveform Memory Editor Snippets Tab .....	27
Figure 31: Waveform Memory Editor Sequences Tab .....	28
Figure 32: Two Snippet Sequence Example .....	29
Figure 33: Snippets for the Two Snippet Sequence Example .....	29
Figure 34: Launching Wav to Haptics Converter.....	30
Figure 35: Wav To Haptics Converter Plugin .....	30
Figure 36: Included Sound Effect Files .....	31
Figure 37: Detailed Descriptions of Controls.....	31
Figure 38: IRQ Tab .....	32
Figure 39: Clear IRQ Events and Faults .....	32
Figure 40: Embedded Mode .....	33
Figure 41: SAM3U Configuration .....	34
Figure 42: ETWM Mode.....	34
Figure 43: GPI_0_CTL Settings.....	34
Figure 44: Controlling GPIs from GUI .....	35
Figure 45: Monitoring Signals .....	36
Figure 46: Measured Output Signals and Acceleration Profile .....	36
Figure 47: Measuring current board modifications .....	37

---

**DA7280 Performance Board**

## Tables

Table 1: JAHWA_1040_FREQ_TRACK_ON script features: .....	16
Table 2: JAHWA_1040_FREQ_TRACK_ON_RS_ON script features:.....	18
Table 3: JAHWA_1040_FREQ_TRACK_OFF_SINE script features:.....	20

## 1 Terms and Definitions

359-02-B	Performance Board PCB containing DUT, LRA and accelerometer circuitry
DA7280	Dialog Semiconductor's Haptic Driver I.C
DRO	Direct Register Override
DUT	Device Under Test
ERM	Eccentric Rotating Mass
ETWM	Edge Triggered Waveform Memory
GUI	Graphical User Interface, see SmartCanvas definition below.
I <sup>2</sup> C	Inter-Integrated Circuit communication standard
LRA	Linear Resonant Actuator
PCB	Printed Circuit Board
PWL	Piecewise-Linear time and amplitude pairs for defining snippets in waveform memory
PWM	Pulse Width Modulation
RTWM	Register Triggered Waveform Memory
SmartCanvas	Dialog Semiconductor's (GUI) software tool for controlling DA7280 over USB
SAM3U	Dialog Semiconductor's USB Module for I <sup>2</sup> C communication over USB
USB	Universal Serial Bus
WLCSP	Wafer Level Chip Scale Package

## 2 References

- [1] DA7280, Datasheet, Dialog Semiconductor
- [2] 359-02-B\_SCH.pdf, Performance Board Schematic

## 3 Introduction

This is the DA7280 Performance Board user manual. It describes how to use the 359-02-B to experience the haptic capabilities of DA7280 with the supplied LRA. DA7280 is configured and controlled by Dialog Semiconductor's *SmartCanvas*<sup>™</sup> graphical user interface (GUI) over USB. DA7280 is capable of driving either LRA or ERM type motors, but this User Manual will focus on usage with the supplied LRA.

---

## DA7280 Performance Board

### 4 Quick Start Setup

1. Install the GUI.
2. Connect the USB cable from the computer to the Performance Board, if this is the first-time connecting Windows will automatically install Dialog's USB Drivers.
3. Check that the LRA is connected to header J4.
4. Isolate the Performance Board from hard surfaces as this can dampen the haptic feedback. For example, the foam inserts shipped with the Performance Board is ideal.
5. Open the **GUI**.
6. In the popup window press **Download Default Setup Scripts**, this enables DA7280 to work with the cap sense buttons on the PCB.
7. Pressing B0, B1 or B2 cap sense buttons on the PCB will trigger haptic sequences.

## DA7280 Performance Board

### 5 Hardware and Software Prerequisites

The GUI **must** be installed before plugging in the DA7280 Performance board hardware on a Windows® 7 or Windows® 10 operating system. The DA7280 GUI installation file is included with the Performance Board kit. Run the .exe file to start the installation.

The latest version of the GUI can be found at <https://support.dialog-semiconductor.com/> under the **PMIC & Audio & Haptics** section.

#### 5.1 SmartCanvas GUI Setup

Follow the steps in the Setup Wizard:

1. Click the - **I accept the agreement** option button.

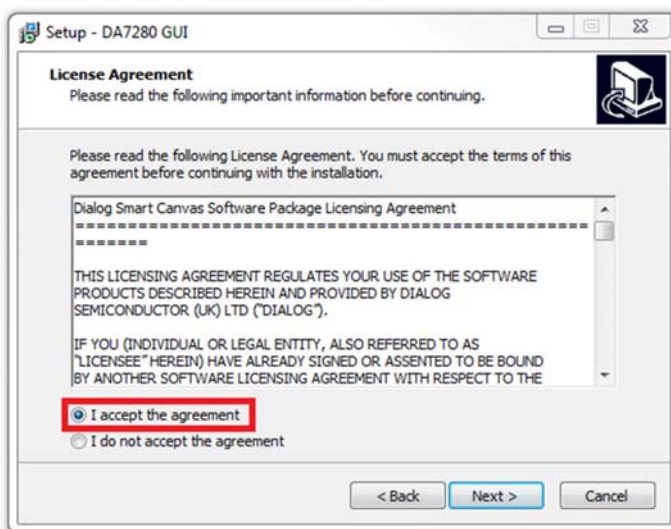

Figure 1: License Agreement

2. Click **Next**.

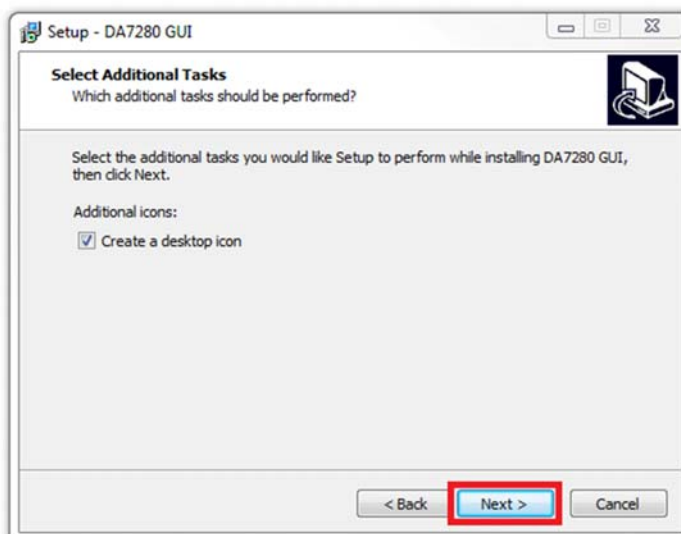

Figure 2: Create a Desktop Item

## DA7280 Performance Board

3. Click **Install**.

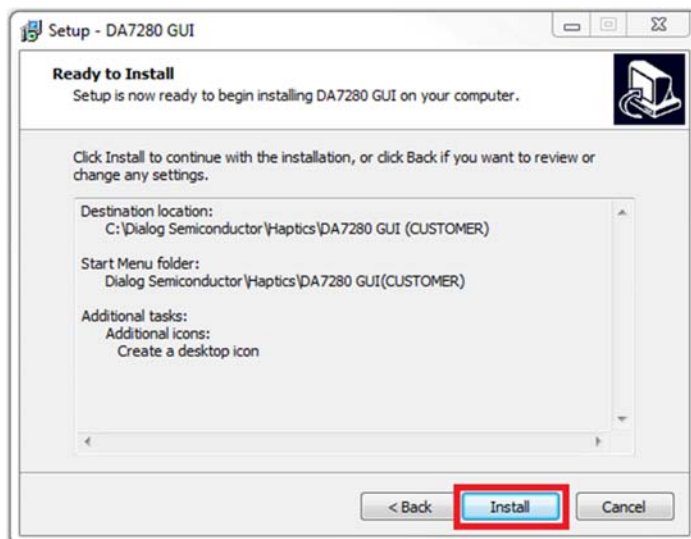

Figure 3: Install the GUI

4. Clear the **Launch DA7280 GUI** check box and click **Finish**.

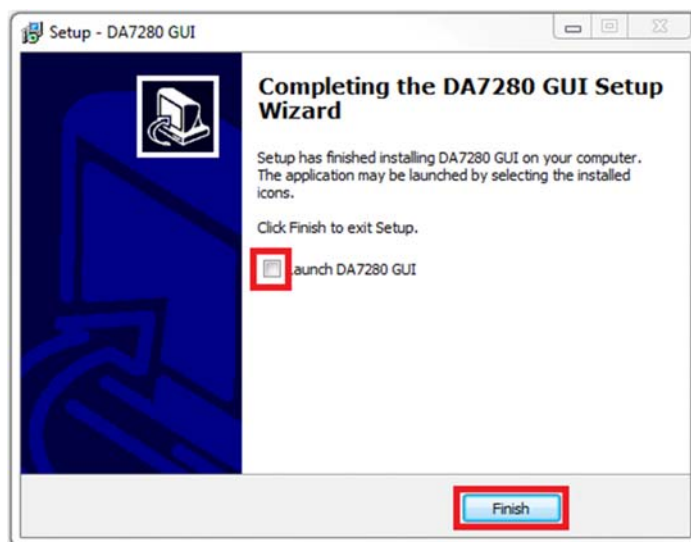

Figure 4: Finish Setup

5. Connect the universal serial bus (USB) cable from the Performance Board printed circuit board (PCB) to the computer.

Windows will now install the required drivers.

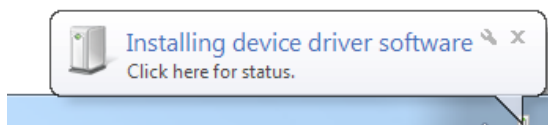
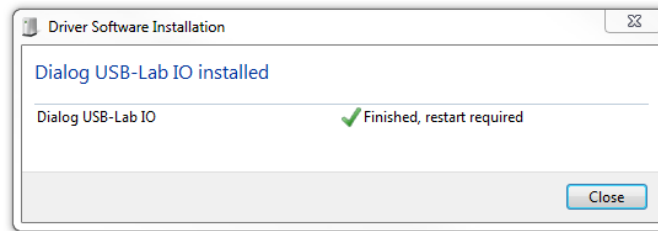

Figure 5: Installing Driver Windows Notification

---

**DA7280 Performance Board**

**Figure 6: Installation Complete**

6. Click the desktop icon to run the **DA7280 GUI**



**Figure 7: Desktop Icon**



## DA7280 Performance Board

### 6 Hardware Overview

The board is powered and controlled from the onboard USB circuitry. The device-under-test (DUT) side can be completely isolated from the USB controller side both in terms of power and I<sup>2</sup>C, or general purpose interface (GPI) signals, by de-soldering the solder bumps connections.

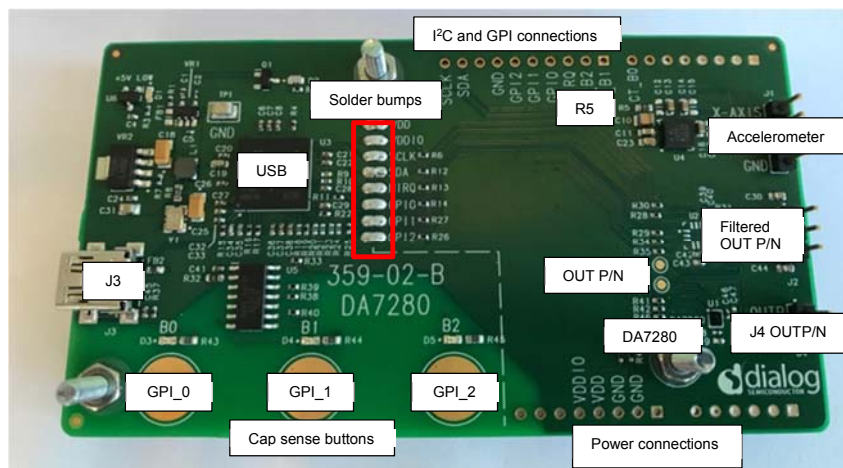

Figure 8: Performance Board Functionality

#### 6.1 Power

The board and DA7280 are powered from the 5 V USB power supply (J3), additional external power supplies are not required. VDDIO is powered from an onboard, regulated 1.8 V supply. DA7280 is capable of driving 250 mA into the linear resonant actuator (LRA) load, so the USB power is adequate for most applications. When driving with Double Output Current Range enabled and driving 500 mA, supply VDD from an external supply.

To externally power the board and take accurate current measurements, de-solder the VDD and VDDIO solder bumps and connect the supplies via the labeled through-hole connections, see **Power connections** in [Figure 8](#). When taking current measurements on the board, remove resistor R5 this powers down the accelerometer.

#### 6.2 I<sup>2</sup>C Communications

The GUI communicates to the DA7280 through Dialog's USB to I<sup>2</sup>C interface. DA7280 slave address is 0x4A, when adding the R/W bit the I<sup>2</sup>C read = 0x94 and the I<sup>2</sup>C write = 0x95.

To use external I<sup>2</sup>C communication, de-solder the SDA and SCLK solder bumps and connect the external I<sup>2</sup>C wires into the through-hole connections, labeled SCLK and SDA, see **I<sup>2</sup>C and GPI connections** in [Figure 8](#).

If external I<sup>2</sup>C signaling is used, the VDDIO voltage level should be set to the external I<sup>2</sup>C signal voltage level.

#### 6.3 DA7280

DA7280 is located in either position U1 (QFN) or U2 (WLCSP), see [Figure 8](#), depending on the supplied package variant on the board. The silicon in both package variants is identical.

After power-on reset, download the setup script see [7.1.1](#) for the supplied LRA. This ensures the correct DC parameters are driving the LRA according to the LRA's datasheet. If a different LRA is used, the settings should be adjusted according to that specific LRA's electrical parameters.

To drive the LRA DA7280 outputs PWM differential signals to two locations on the board:

- Solder pads labeled OUTP and OUTN
- J4 header pins labeled OUTP and OUTN.

## DA7280 Performance Board

Connect the LRA to only one of these positions.

Filtered OUT\_P and OUT\_N signals from DA7280 are accessed from the OUTP\_F and OUTN\_F pins (J2). Connect J2 to an oscilloscope for signal monitoring and tuning purposes, see [Section 8](#).

### 6.4 Accelerometer

A high-precision accelerometer (U4) is fitted to capture the acceleration profile of the LRA see [Figure 8](#). This is used to evaluate and tune the LRA's performance. See [Section 8](#).

### 6.5 Metal Mass Connection

To create a reference 100-gram mass, tightly screw the metal mass to the PCB, see [Figure 9](#). This is useful for evaluating LRA performance with respect to the amount of acceleration (g) the LRA produces attached to this reference weight.

If fly wiring power or control signals, ensure that these connections do not electrically short to the metal mass. A thin piece of card is placed between the mass and the PCB; also electrical insulating tape could be used.

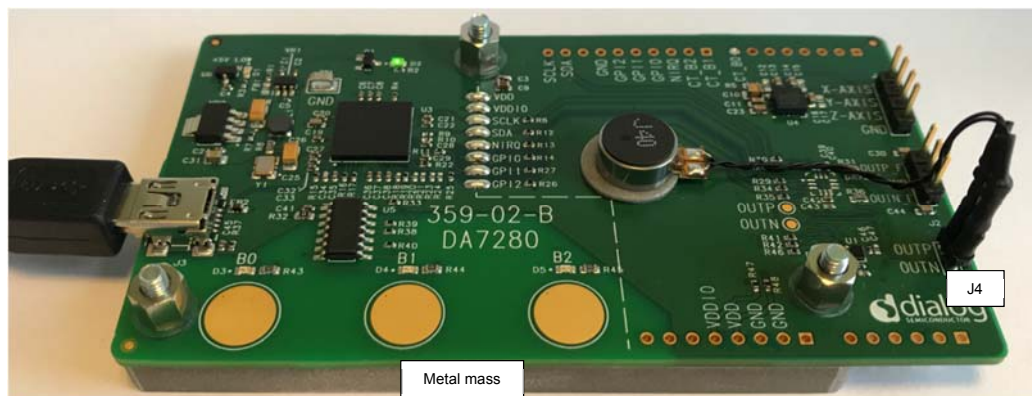

**Figure 9: PCB with Metal Mass**

### 6.6 LRA Connection

Fix the LRA to the top of the PCB, glue or double sided sticky pads can be used. Ensure the LRA is firmly connected and has no movement when been driven to reduce damping. If using glue to connect the LRA to the PCB, ensure the glue does not enter the LRA housing through any relief openings on the LRA.

Connect the LRA terminals to the OUT\_P and OUT\_N header (J4), see [Figure 9](#). The orientation of LRA terminals to the header pins is not important.

DA7280 Performance Board

## 7 Software Control

After starting the GUI this popup setup window is presented to the user, pressing **Download Default Startup Scripts** button will set DA7280 in Edge Triggered Mode so the cap sense buttons trigger haptic sequences. Close Window will close the window while not setting up DA7280 in any mode.

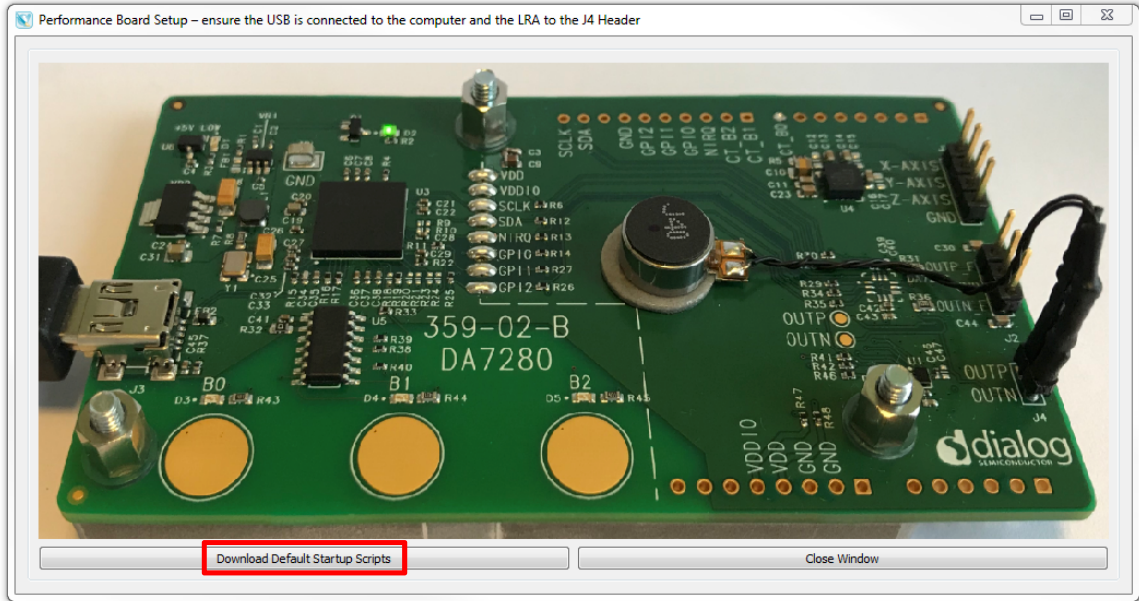

Figure 10: Performance Board Setup

The main window of the GUI looks like this, check the status of the following connections:

- a. **Bus and USB communication LEDs are green.**
- b. **Enable/Disable Polling button is green and states Enabled.**

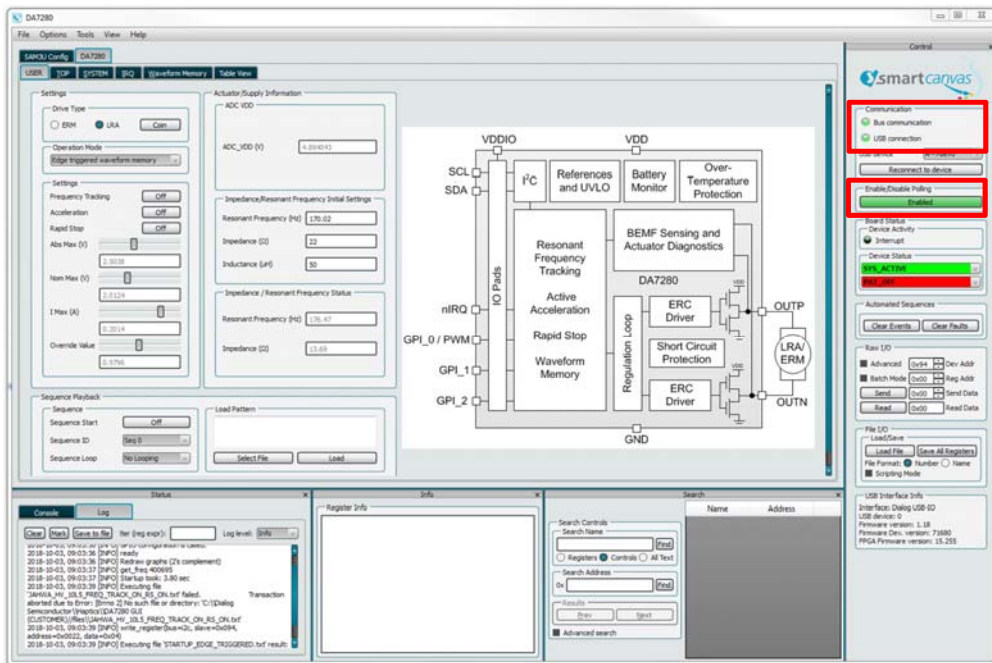

Figure 11: Main GUI Window

## DA7280 Performance Board

### 7.1 LRA Setup Scripts

There are three setup scripts bundled with the GUI for the supplied Jahwa 1040 LRA. These scripts include specific LRA configuration parameters, DA7280 feature configuration parameters, and waveform memory data; these are described in section 7.1.3.

#### 7.1.1 Load LRA Setup Scripts

To download the scripts:

1. In the **File I/O window**, click on the **Load File** button, see [Figure 12](#).

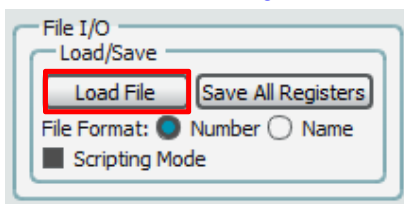

Figure 12: File I/O

2. Select the required .txt download script for the Jahwa LRA from the **Load Register Dump** popup window, see [Figure 13](#). For the supplied LRA only download scripts with 'JAHWA\_1040' prefix.

## DA7280 Performance Board

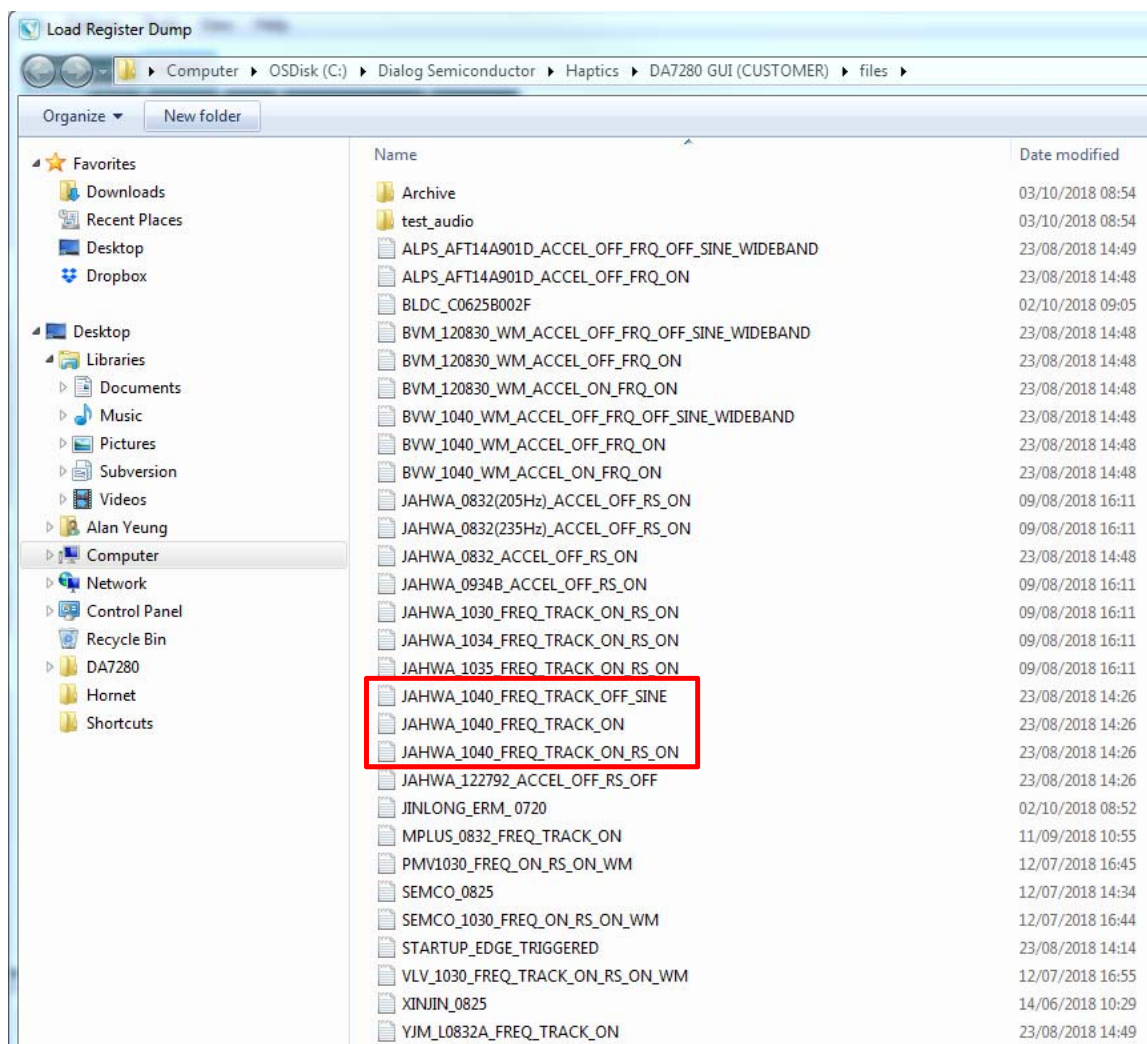

Figure 13: Load Register Dump

### 7.1.2 Save All Registers

To save the current status of DA7280 registers:

1. In the **File I/O window**, click on **Save All Registers**, see [Figure 14](#).

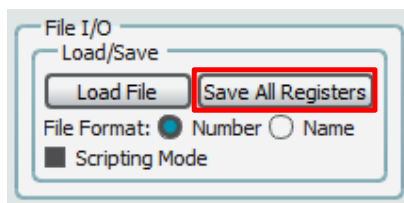

Figure 14: File I/O

2. In the **Save All Registers** dialog box, in the **File name** field, type in the file name.
3. In the **Save All Registers** dialog box, in the **Save as type** field, select the file format using the drop-down menu.

---

**DA7280 Performance Board****Note:**

- a. Normally **.txt** is used however **.csv** format also saves the IRQ status registers. The **.csv** format is useful for debugging, see [Figure 15](#).
- b. The **File Format** options **Number** or **Name** will save the registers either by register number or by register name.

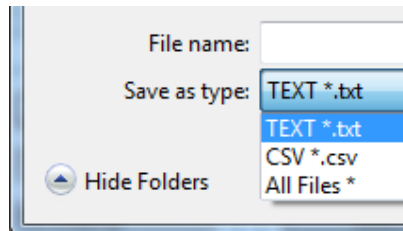
**Figure 15: Save All Registers Dialog Box**

## DA7280 Performance Board

### 7.1.3 Setup Scripts for Supplied LRA

The JAHWA\_1040 LRA setup scripts include specific [Jahwa](#) configuration parameters, DA7280 feature configuration parameters, and waveform memory data. This LRA is also known as the 1040 model. This LRA has fast rise time and the Acceleration feature of DA7280 does not need to be enabled.

This LRA has the following specifications.

- Rated Voltage = 2.5 V(*rms*)
- Frequency = 170 Hz  $\pm$  10 Hz
- Vibration = 2.0 G
- Rated current = 170 mA
- Noise = 35 dB (max)
- Rise time (50 %) = max 10 ms
- Fall time (50 %) = max 50 ms
- *Measured impedance* = 13  $\Omega$
- *Measured inductance* = 353  $\mu$ H

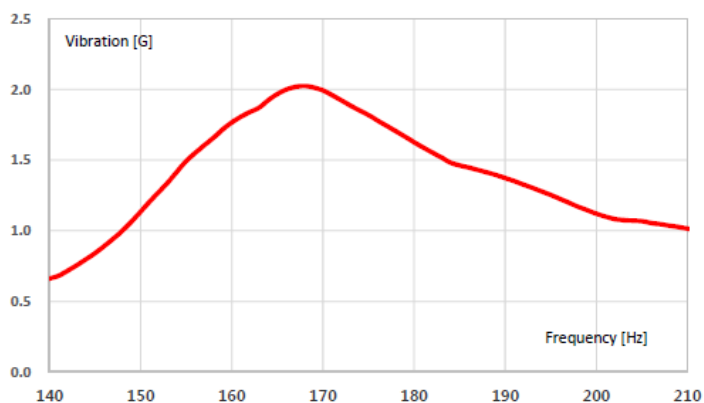

5-2 . Current vs Voltage

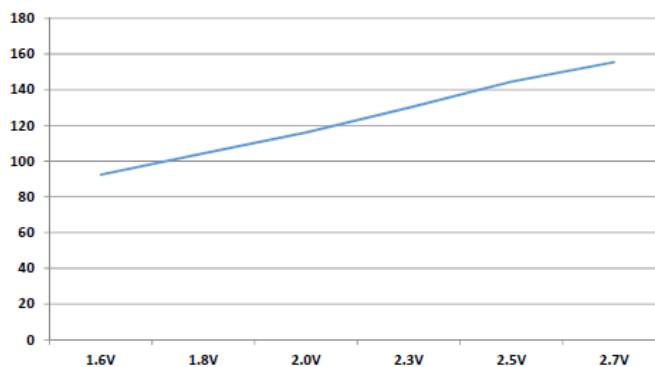

Figure 16: LRA Characteristics Graph

DA7280 Performance Board

The following 3 setup scripts are provided with the GUI for the supplied LRA. To Load these scripts see section 7.1.1

7.1.3.1 JAHWA\_1040\_FREQ\_TRACK\_ON

The JAHWA\_1040\_FREQ\_TRACK\_ON.txt script sets up the DA7280 to enable the features shown in Table 1.

Table 1: JAHWA\_1040\_FREQ\_TRACK\_ON script features:

Feature	Status
Frequency tracking	ON
Acceleration	OFF
Rapid stop	OFF

After the scripts have loaded, the GUI shows the parameter settings as applied by the setup script.

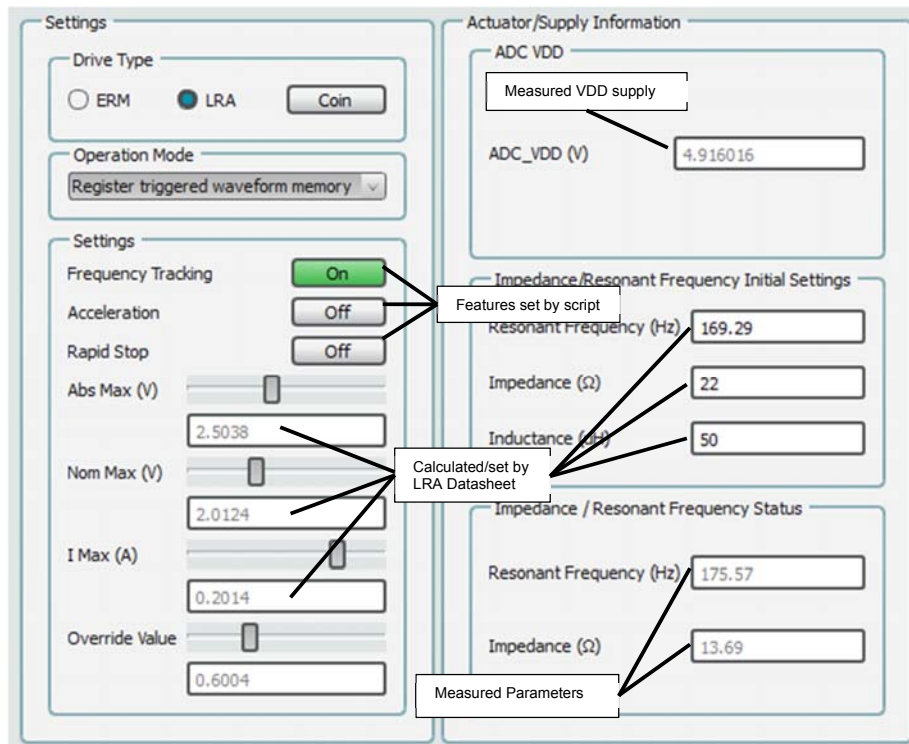

Figure 17: JAHWA\_1040\_FREQ\_TRACK\_ON Parameters

The measured resonant frequency and impedance of the supplied LRA are shown in the GUI, see Figure 17.

The Abs Max and Nom Max voltages for the LRA are calculated and set in the GUI by the script as follows:

- Abs Max = (I<sub>MAX</sub> \* 1.1) \* measured impedance = 2.51 V
- Nom Max = (measured impedance \* I<sub>MAX</sub>) \* 0.707 = 2 V

Notes:

1. These are conservative settings following LRA manufacturer's recommendations.
2. The Impedance and Inductance values after downloading setup scripts are not updated, but the underlying registers in DA7280 are set correct for the LRA.



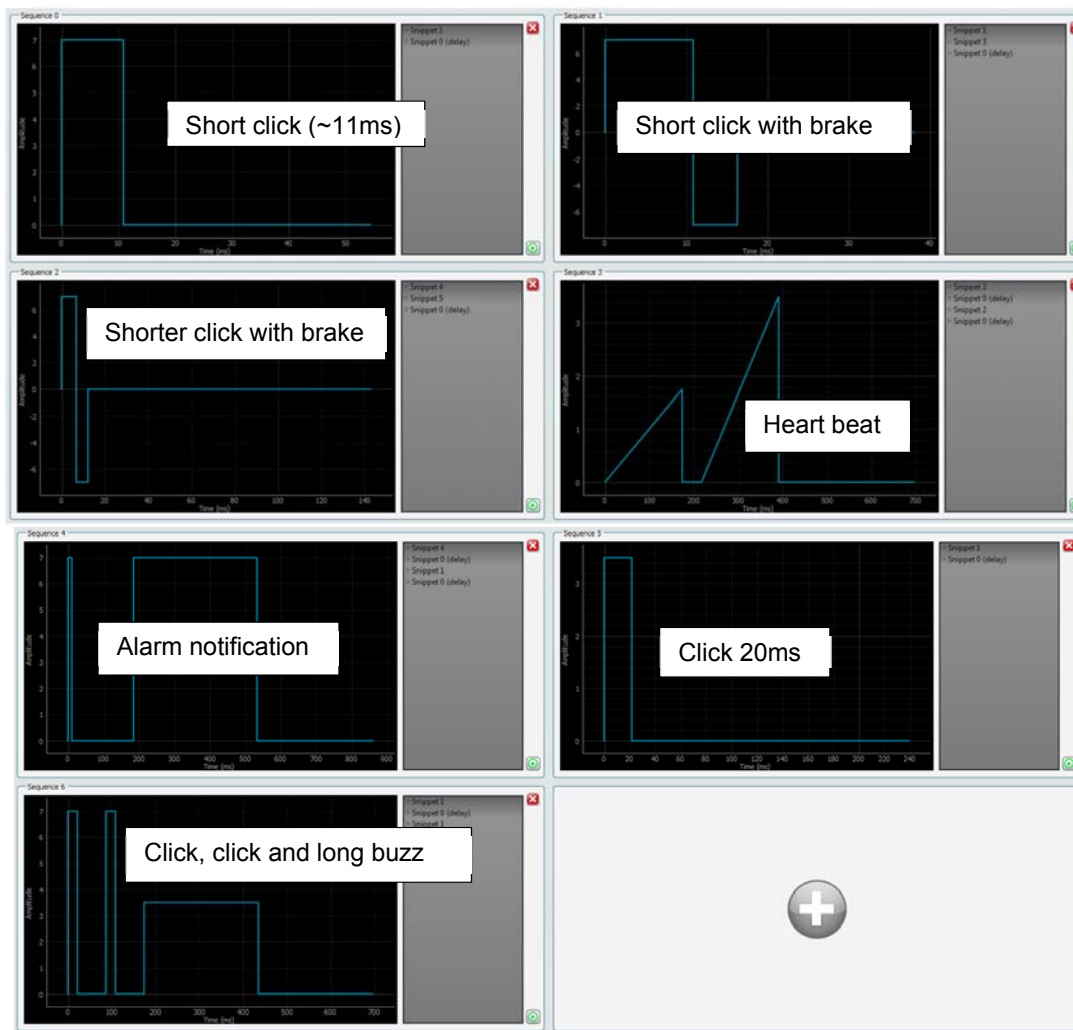

Figure 18: JAHWA\_1040\_FREQ\_TRACK\_ON Sequences

The haptic sequences loaded from the setup scripts are displayed in the GUI, see Section 7.3. For the JAHWA\_1040\_FREQ\_TRACK\_ON script, the sequences are shown in Figure 18.

DA7280 Performance Board

7.1.3.2 JAHWA\_1040\_FREQ\_TRACK\_ON\_RS\_ON

The JAHWA\_1040\_FREQ\_TRACK\_ON\_RS\_ON.txt script sets up the DA7280 to enable the features shown in Table 2.

Table 2: JAHWA\_1040\_FREQ\_TRACK\_ON\_RS\_ON script features:

Feature	Status
Frequency tracking	ON
Acceleration	OFF
Rapid stop	ON

After the scripts have loaded, the GUI shows the parameter settings as applied by the setup script. See Figure 19

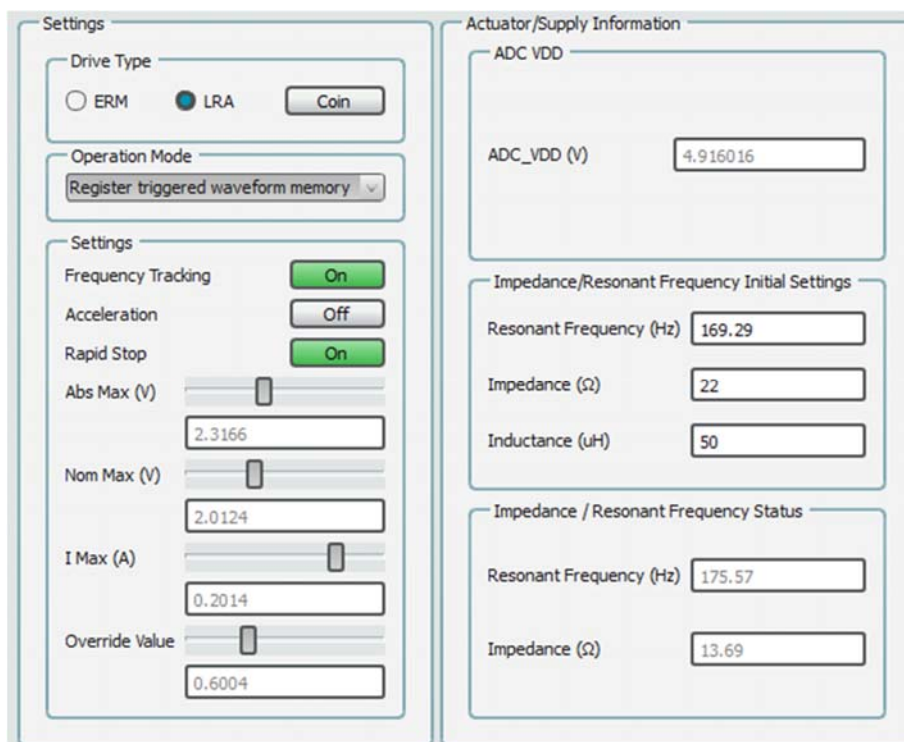

Figure 19: JAHWA\_1040\_FREQ\_TRACK\_ON\_RS\_ON Parameters

DA7280 Performance Board

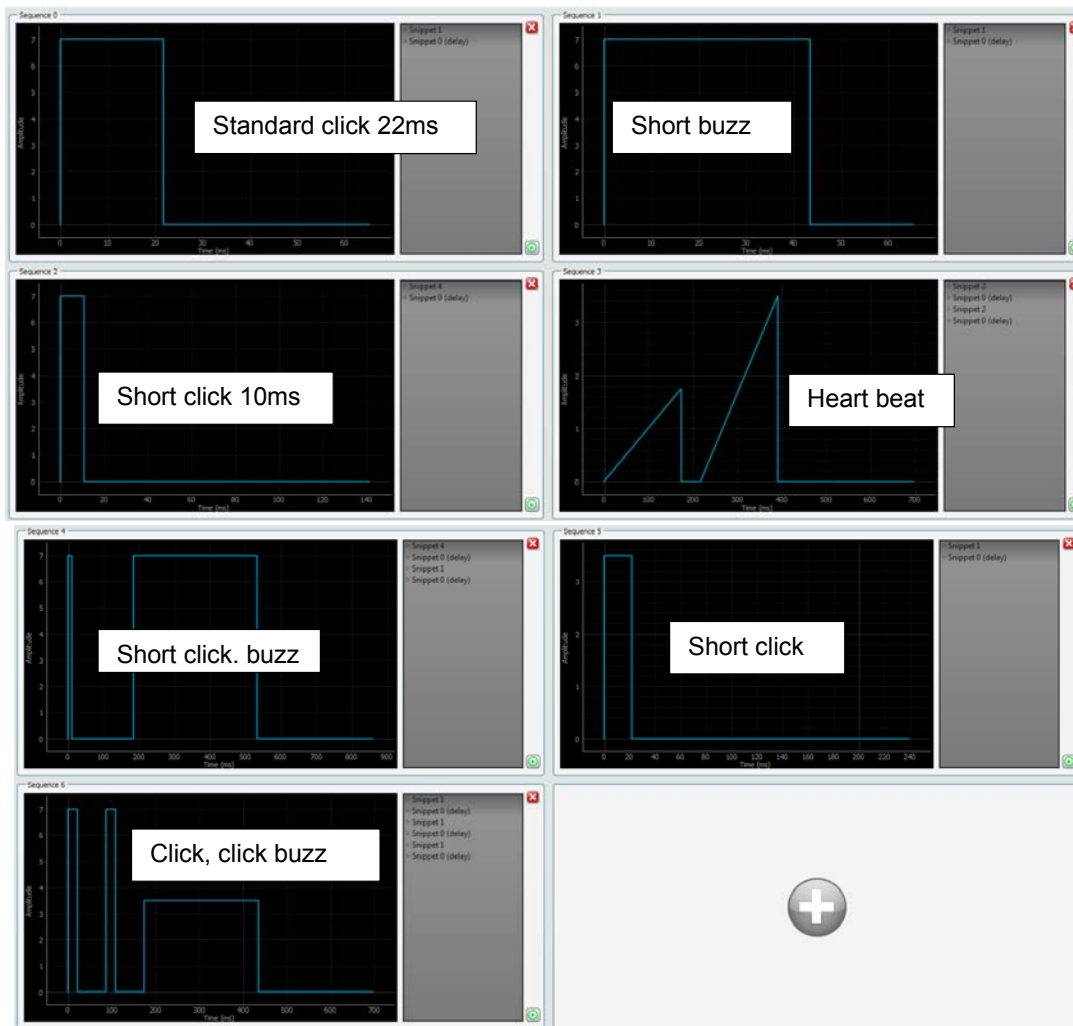

Figure 20: JAHWA\_1040\_FREQ\_TRACK\_ON\_RS\_ON Sequences

The haptic sequences loaded from the setup scripts are displayed in the GUI, see Section 7.3. For the JAHWA\_1040\_FREQ\_TRACK\_ON\_RS\_ON script, the sequences are shown in Figure 20 .

DA7280 Performance Board

7.1.3.3 JAHWA\_1040\_FREQ\_TRACK\_OFF\_SINE

This script drives the output in sinewave mode. This mode reduces the LRA's audibility by driving a sine wave rather than square waves.

Frequency tracking is off; see Table 3, and the Waveform Memory sequences specify the drive frequency to allow wideband haptic effects.

Table 3: JAHWA\_1040\_FREQ\_TRACK\_OFF\_SINE script features:

Feature	Status
Frequency tracking	OFF
Acceleration	OFF
Rapid stop	OFF

After the scripts have loaded, the GUI shows the parameter settings as applied by the setup script see Figure 21.

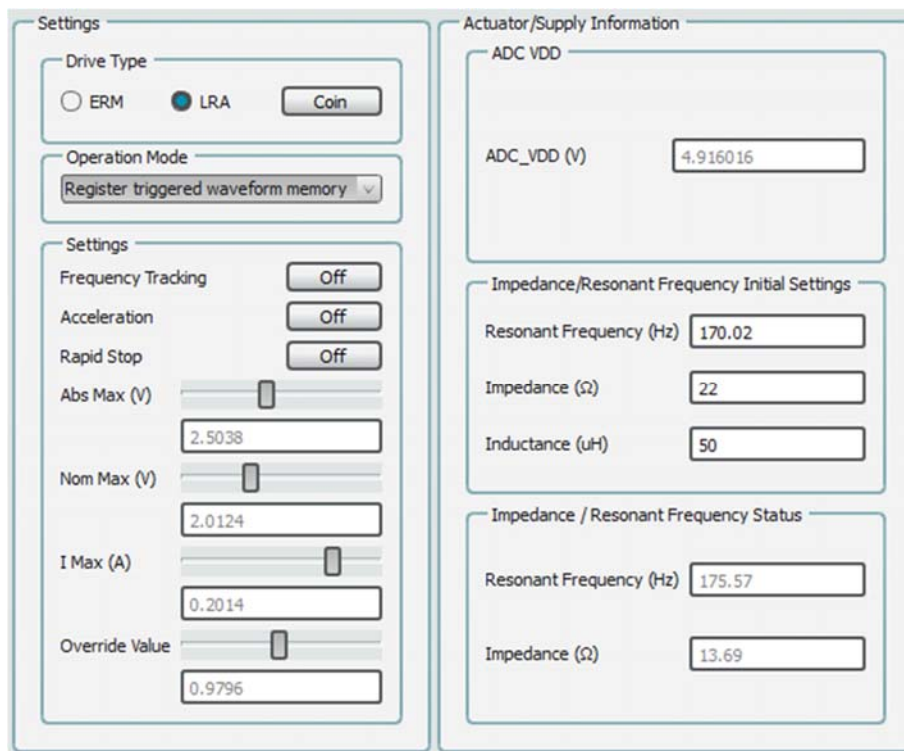

Figure 21: JAHWA\_1040\_FREQ\_TRACK\_OFF\_SINE Parameters

DA7280 Performance Board

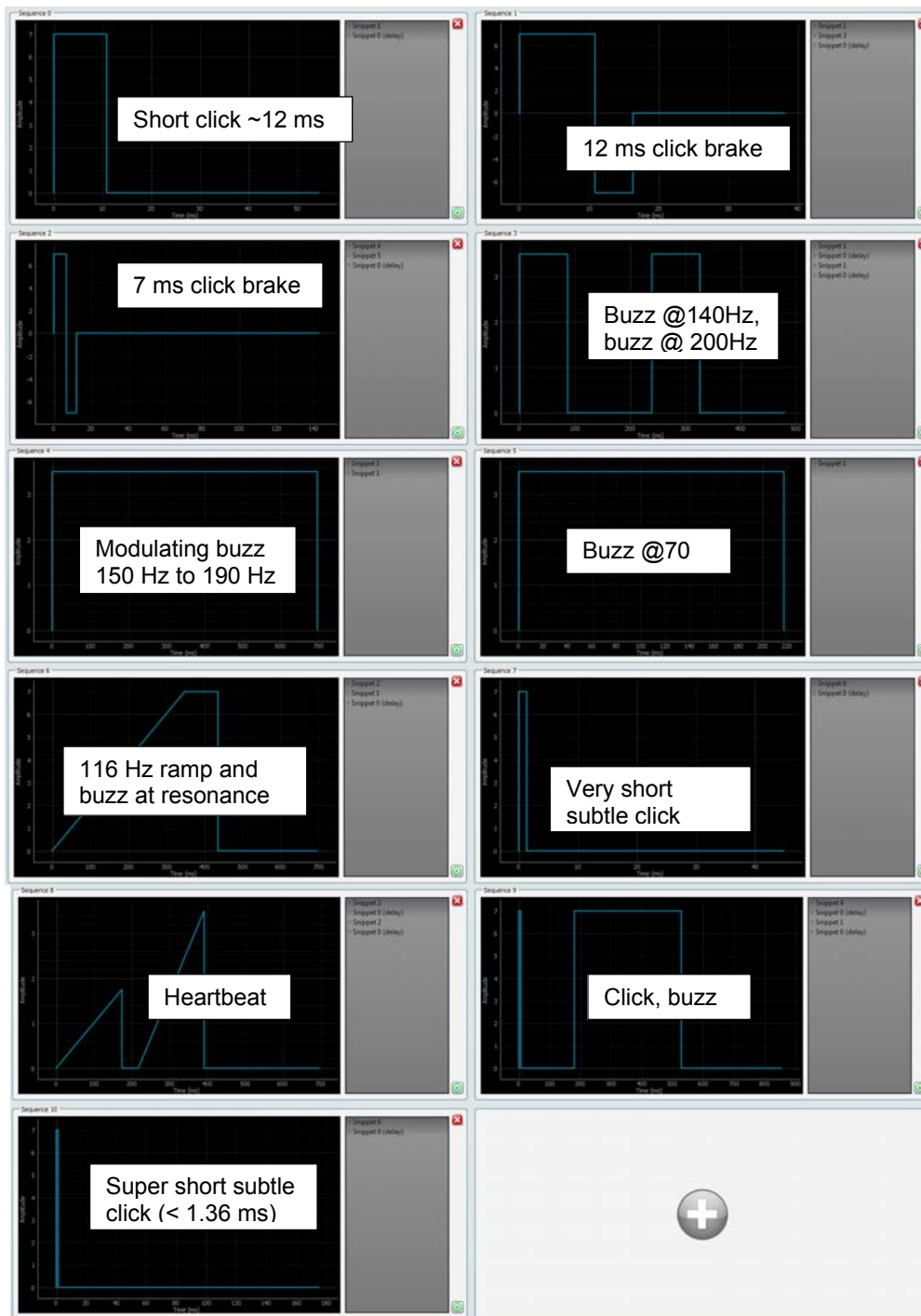

Figure 22: JAHWA\_1040\_FREQ\_TRACK\_OFF\_SINE Sequences

The haptic sequences loaded from the setup scripts are displayed in the GUI, see Section 7.3. For the JAHWA\_1040\_FREQ\_TRACK\_ON\_RS\_ON script, the sequences are shown in Figure 22.

DA7280 Performance Board

7.2 Operating Modes

To select different modes for driving the LRA:

1. In **Drive Type**, select **LRA**, see [Figure 23](#).
2. Use the drop-down menu in **Operation Mode** to select the required mode, see [Figure 24](#). Each Operation Mode is described in detail in the following sub-sections.

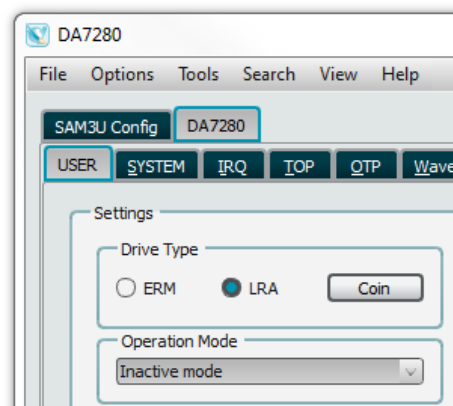

Figure 23: Drive Type

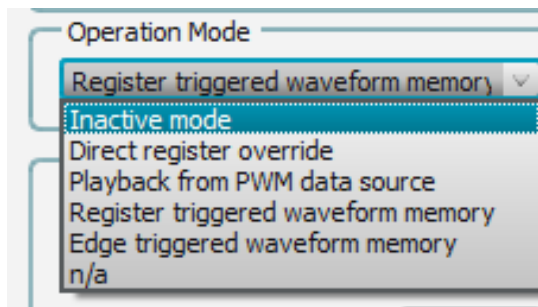

Figure 24: Operation Mode

## DA7280 Performance Board

### 7.2.1 Direct Register Override Mode (DRO)

In DRO mode haptic sequences are streamed to DA7280 via I2C input. The drive level of the output is set via Override value.

To use direct register override (DRO) mode:

1. In **Drive Type**, select **LRA**, see [Figure 25](#).
2. Set the **Override** value.
3. Use the drop-down menu in **Operation Mode** to select **Direct register override**.

Setting the **Override** value and then setting the operating mode to **Direct register override** ensures optimal latency.

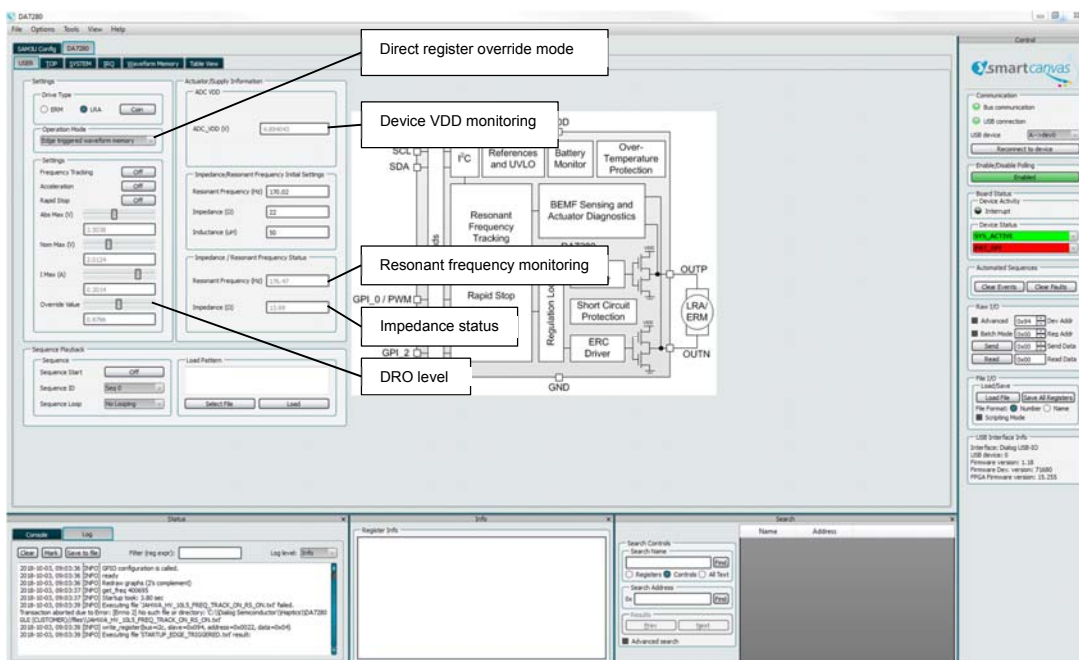

Figure 25: GUI in DRO Mode

### 7.2.2 Register Triggered Waveform Memory (RTWM)

This mode allows the user to trigger haptic sequences stored in the Waveform Memory by using I<sup>2</sup>C writes to DA7280.

1. In **Drive Type**, select **LRA**, see [Figure 26](#).
2. Use the drop-down menu in **Operation Mode** to select **Register triggered waveform memory**.
3. In the **Pattern** window, use the drop-down menu in **Sequence ID** to select a sequence.
4. Click the **Sequence Start** button to trigger the chosen sequence.

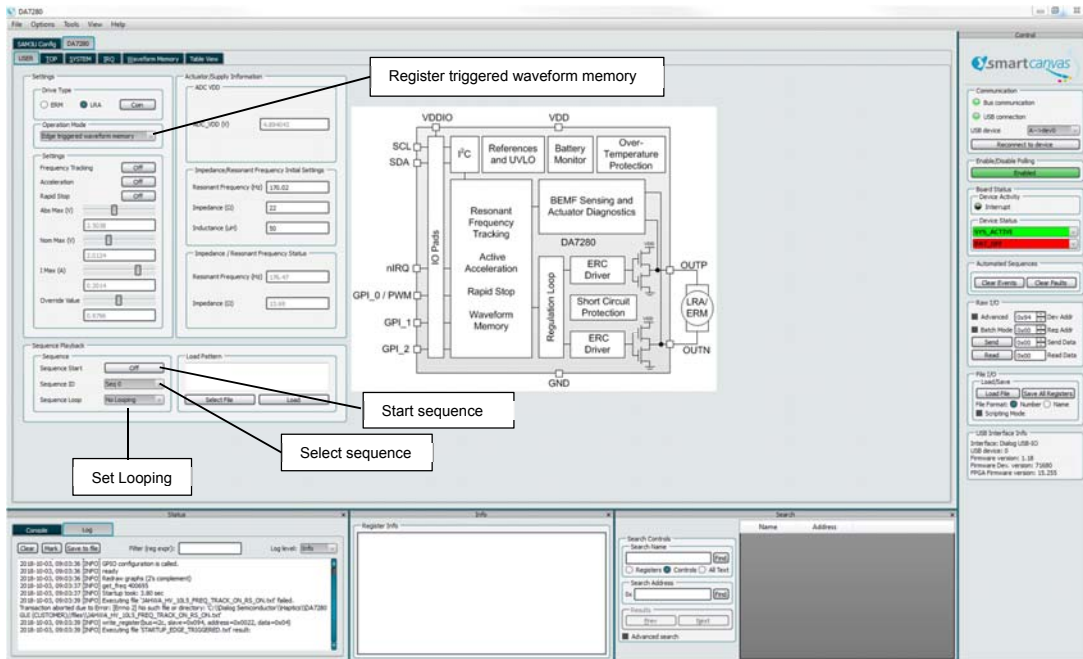

Figure 26: GUI in RTWM Mode

The haptic sequences in the Waveform Memory can be edited, created, and triggered from the Waveform memory editor, see [Section 7.3](#).



## DA7280 Performance Board

### 7.2.3 Pulse Width Modulation Mode (PWM)

PWM mode is used to stream haptic sequences to DA7280 via the GPI\_0/PWM input pin where the output drive level is determined by the duty cycle of the PWM signal. The PWM signal contains envelope information only and the input PWM frequency is unrelated to the output PWM frequency or the resonant frequency setting. The duty cycle is interpreted differently depending if the **Acceleration** is enabled or disabled - see datasheet sections **Pulse Width Modulation Mode** and **General Data Format** for more details.

To drive the LRA in PWM mode:

1. Set the input PWM frequency to the lower end of the allowable range, 10 kHz to 250 kHz.
2. Actively drive the PWM signal via the GPI\_0/PWM pin.
3. In the **Impedance/Resonant Frequency Initial Settings** window of the GUI, set the resonant frequency and impedance of the LRA.

**Note:** Before selecting this mode, the PWM signal must be actively driving the GPI\_0/PWM pin otherwise DA7280 will generate an IRQ, which must be cleared manually.

### 7.2.4 Edge Triggered Waveform Memory (ETWM)

In edge triggered waveform memory (ETWM) mode rising or falling edges, or both rising and falling edges, on GPI\_0/PWM, GPI\_1, and GPI\_2 pins trigger sequences from Waveform Memory, see Section 7.3. Set the registers shown in [Figure 27](#) as required. See also section 7.6.

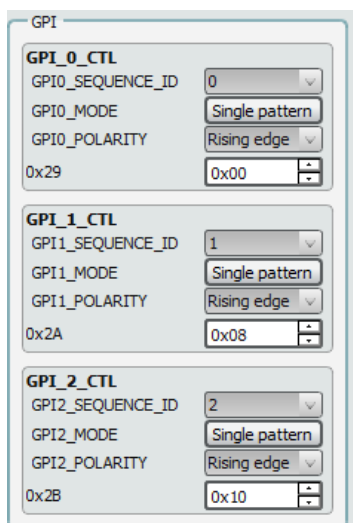

GPI	
<b>GPI_0_CTL</b>	
GPI0_SEQUENCE_ID	0
GPI0_MODE	Single pattern
GPI0_POLARITY	Rising edge
0x29	0x00
<b>GPI_1_CTL</b>	
GPI1_SEQUENCE_ID	1
GPI1_MODE	Single pattern
GPI1_POLARITY	Rising edge
0x2A	0x08
<b>GPI_2_CTL</b>	
GPI2_SEQUENCE_ID	2
GPI2_MODE	Single pattern
GPI2_POLARITY	Rising edge
0x2B	0x10

Figure 27: GPI Registers

DA7280 Performance Board

7.3 Waveform Memory Editor

The Waveform Memory editor is a powerful and intuitive tool for creating haptic effects stored in memory. Haptic effects in Waveform Memory are modified and viewed by selecting **Tools -> Waveform Memory Editor**, see [Figure 28](#).

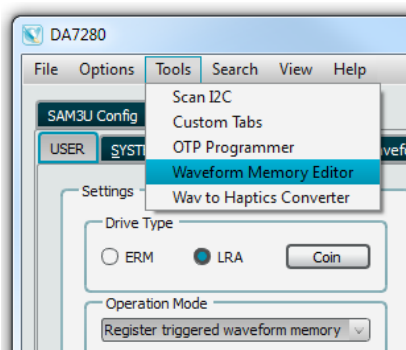

Figure 28: Enabling the Waveform Memory Editor

**Note:** Before proceeding, select **Register Sync -> Read from Device** to read back the Waveform Memory from DA7280.

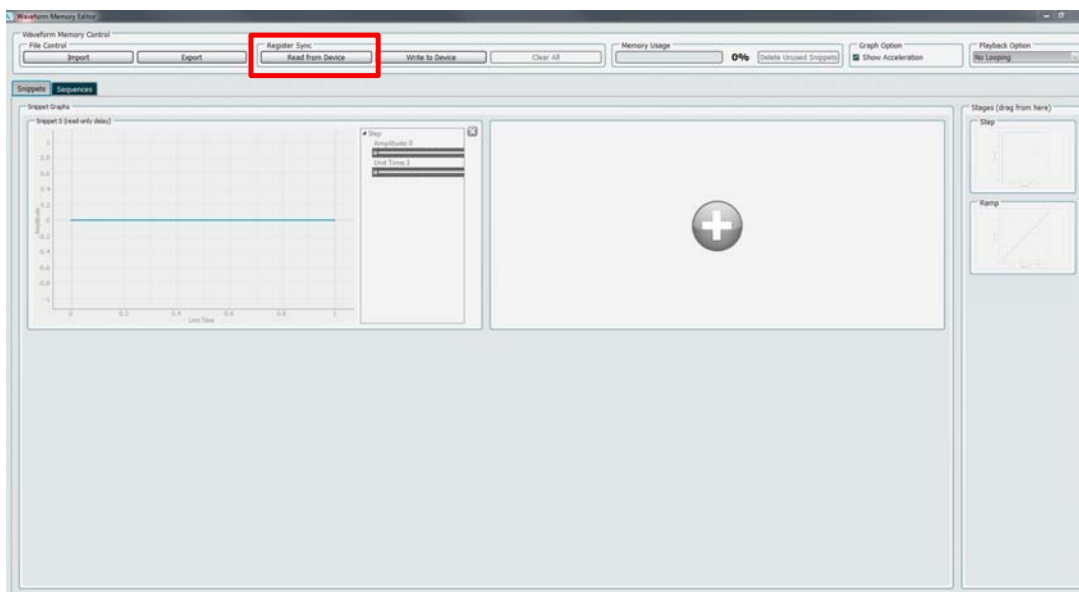

Figure 29: Register Syncing from DA7280 Memory

## DA7280 Performance Board

### 7.3.1 Setting Operation Mode

To trigger haptic sequences:

1. Select the **USER** tab
2. Use the drop-down menu in **Operation Mode** to select **Register triggered waveform memory**.

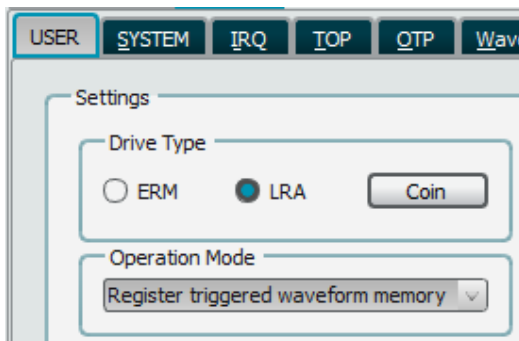

Figure 30: Set RTWM Mode in Operation Mode

### 7.3.2 Snippets Tab

In the Snippets tab, delete, create, and modify snippets by dragging and dropping the basic **Step** and **Ramp** piecewise-linear (PWL) snippets from the **Stages** window into the **Snippets** window. The time and amplitude parameters of each snippet can then be changed in the GUI.

**Note:** Snippets cannot be played directly the haptic effects can only be triggered once the snippet is added to the sequence memory.

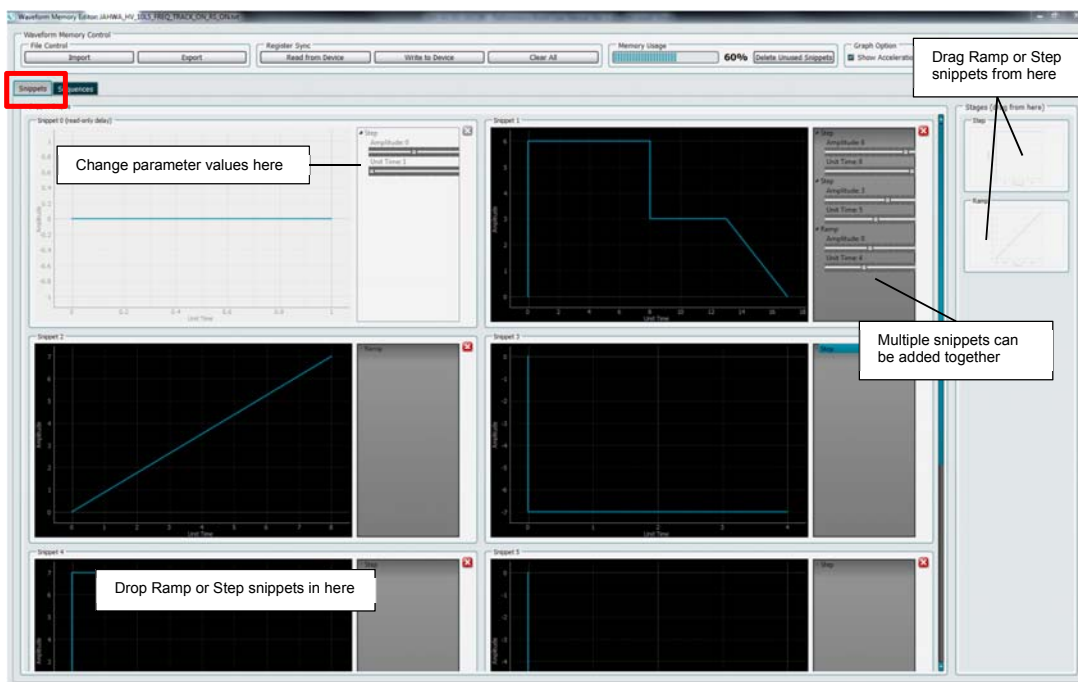

Figure 31: Waveform Memory Editor Snippets Tab

DA7280 Performance Board

7.3.3 Sequences Tab

After dragging and dropping snippets to create haptic sequences, the haptic sequences are played by clicking the green play buttons in the **Sequences** tab, see Figure 32. The played sequence can be looped by changing using the drop-down menu in **Playback Option**. To change the sequence name, click on the sequence identifier.

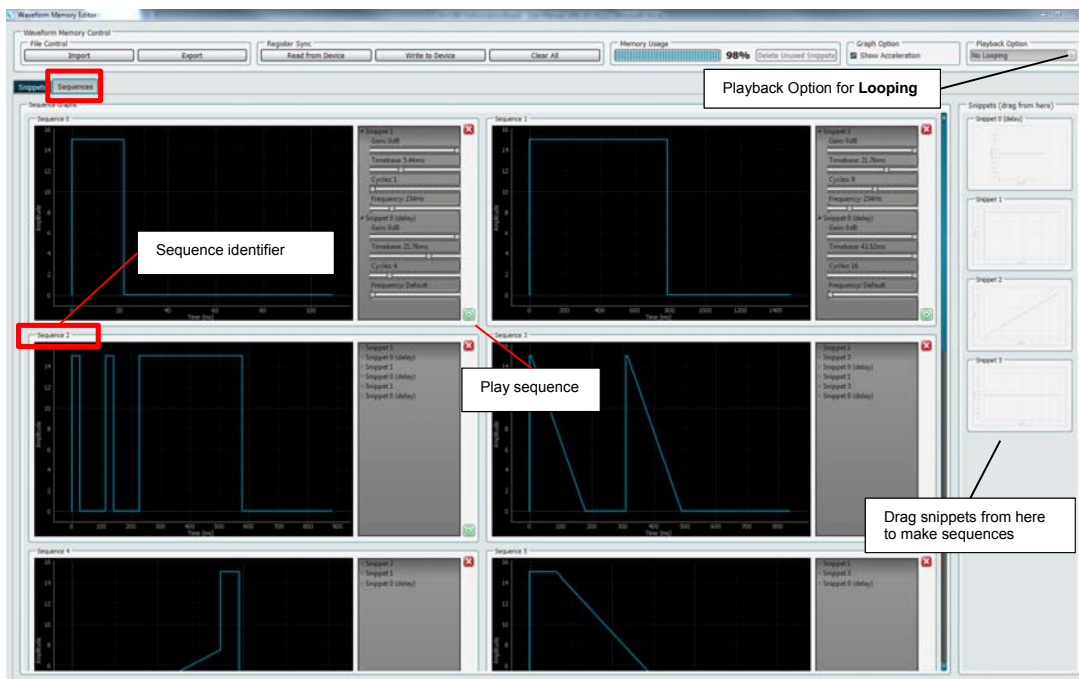

Figure 32: Waveform Memory Editor Sequences Tab

DA7280 Performance Board

7.3.3.1 Changing Snippet Parameter Values

When the snippet is added to the sequence the user can control four snippet parameters:

- **Gain:** The gains that can be applied to the snippets are 0 db, -6 dB, -12 dB and -18 dB.
- **Timebase:** The unit time of the snippet depends on the `FREQ_WAVEFORM_TIMEBASE` bit of register `SEQ_CTL1`. It can be (5.44, 21.76, 43.52, 87.04) ms or (1.36, 5.44, 21.76, 43.52) ms.
- **Cycles:** The snippet can be 1 cycle to 16 cycles.
- **Frequency Default:** From 26 Hz to 1024 Hz; If set to **Default**, the current frequency setting is used. Note that if using this for wideband patterns, frequency tracking should be switched off.

**Note:** The overall time of each sequence = Unit Time \* Cycles \* Timebase.

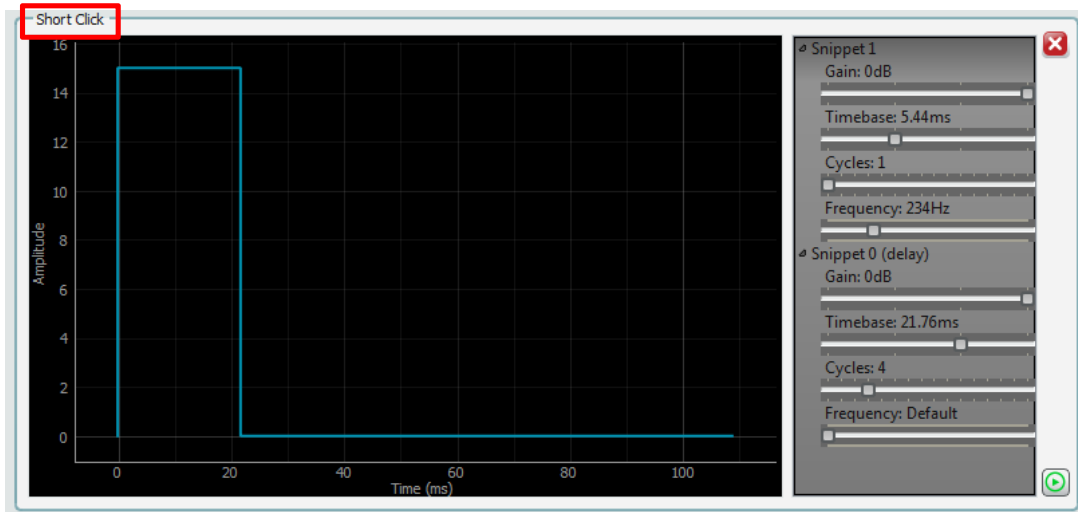

Figure 33: Two Snippet Sequence Example

Sequence Short Click, see Figure 33, is made up of Snippet 1 and Snippet 0, see Figure 34.

- Snippet 1 has an amplitude of 15 and a unit time of 4 ms. The overall time is:

$$4 * 5.44 \text{ ms} * 1 = 21.76 \text{ ms}$$

- Snippet 0 has an amplitude of 0 and a unit time of 1. This is silence for an overall time of:

$$1 * 21.76 \text{ ms} * 4 = 87.04 \text{ ms}$$

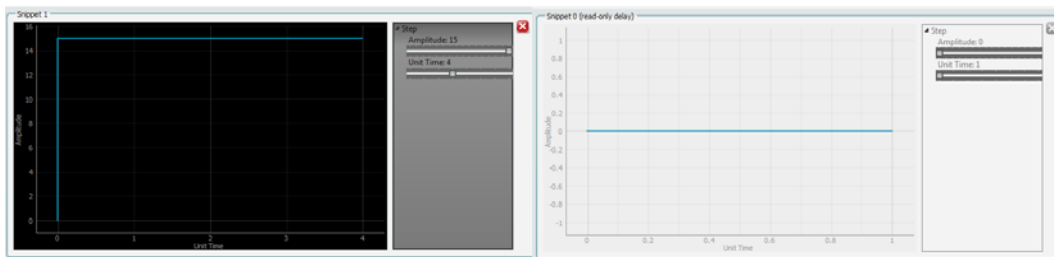

Figure 34: Snippets for the Two Snippet Sequence Example

DA7280 Performance Board

7.4 Wav to Haptics Converter

The Wav to Haptics converter allows .wav files to be converted to haptic patterns and the audio and haptic effect can be played back simultaneously.

Select **Wav to Haptics Converter** from the **Tools** menu and the press the **Load File** button.

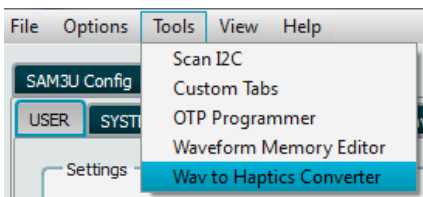

Figure 35: Launching Wav to Haptics Converter

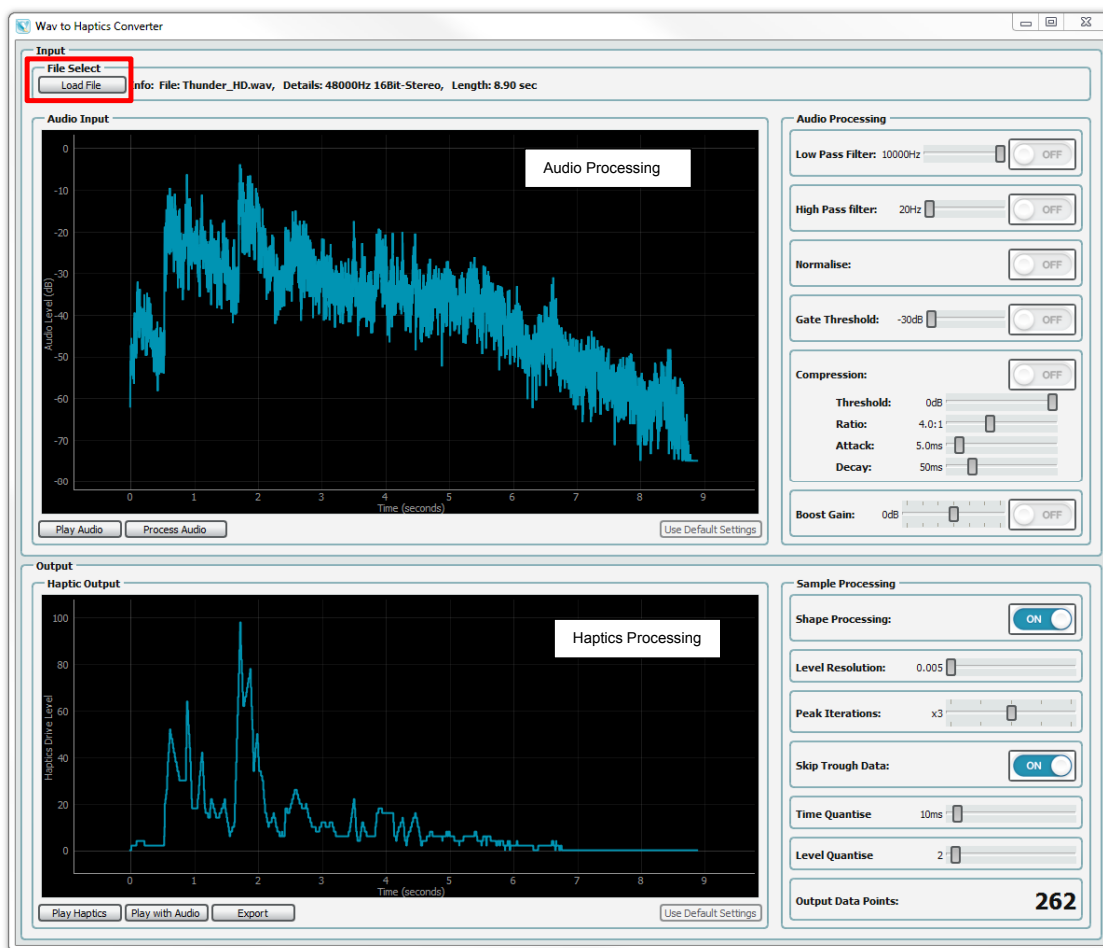

Figure 36: Wav To Haptics Converter Plugin

## DA7280 Performance Board

- Load File
  - The GUI will navigate to the **test\_audio** folder bundled with the GUI. A number of sound effects .wav file are included for demonstration purposes.

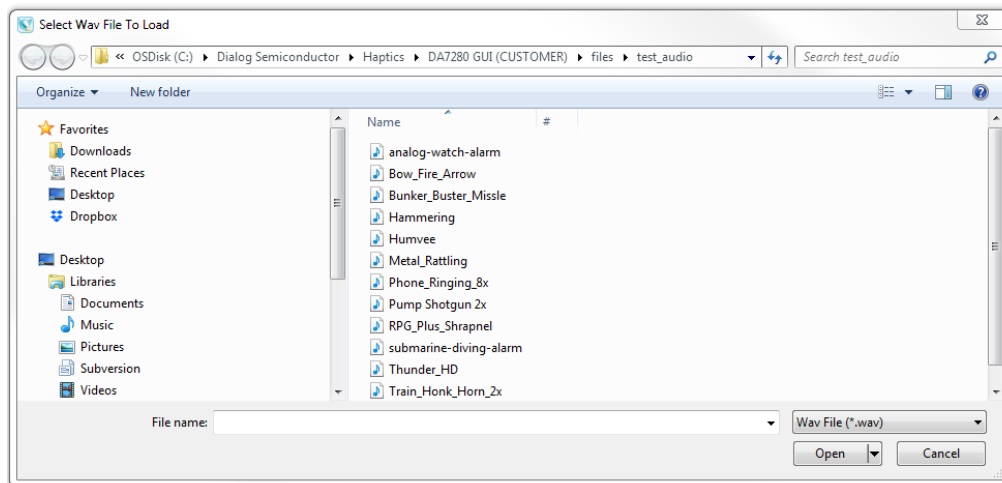

Figure 37: Included Sound Effect Files

- Play Audio
  - Plays the audio track through the computers soundcard.
- Process Audio
  - The audio can be processed with the plug-ins basic filters these include low-pass filter, high-pass filter, Normalise, Gate Threshold, Compression and Boost Gain.
- Play Haptics
  - Plays the haptic sequence.
- Play with Audio
  - Plays haptic sequence and audio simultaneously.
- Export
  - Exports the haptic sequence as .txt, .csv or .bin file.

**Note:** Hoovering the mouse cursor over the GUI's sliders shows detailed description of each control.

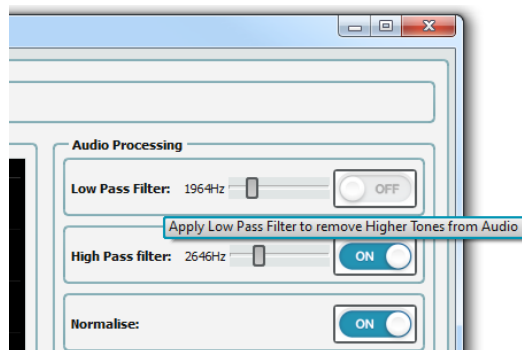

Figure 38: Detailed Descriptions of Controls

DA7280 Performance Board

7.5 IRQ

Interrupt requests in the form of events and warnings can occur in normal operation. To continue driving the LRA, these must be cleared in the GUI.

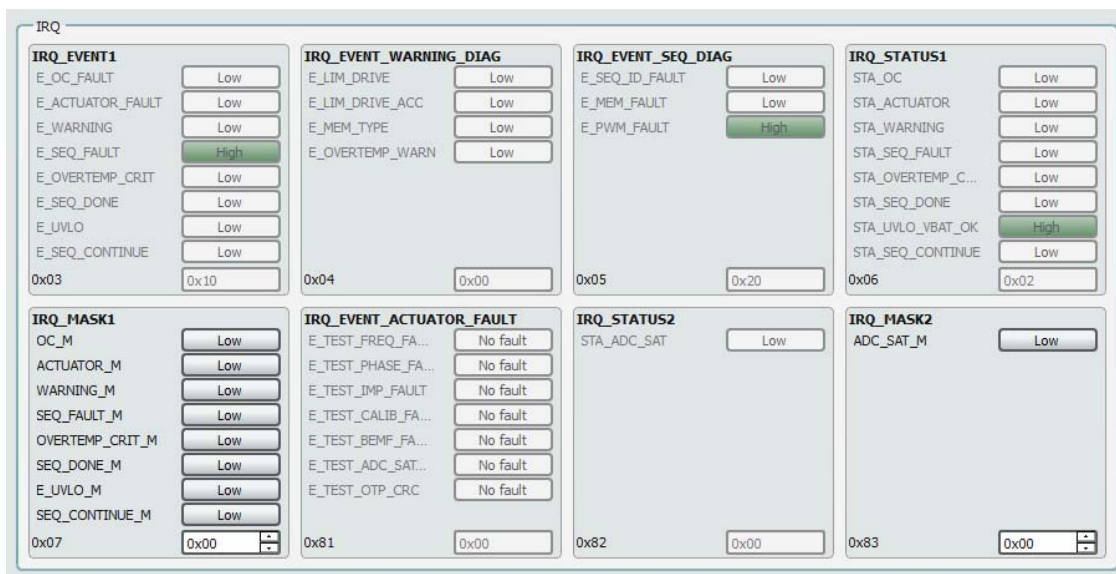

Figure 39: IRQ Tab

To clear IRQ faults events click on buttons **Clear Events** and **Clear Faults**, see Figure 40.

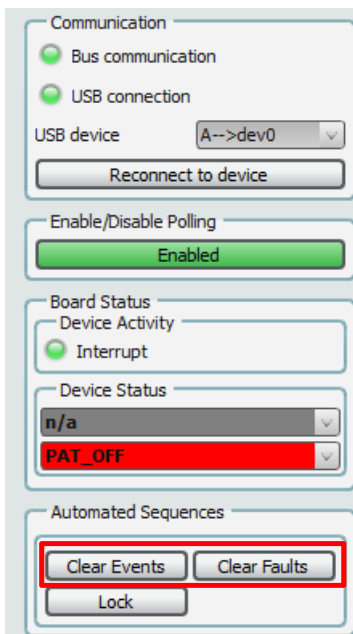
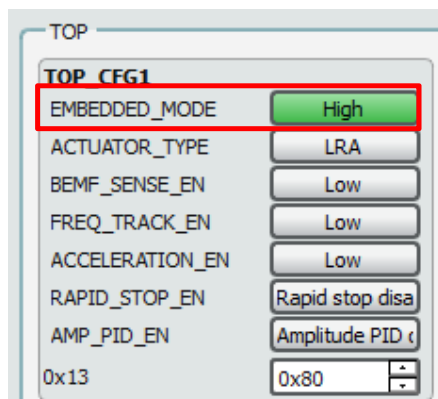

Figure 40: Clear IRQ Events and Faults



## DA7280 Performance Board

**Note:** In Embedded Mode operation, see [Figure 41](#), the IRQs will self-clear when the playback ends. This is useful for systems with minimum interaction between the host and DA7280.



**Figure 41: Embedded Mode**

DA7280 Performance Board

7.6 Cap Sense Setup

The USB to I2C controller can be configured to ensure the USB does not interfere with the cap sense buttons. Set the IO Mode to **Input: High-Z** in the **Sam3U Config** tab, see [Figure 42](#).

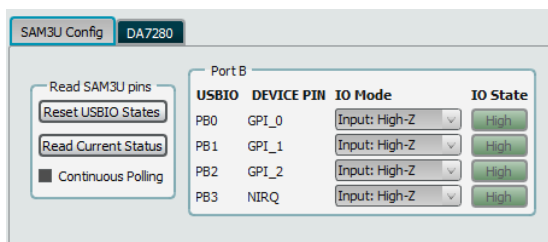

Figure 42: SAM3U Configuration

Now set the operation mode to **ETWM** mode, see [Figure 43](#).

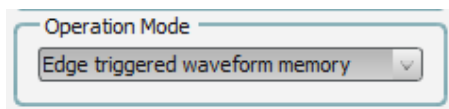

Figure 43: ETWM Mode

Set the GPI controls as required for user defined operation. In this case **GPI0\_POLARITY** is set to **Falling edge** triggered, and **GPI0\_SEQUENCE\_ID** is set to **0**, see [Figure 44](#). On receiving a falling edge on **GPI\_0** pin the first haptic sequence in the Waveform Memory will be triggered.

**Note:** The cap sense buttons voltage levels are high by default; pressing cap sense button pulls the line to ground triggering GPI 0 on the falling edge. Triggering on the rising edge would mean that on releasing the cap sense button the sequence would be triggered. A third option is to trigger on either rising or falling edges.

In **Multi sequence** mode, the rising edge will trigger the sequence denoted by **SEQUENCE\_ID**, while the falling edge will trigger the sequence located at **SEQUENCE\_ID + 1**.

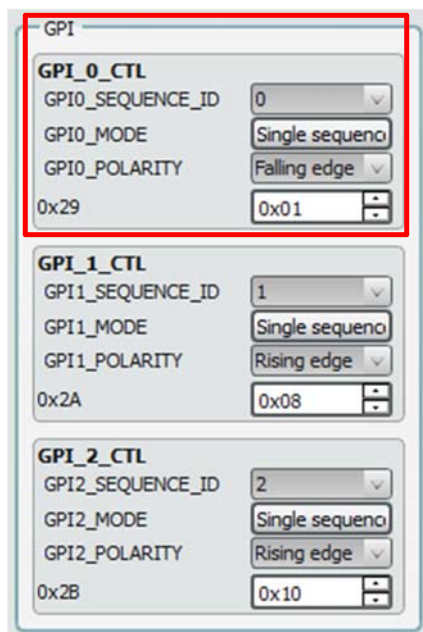

Figure 44: GPI\_0\_CTL Settings

DA7280 Performance Board

7.7 GPI Triggering from GUI

The GPIs can be controlled from the GUI's **SAM3U Config** tab by setting the **IO Mode** to **Output** and pressing the **IO State** button, see [Figure 45](#).

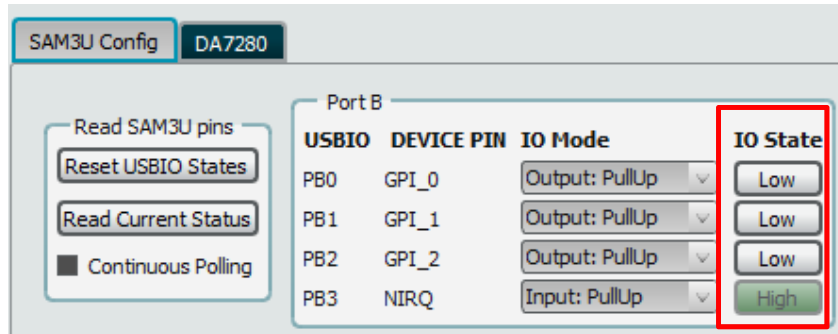

Figure 45: Controlling GPIs from GUI

## DA7280 Performance Board

### 8 Monitoring Drive Signals and Measuring Acceleration

When evaluating the system performance of the haptic driver and the LRA and for general tuning purposes, it is useful to go through the following procedure:

1. Place the DA7280 Performance Board on foam to isolate it from hard surfaces. This reduces damping of the LRA's motion.
2. Connect the oscilloscope channels 1 and 2 (yellow and green trace) to header J2 to monitor the filtered OUTP and OUTN signals. The filter cut-off is set at  $\sim 3.3$  kHz.
3. The unfiltered OUTP and OUTN signals (header J4) are PWM signals at 187.5 kHz so looking at these makes little sense for analysis purposes.
4. Connect oscilloscope channel 3 (blue trace) to the header J1 and chose a suitable accelerometer axis which is depending on type of actuator, in this case the Z-AXIS.
5. Set the oscilloscopes trigger channel to trigger on the rising edge of channel 1. Now drive haptic patterns and observe the acceleration while also feeling the movement of the LRA with your hand.
6. The default 100nF caps (C13, C14, and C16) on the output accelerometer circuit set the bandwidth to be 50Hz. With  $VDD=1.8V$ , 1 g peak of acceleration is  $\sim 50$  mV (peak).
  - a. For higher resolution measurements for this accelerometer changing these caps to 10nF is advisable. 1g of peak acceleration would then be  $\sim 150mV$  at 1.8V VDDIO.

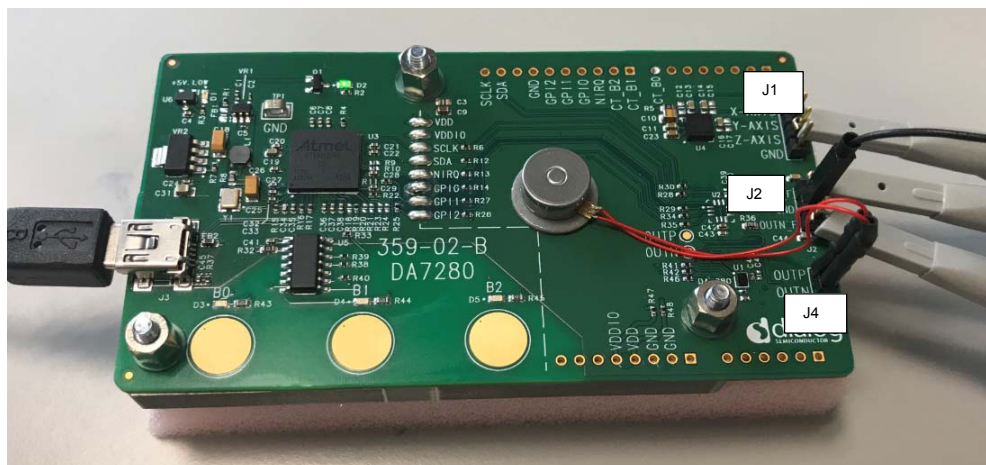

Figure 46: Monitoring Signals

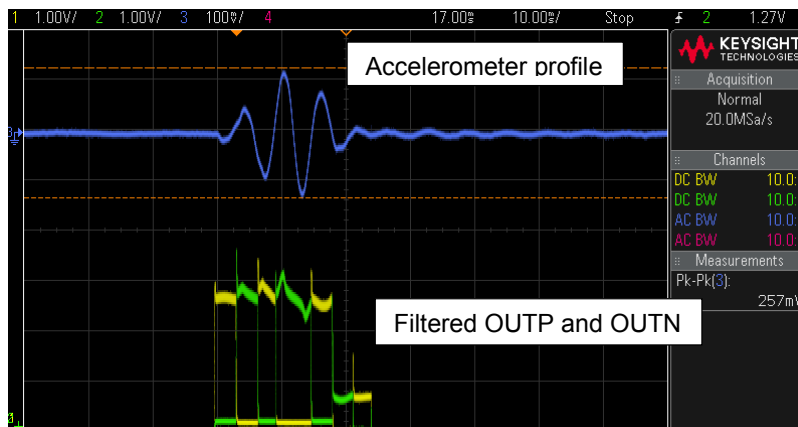

Figure 47: Measured Output Signals and Acceleration Profile

## DA7280 Performance Board

### 9 Measuring current

To measure the current taken by the VDD supply the following hardware modifications should be made to the Performance Board - see [Figure 48: Measuring current board modifications](#)

1. Unsolder VDD solder bump, this isolates the DA7280 VDD Power supply from the USB supply.
2. Externally supply VDD at 3.7 Volts and GND to the Power Connections header.
3. If the GUI is connected to DA7280 ensure Polling Enabled/Disabled button is disabled.

To measure VDDIO supply, the following modifications should be made.

4. Unsolder the following solder bumps to isolate VDDIO supply – VDDIO, SCLK, SDA, NIRQ, GPIO, GPI0, GPI1, and GPI2.
5. Remove R5, powers down accelerometer.
6. Remove R32, powers down Cap Sense circuitry.
7. If the GUI is connected to DA7280 ensure Polling Enabled/Disabled button is disabled.

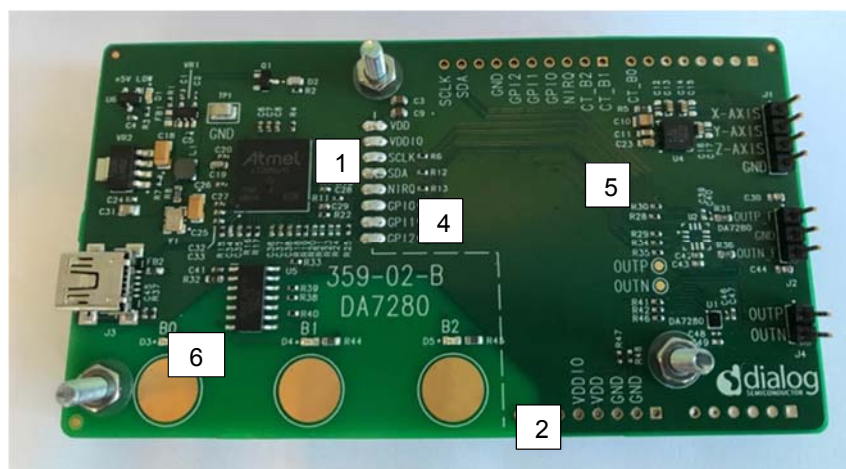

## Revision History

Revision	Date	Description
1.0	26-Mar-2018	Initial version
1.1	18-April-2018	Updated scripts section.
1.2	14-August-2018	Updated sections 8 and 9.
1.3	03-October-2018	Changed Jahwa script names to 1040. DA7280 GUI UI updated.

## DA7280 Performance Board

### Status Definitions

Status	Definition
DRAFT	The content of this document is under review and subject to formal approval, which may result in modifications or additions.
APPROVED or unmarked	The content of this document has been approved for publication.

### Disclaimer

Information in this document is believed to be accurate and reliable. However, Dialog Semiconductor does not give any representations or warranties, expressed or implied, as to the accuracy or completeness of such information. Dialog Semiconductor furthermore takes no responsibility whatsoever for the content in this document if provided by any information source outside of Dialog Semiconductor.

Dialog Semiconductor reserves the right to change without notice the information published in this document, including without limitation the specification and the design of the related semiconductor products, software and applications.

Applications, software, and semiconductor products described in this document are for illustrative purposes only. Dialog Semiconductor makes no representation or warranty that such applications, software and semiconductor products will be suitable for the specified use without further testing or modification. Unless otherwise agreed in writing, such testing or modification is the sole responsibility of the customer and Dialog Semiconductor excludes all liability in this respect.

Customer notes that nothing in this document may be construed as a license for customer to use the Dialog Semiconductor products, software and applications referred to in this document. Such license must be separately sought by customer with Dialog Semiconductor.

All use of Dialog Semiconductor products, software and applications referred to in this document are subject to Dialog Semiconductor's [Standard Terms and Conditions of Sale](http://www.dialog-semiconductor.com), available on the company website ([www.dialog-semiconductor.com](http://www.dialog-semiconductor.com)) unless otherwise stated.

Dialog and the Dialog logo are trademarks of Dialog Semiconductor plc or its subsidiaries. All other product or service names are the property of their respective owners.

© 2018 Dialog Semiconductor. All rights reserved.

### Contacting Dialog Semiconductor

#### United Kingdom

(Headquarters)

Dialog Semiconductor (UK)

LTD

Phone: +44 1793 757700

#### Germany

Dialog Semiconductor

GmbH

Phone: +49 7021 805-0

#### The Netherlands

Dialog Semiconductor B.V.

Phone: +31 73 640 8822

#### Email:

[enquiry@diasemi.com](mailto:enquiry@diasemi.com)

#### North America

Dialog Semiconductor Inc.

Phone: +1 408 845 8500

#### Japan

Dialog Semiconductor K. K.

Phone: +81 3 5769 5100

#### Taiwan

Dialog Semiconductor

Taiwan

Phone: +886 281 786 222

#### Web site:

[www.dialog-semiconductor.com](http://www.dialog-semiconductor.com)

#### Hong Kong

Dialog Semiconductor Hong

Kong

Phone: +852 2607 4271

#### Korea

Dialog Semiconductor Korea

Phone: +82 2 3469 8200

#### China (Shenzhen)

Dialog Semiconductor

China

Phone: +86 755 2981

3669

#### China (Shanghai)

Dialog Semiconductor

China

Phone: +86 21 5424

9058

## IMPORTANT NOTICE AND DISCLAIMER

RENESAS ELECTRONICS CORPORATION AND ITS SUBSIDIARIES (“RENESAS”) PROVIDES TECHNICAL SPECIFICATIONS AND RELIABILITY DATA (INCLUDING DATASHEETS), DESIGN RESOURCES (INCLUDING REFERENCE DESIGNS), APPLICATION OR OTHER DESIGN ADVICE, WEB TOOLS, SAFETY INFORMATION, AND OTHER RESOURCES “AS IS” AND WITH ALL FAULTS, AND DISCLAIMS ALL WARRANTIES, EXPRESS OR IMPLIED, INCLUDING, WITHOUT LIMITATION, ANY IMPLIED WARRANTIES OF MERCHANTABILITY, FITNESS FOR A PARTICULAR PURPOSE, OR NON-INFRINGEMENT OF THIRD-PARTY INTELLECTUAL PROPERTY RIGHTS.

These resources are intended for developers who are designing with Renesas products. You are solely responsible for (1) selecting the appropriate products for your application, (2) designing, validating, and testing your application, and (3) ensuring your application meets applicable standards, and any other safety, security, or other requirements. These resources are subject to change without notice. Renesas grants you permission to use these resources only to develop an application that uses Renesas products. Other reproduction or use of these resources is strictly prohibited. No license is granted to any other Renesas intellectual property or to any third-party intellectual property. Renesas disclaims responsibility for, and you will fully indemnify Renesas and its representatives against, any claims, damages, costs, losses, or liabilities arising from your use of these resources. Renesas' products are provided only subject to Renesas' Terms and Conditions of Sale or other applicable terms agreed to in writing. No use of any Renesas resources expands or otherwise alters any applicable warranties or warranty disclaimers for these products.

(Disclaimer Rev.1.01 Jan 2024)

### Corporate Headquarters

TOYOSU FORESIA, 3-2-24 Toyosu,  
Koto-ku, Tokyo 135-0061, Japan  
[www.renesas.com](http://www.renesas.com)

### Trademarks

Renesas and the Renesas logo are trademarks of Renesas Electronics Corporation. All trademarks and registered trademarks are the property of their respective owners.

### Contact Information

For further information on a product, technology, the most up-to-date version of a document, or your nearest sales office, please visit [www.renesas.com/contact-us/](http://www.renesas.com/contact-us/).