

致尊敬的顾客

关于产品目录等资料中的旧公司名称

NEC电子公司与株式会社瑞萨科技于2010年4月1日进行业务整合（合并），整合后的新公司暨“瑞萨电子公司”继承两家公司的所有业务。因此，本资料中虽还保留有旧公司名称等标识，但是并不妨碍本资料的有效性，敬请谅解。

瑞萨电子公司网址：<http://www.renesas.com>

2010年4月1日
瑞萨电子公司

【发行】瑞萨电子公司（<http://www.renesas.com>）

【业务咨询】<http://www.renesas.com/inquiry>

Notice

1. All information included in this document is current as of the date this document is issued. Such information, however, is subject to change without any prior notice. Before purchasing or using any Renesas Electronics products listed herein, please confirm the latest product information with a Renesas Electronics sales office. Also, please pay regular and careful attention to additional and different information to be disclosed by Renesas Electronics such as that disclosed through our website.
2. Renesas Electronics does not assume any liability for infringement of patents, copyrights, or other intellectual property rights of third parties by or arising from the use of Renesas Electronics products or technical information described in this document. No license, express, implied or otherwise, is granted hereby under any patents, copyrights or other intellectual property rights of Renesas Electronics or others.
3. You should not alter, modify, copy, or otherwise misappropriate any Renesas Electronics product, whether in whole or in part.
4. Descriptions of circuits, software and other related information in this document are provided only to illustrate the operation of semiconductor products and application examples. You are fully responsible for the incorporation of these circuits, software, and information in the design of your equipment. Renesas Electronics assumes no responsibility for any losses incurred by you or third parties arising from the use of these circuits, software, or information.
5. When exporting the products or technology described in this document, you should comply with the applicable export control laws and regulations and follow the procedures required by such laws and regulations. You should not use Renesas Electronics products or the technology described in this document for any purpose relating to military applications or use by the military, including but not limited to the development of weapons of mass destruction. Renesas Electronics products and technology may not be used for or incorporated into any products or systems whose manufacture, use, or sale is prohibited under any applicable domestic or foreign laws or regulations.
6. Renesas Electronics has used reasonable care in preparing the information included in this document, but Renesas Electronics does not warrant that such information is error free. Renesas Electronics assumes no liability whatsoever for any damages incurred by you resulting from errors in or omissions from the information included herein.
7. Renesas Electronics products are classified according to the following three quality grades: “Standard”, “High Quality”, and “Specific”. The recommended applications for each Renesas Electronics product depends on the product’s quality grade, as indicated below. You must check the quality grade of each Renesas Electronics product before using it in a particular application. You may not use any Renesas Electronics product for any application categorized as “Specific” without the prior written consent of Renesas Electronics. Further, you may not use any Renesas Electronics product for any application for which it is not intended without the prior written consent of Renesas Electronics. Renesas Electronics shall not be in any way liable for any damages or losses incurred by you or third parties arising from the use of any Renesas Electronics product for an application categorized as “Specific” or for which the product is not intended where you have failed to obtain the prior written consent of Renesas Electronics. The quality grade of each Renesas Electronics product is “Standard” unless otherwise expressly specified in a Renesas Electronics data sheets or data books, etc.
 - “Standard”: Computers; office equipment; communications equipment; test and measurement equipment; audio and visual equipment; home electronic appliances; machine tools; personal electronic equipment; and industrial robots.
 - “High Quality”: Transportation equipment (automobiles, trains, ships, etc.); traffic control systems; anti-disaster systems; anti-crime systems; safety equipment; and medical equipment not specifically designed for life support.
 - “Specific”: Aircraft; aerospace equipment; submersible repeaters; nuclear reactor control systems; medical equipment or systems for life support (e.g. artificial life support devices or systems), surgical implantations, or healthcare intervention (e.g. excision, etc.), and any other applications or purposes that pose a direct threat to human life.
8. You should use the Renesas Electronics products described in this document within the range specified by Renesas Electronics, especially with respect to the maximum rating, operating supply voltage range, movement power voltage range, heat radiation characteristics, installation and other product characteristics. Renesas Electronics shall have no liability for malfunctions or damages arising out of the use of Renesas Electronics products beyond such specified ranges.
9. Although Renesas Electronics endeavors to improve the quality and reliability of its products, semiconductor products have specific characteristics such as the occurrence of failure at a certain rate and malfunctions under certain use conditions. Further, Renesas Electronics products are not subject to radiation resistance design. Please be sure to implement safety measures to guard them against the possibility of physical injury, and injury or damage caused by fire in the event of the failure of a Renesas Electronics product, such as safety design for hardware and software including but not limited to redundancy, fire control and malfunction prevention, appropriate treatment for aging degradation or any other appropriate measures. Because the evaluation of microcomputer software alone is very difficult, please evaluate the safety of the final products or system manufactured by you.
10. Please contact a Renesas Electronics sales office for details as to environmental matters such as the environmental compatibility of each Renesas Electronics product. Please use Renesas Electronics products in compliance with all applicable laws and regulations that regulate the inclusion or use of controlled substances, including without limitation, the EU RoHS Directive. Renesas Electronics assumes no liability for damages or losses occurring as a result of your noncompliance with applicable laws and regulations.
11. This document may not be reproduced or duplicated, in any form, in whole or in part, without prior written consent of Renesas Electronics.
12. Please contact a Renesas Electronics sales office if you have any questions regarding the information contained in this document or Renesas Electronics products, or if you have any other inquiries.

(Note 1) “Renesas Electronics” as used in this document means Renesas Electronics Corporation and also includes its majority-owned subsidiaries.

(Note 2) “Renesas Electronics product(s)” means any product developed or manufactured by or for Renesas Electronics.

7548/7549 群

定时器 A 的操作（输出比较功能实现 PWM 输出）

1. 要点

本篇资料介绍如何使用定时器 A 的比较输出功能产生 PWM 波形。

2. 说明

该应用说明适用于以下条件：

采用的 MCU: M37548 群

M37549 群

振荡频率: 8MHz

3. 内容

3.1 PWM 输出波形说明



图 1 PWM 输出波形示意图

● 说明

1. 初始化定时器 A 和输出比较功能，设定 PWM 输出的周期和占空比。
2. 当定时器 A 的计数值与比较锁存器中的值一致时，比较输出触发产生；比较输出波形反转。
3. 在定时器下一次下溢时，比较缓冲器中的新设定值写入比较锁存器，当比较输出触发再次产生后，输出波形反转。
4. 重复输出 10 个周期的 PWM 波形后调整占空比参数。
5. 当比较锁存器中新设定值与定时器计数值一致时，比较输出触发产生；比较输出波形反转。
6. 重复输出 10 个周期，调整了占空比的 PWM 波形。

3.2 PWM 输出波形产生时序图

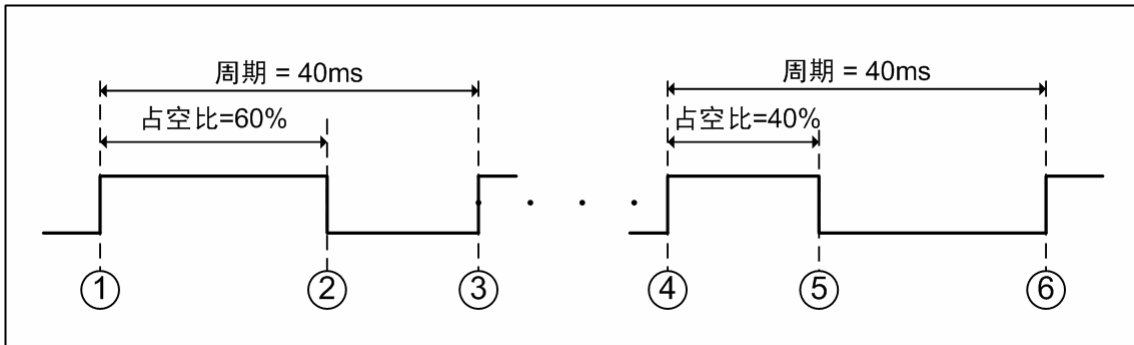

图 2 输出比较功能产生 PWM 波形的时序图

3.3 PWM 参数计算公式

以下公式用于计算 PWM 波形的周期和占空比参数：

$$\text{PWM 周期} = (TA + 1) / f(\text{定时器计数时钟});$$

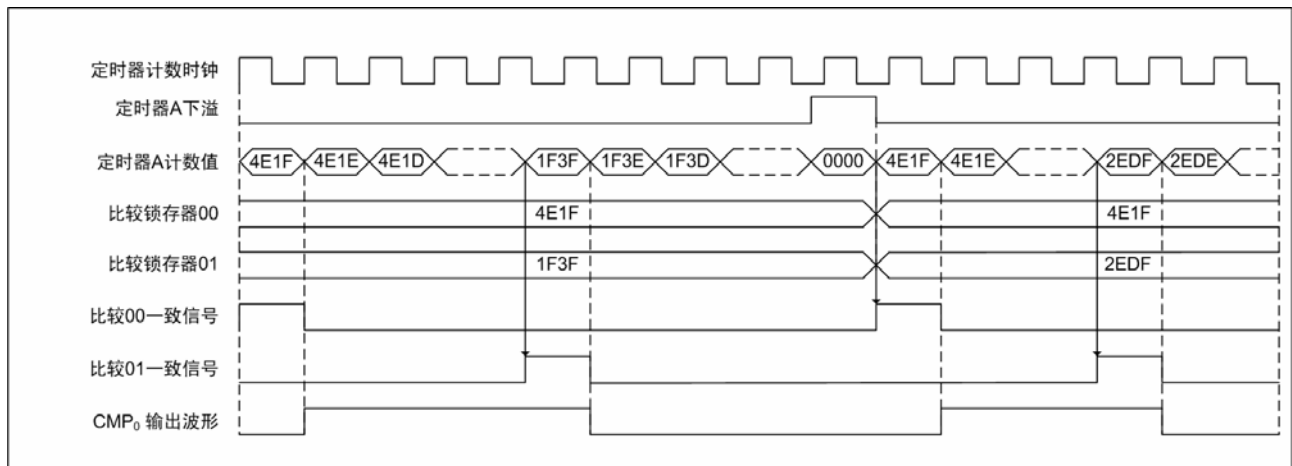
$$\text{输出“H”脉冲占空比} = [(CRAi0 - CRAi1) / (TA + 1)] \times 100\%; \quad (i = 0, 1, 2)$$

注：定时器 A 包括低位（TAL）和高位（TAH）；
CRAi0 和 CRAi1 为输出比较通道 i 的比较锁存器；
输出比较通道 i 选择正极性输出。

3.4 寄存器设置

7548/49 群有 3 个输出比较通道。每个通道 (0~2) 具有相同的功能，并且使用定时器 A 的计数值输出波形。本应用示例中，仅使用了输出比较通道 0 输出 PWM 波形。比较输出功能的设置如下。如果使用输出比较通道 1 或 2 输出 PWM 波形，设置方法是相同的。

(1) 设置端口 P1 方向寄存器

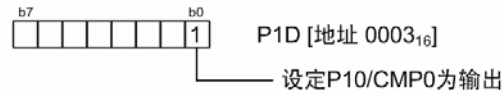

(2) 设置中断控制寄存器

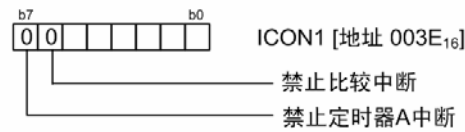

(3) 设置定时器 A 模式寄存器

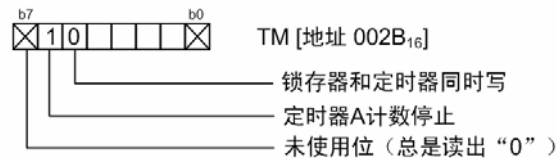

(4) 设置定时器计数源设定寄存器

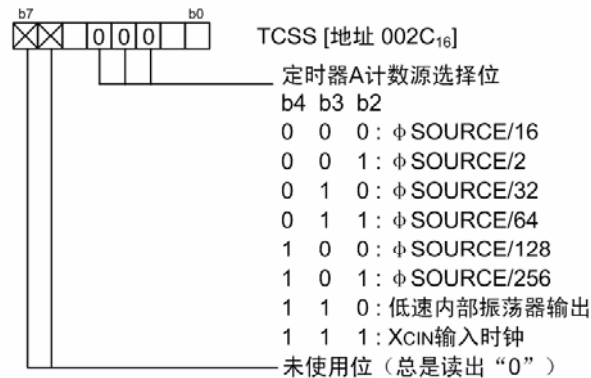

(5) 设置定时器 A 寄存器

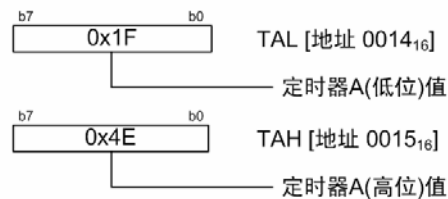

注: 必须按定时器 A 的低位、定时器 A 的高位的顺序, 给 2 个寄存器写。

(6) 设置比较输出模式寄存器

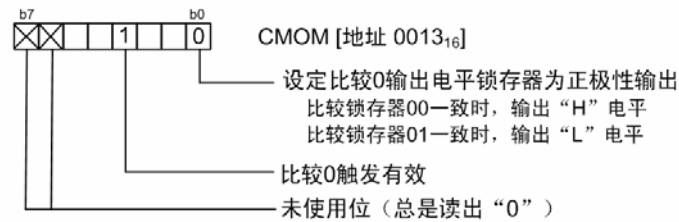

(7) 设置捕捉/比较寄存器R/W指针

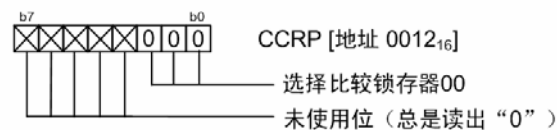

(8) 设置捕捉/比较寄存器

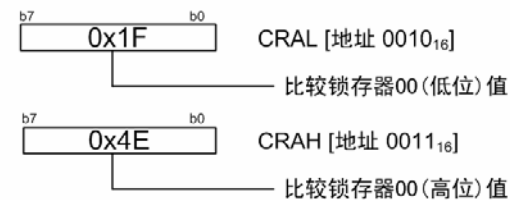

(9) 设置捕捉/比较寄存器R/W指针

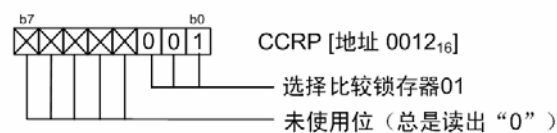

(10) 设置捕捉/比较寄存器

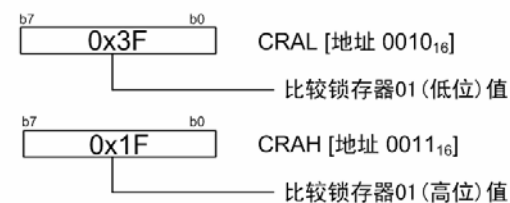

(11) 设置比较设定值再装入寄存器

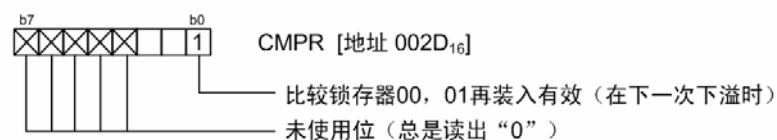

(12) 设置捕捉/比较端口寄存器

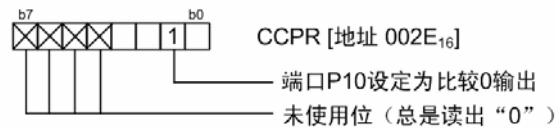

(13) 设置捕捉/比较状态寄存器

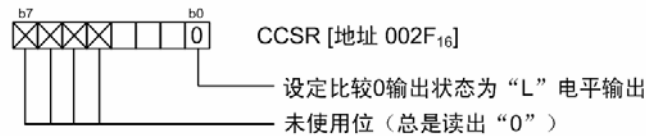

(14) 设置比较中断源设定寄存器



(15) 设置中断请求寄存器

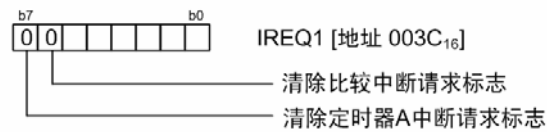

(16) 设置中断控制寄存器

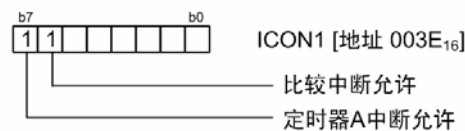

(17) 设置定时器A模式寄存器

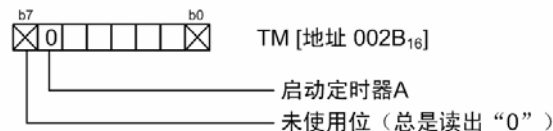

注：在定时器 A 计数期间要改变输出比较通道 0 输出波形时，重复上述步骤（8）～（11）。必须将比较锁存器 00，01 重装入位设置为“1”（下一次下溢时重载入允许），这样就在定时器下一次下溢时，比较缓冲器中的新设定值才写入比较锁存器。

4. 程序流程图

4.1 主程序

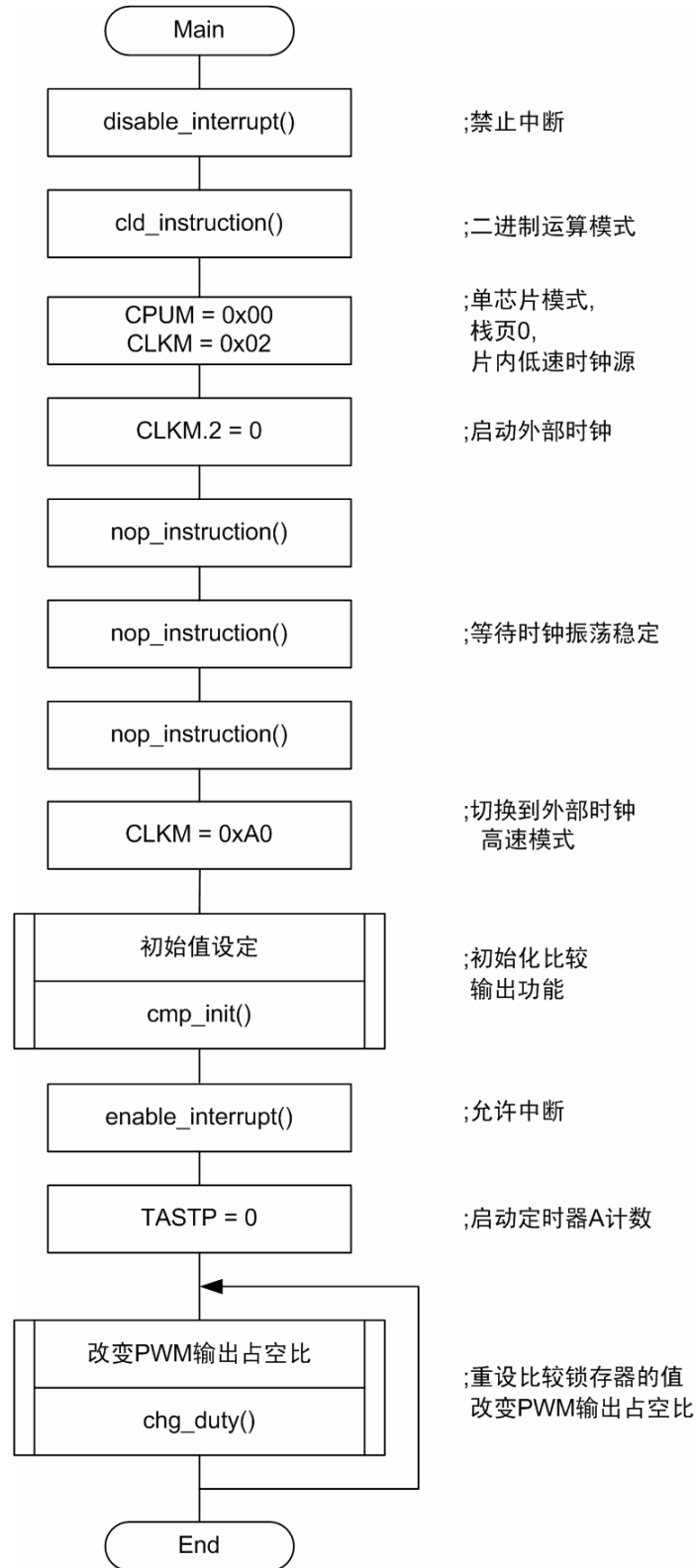

4.2 输出比较初始化子程序 (cmp_init)



4.3 PWM 输出占空比参数设定子程序 (chg_duty)

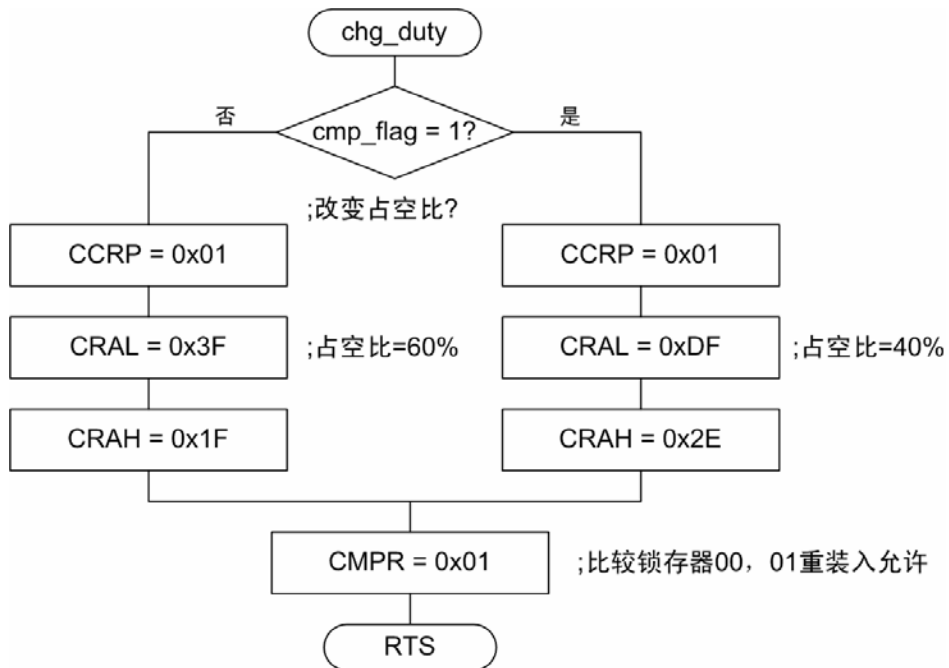

4.4 比较中断服务子程序 (cmp_isr)

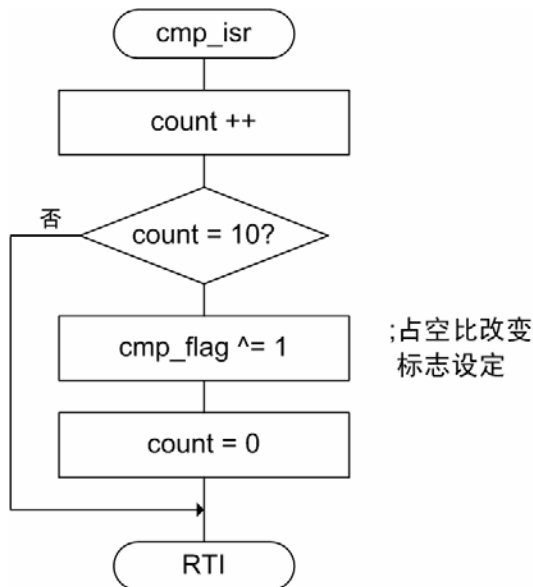

5. 参考例程

请从瑞萨科技网站上下载参考例程。

在 7548/7549 群的网页上单击左边的“Application Notes”下载应用笔记。

6. 参考文献

数据手册

7548 群数据手册

7549 群数据手册

(最新版本请从瑞萨科技网页上取得)

技术信息/技术更新

(最新信息请从瑞萨科技网页上取得)

公司主页和咨询窗口

瑞萨科技公司主页

<http://www.cn.renesas.com>

咨询

<http://www.cn.renesas.com/inquiry>

contact.china@renesas.com

修订记录

Rev.	发行日	修订内容	
		页	要点
1.00	2006.10.23	—	初版发行
2.00	2008.03.07	2	修改 3.3 注
		3	修改 3.4 寄存器设置(1)和(4)的内容
		5	修改 3.4 寄存器设置(13)和注的内容
		9	修改 5 参考例程

Notes regarding these materials

1. This document is provided for reference purposes only so that Renesas customers may select the appropriate Renesas products for their use. Renesas neither makes warranties or representations with respect to the accuracy or completeness of the information contained in this document nor grants any license to any intellectual property rights or any other rights of Renesas or any third party with respect to the information in this document.
2. Renesas shall have no liability for damages or infringement of any intellectual property or other rights arising out of the use of any information in this document, including, but not limited to, product data, diagrams, charts, programs, algorithms, and application circuit examples.
3. You should not use the products or the technology described in this document for the purpose of military applications such as the development of weapons of mass destruction or for the purpose of any other military use. When exporting the products or technology described herein, you should follow the applicable export control laws and regulations, and procedures required by such laws and regulations.
4. All information included in this document such as product data, diagrams, charts, programs, algorithms, and application circuit examples, is current as of the date this document is issued. Such information, however, is subject to change without any prior notice. Before purchasing or using any Renesas products listed in this document, please confirm the latest product information with a Renesas sales office. Also, please pay regular and careful attention to additional and different information to be disclosed by Renesas such as that disclosed through our website. (<http://www.renesas.com>)
5. Renesas has used reasonable care in compiling the information included in this document, but Renesas assumes no liability whatsoever for any damages incurred as a result of errors or omissions in the information included in this document.
6. When using or otherwise relying on the information in this document, you should evaluate the information in light of the total system before deciding about the applicability of such information to the intended application. Renesas makes no representations, warranties or guaranties regarding the suitability of its products for any particular application and specifically disclaims any liability arising out of the application and use of the information in this document or Renesas products.
7. With the exception of products specified by Renesas as suitable for automobile applications, Renesas products are not designed, manufactured or tested for applications or otherwise in systems the failure or malfunction of which may cause a direct threat to human life or create a risk of human injury or which require especially high quality and reliability such as safety systems, or equipment or systems for transportation and traffic, healthcare, combustion control, aerospace and aeronautics, nuclear power, or undersea communication transmission. If you are considering the use of our products for such purposes, please contact a Renesas sales office beforehand. Renesas shall have no liability for damages arising out of the uses set forth above.
8. Notwithstanding the preceding paragraph, you should not use Renesas products for the purposes listed below:
 - (1) artificial life support devices or systems
 - (2) surgical implantations
 - (3) healthcare intervention (e.g., excision, administration of medication, etc.)
 - (4) any other purposes that pose a direct threat to human life

Renesas shall have no liability for damages arising out of the uses set forth in the above and purchasers who elect to use Renesas products in any of the foregoing applications shall indemnify and hold harmless Renesas Technology Corp., its affiliated companies and their officers, directors, and employees against any and all damages arising out of such applications.
9. You should use the products described herein within the range specified by Renesas, especially with respect to the maximum rating, operating supply voltage range, movement power voltage range, heat radiation characteristics, installation and other product characteristics. Renesas shall have no liability for malfunctions or damages arising out of the use of Renesas products beyond such specified ranges.
10. Although Renesas endeavors to improve the quality and reliability of its products, IC products have specific characteristics such as the occurrence of failure at a certain rate and malfunctions under certain use conditions. Please be sure to implement safety measures to guard against the possibility of physical injury, and injury or damage caused by fire in the event of the failure of a Renesas product, such as safety design for hardware and software including but not limited to redundancy, fire control and malfunction prevention, appropriate treatment for aging degradation or any other applicable measures. Among others, since the evaluation of microcomputer software alone is very difficult, please evaluate the safety of the final products or system manufactured by you.
11. In case Renesas products listed in this document are detached from the products to which the Renesas products are attached or affixed, the risk of accident such as swallowing by infants and small children is very high. You should implement safety measures so that Renesas products may not be easily detached from your products. Renesas shall have no liability for damages arising out of such detachment.
12. This document may not be reproduced or duplicated, in any form, in whole or in part, without prior written approval from Renesas.
13. Please contact a Renesas sales office if you have any questions regarding the information contained in this document, Renesas semiconductor products, or if you have any other inquiries.

注意

本文只是参考译文，前页所载英文版“Cautions”具有正式效力。

关于利用本资料时的注意事项

1. 本资料是为了让用户根据用途选择合适的本公司产品的参考资料，对于本资料中所记载的技术信息，并非意味着对本公司或者第三者的知识产权及其他权利做出保证或对实施权力进行的承诺。
2. 对于因使用本资料所记载的产品数据、图、表、程序、算法及其他应用电路例而引起的损害或者对第三者的知识产权及其他权利造成侵犯，本公司不承担任何责任。
3. 不能将本资料所记载的产品和技术用于大规模破坏性武器的开发等目的、军事目的或其他的军需用途方面。另外，在出口时必须遵守日本的《外汇及外国贸易法》及其他出口的相关法令并履行这些法令中规定的必要手续。
4. 本资料所记载的产品数据、图、表、程序、算法以及其他应用电路例等所有信息均为本资料发行时的内容，本公司有可能在未做事先通知的情况下，对本资料所记载的产品或者产品规格进行更改。所以在购买和使用本公司的半导体产品之前，请事先向本公司的营业窗口确认最新的信息并经常留意本公司通过公司主页（<http://www.renesas.com>）等公开的最新信息。
5. 对于本资料中所记载的信息，制作时我们尽力保证出版时的精确性，但不承担因本资料的叙述不当而使顾客遭受损失等的任何相关责任。
6. 在使用本资料所记载的产品数据、图、表等所示的技术内容、程序、算法及其他应用电路例时，不仅要对所使用的技术信息进行单独评价，还要对整个系统进行充分的评价。请顾客自行负责，进行是否适用的判断。本公司对于是否适用不负任何责任。
7. 本资料中所记载的产品并非针对万一出现故障或是错误运行就会威胁到人的生命或给人体带来危害的机器、系统(如各种安全装置或者运输交通用的、医疗、燃烧控制、航天器械、核能、海底中继用的机器和系统等)而设计和制造的,特别是对于品质和可靠性要求极高的机器和系统等(将本公司指定用于汽车方面的产品用于汽车时除外)。如果要用于上述的目的,请务必事先向本公司的营业窗口咨询。另外,对于用于上述目的而造成的损失等,本公司概不负责。
8. 除上述第7项内容外,不能将本资料中记载的产品用于以下用途。如果用于以下用途而造成的损失,本公司概不负责。
 - 1) 生命维持装置。
 - 2) 植埋于人体使用的装置。
 - 3) 用于治疗(切除患部、给药等)的装置。
 - 4) 其他直接影响到人的生命的装置。
9. 在使用本资料所记载的产品时,对于最大额定值、工作电源电压的范围、放热特性、安装条件及其他条件请在本公司规定的保证范围内使用。如果超出了本公司规定的保证范围使用时,对于由此而造成的故障和出现的事故,本公司将不承担任何责任。
10. 本公司一直致力于提高产品的质量和可靠性,但一般来说,半导体产品总会以一定的概率发生故障、或者由于使用条件不同而出现错误运行等。为了避免因本公司的产品发生故障或者错误运行而导致人身事故和火灾或造成社会性的损失,希望客户能自行负责进行冗余设计、采取延烧对策及进行防止错误运行等的安全设计(包括硬件和软件两方面的设计)以及老化处理等,这是作为机器和系统的出厂保证。特别是单片机的软件,由于单独进行验证很困难,所以要求在顾客制造的最终的机器及系统上进行安全检验工作。
11. 如果把本资料所记载的产品从其载体设备上卸下,有可能造成婴儿误吞的危险。顾客在将本公司产品安装到顾客的设备上时,请顾客自行负责将本公司产品设置为不容易剥落的安全设计。如果从顾客的设备上剥落而造成事故时,本公司将不承担任何责任。
12. 在未得到本公司的事先书面认可时,不可将本资料的一部分或者全部转载或者复制。
13. 如果需要了解关于本资料的详细内容,或者有其他关心的问题,请向本公司的营业窗口咨询。

© 2008. Renesas Technology Corp., All rights reserved.