

Renesas RA Family

Injecting and Updating Secure User Keys

Introduction

Cryptography is important because it provides the tools to implement solutions for authenticity, confidentiality, and integrity, which are vital aspects of any security solution. In modern cryptographic systems, the security of the system no longer depends on the secrecy of the algorithm used but rather on the secrecy of the keys.

Renesas MCU security revolves around integrated security engines. There are different types of security engines across the RA MCU. Users can find the specific engine used in a particular MCU from its hardware user's manual.

- The following two types of security engines can operate in two different modes, called Compatibility Mode and Protected Mode. The application note Renesas SCE Operational Modes (R11AN0498) explains the definition of the two modes and their use cases. In Compatibility Mode, the following two security engines can inject secure keys as well as plaintext keys. In Protected Mode, these two security engines can inject only secure keys.
 - The Renesas Secure IP (RSIP) security engine, which is available on RA8 MCUs.
 - The Secure Crypto Engine 9 (SCE9) which is available on some RA6 and RA4 MCUs
- Other available security engines used in RA Family MCUs are Secure Crypto Engine 7 (SCE7), Secure Crypto Engine 5 (SCE5), and Secure Crypto Engine 5_B (SCE5_B). These security engines can only operate in Compatibility Mode and can inject secure keys as well as plaintext keys.

With this release, this application project demonstrates the following secure key injection processes:

- RSIP Compatibility mode AES-128 secure key injection using RA8M1 MCU
- SCE9 Protected Mode AES-256 and ECC secp256r1 public key secure key injection using RA6M4 MCU
- SCE7 Compatibility Mode AES-128 secure key injection using RA6M3 MCU. Compatibility Mode secure key injection for SCE5 and SCE5_B uses APIs identical to those of SCE7 secure key injection.

Example keys are provided with the projects. This application note describes how to modify the projects to use custom keys.

Required Resources

Target Devices:

RA8M1/RA8D1/RA8T1 (with RSIP)

RA6M1/RA6M2/RA6M3 (with SCE7 Compatibility Mode only)

RA6M4/RA6M5/RA4M2/RA4M3 (with SCE9)

RA6T2 (with SCE5_B Compatibility Mode only)

RA4M1/RA4W1 (with SCE5 Compatibility Mode only)

Development tools and software

- e² studio IDE v2024-07
- Renesas Flexible Software Package (FSP) v5.5.0
- SEGGER J-Link® USB driver and RTT Viewer
- Renesas Flash Programmer (RFP) v3.16
- Renesas Security Key Management Tool v1.0.7

The FSP, J-Link USB drivers, and e² studio are bundled in a downloadable platform installer available on the FSP webpage at [renesas.com/ra/fsp](https://www.renesas.com/ra/fsp). SEGGER RTT Viewer is available for download free-of-charge from <https://www.segger.com/products/debug-probes/j-link/tools/rtt-viewer/>. RFP is available for download from <https://www.renesas.com/software-tool/renesas-flash-programmer-programming-gui>. The free-of-charge

edition can be used for the functionality required by this Application Project. The Security Key Management Tool can be downloaded at <https://www.renesas.com/software-tool/security-key-management-tool>.

Hardware

- EK-RA8M1, Evaluation Kit for RA8M1 MCU Group (<http://www.renesas.com/ra/ek-ra8m1>)
- EK-RA6M4, Evaluation Kit for RA6M4 MCU Group (<http://www.renesas.com/ra/ek-ra6m4>)
- EK-RA6M3, Evaluation Kit for RA6M3 MCU Group (<http://www.renesas.com/ra/ek-ra6m3>)
- Workstation running Windows® 10
- One USB device cable (type-A male to micro-B male)

Prerequisites and Intended Audience

This application note assumes you have some experience with the Renesas e² studio IDE and Arm®-TrustZone®-technology based development models with e² studio. In addition, the application note assumes that you have some knowledge of RA Family MCU security features. You can reference the section “Security Features” in the hardware user’s manual for background knowledge preparation for the cryptographic key injection. The intended audience are product developers, product manufacturers, product support, or end users who are involved with any stage of injecting or updating secure keys with Renesas RA Family MCUs.

Contents

1.	Wrapped Key Creates Root of Trust	5
1.1	Introduction to Root of Trust.....	5
1.2	Introduction to Security Engine and Associated Keys.....	5
1.3	Renesas Secure Key Injection Advantages	7
1.3.1	Advantages of Key Wrapping over Key Encryption	7
1.3.2	Advantages of Key Wrapping using MCU HUK	8
1.4	Renesas RA MCU Factory Boot Firmware Limitations for SCE9	8
2.	Wrapped Key Injection Use Cases and Injection Procedure Overview	9
2.1	Wrapped Key Types	9
2.2	General Steps for Secure Key Injection and Update	9
2.2.1	Key Injection	9
2.2.2	Key Update.....	10
2.3	Overview of the Operations for Evaluating the Example Projects	11
2.4	Tools Used in the Secure Key Injection and Update.....	13
3.	Using the Renesas Key Wrap Service	14
3.1	Create PGP Key Pair.....	14
3.2	Registration with DLM Server.....	17
3.3	Exchange User and Renesas PGP Public Keys	19
4.	Wrapping the User Factory Programming Key Using the Renesas Key Wrap Service	23
4.1	Renesas Security Key Management Tool.....	23
4.2	Creating the User Factory Programming Key using the SKMT GUI Interface	24
4.3	Creating the User Factory Programming Key using the CLI Interface	28
4.4	Wrapping the UFPK.....	28
5.	Secure Key Injection for SCE9 Protected Mode	34
5.1	Wrap Keys with the UFPK and W-UFPK.....	34
5.1.1	Using the SKMT GUI Interface.....	34
5.1.2	Using the SKMT CLI Interface.....	43
5.2	Secure Key Injection via MCU Boot Interface	47
5.2.1	Setting up the Hardware.....	47
5.2.2	Inject the Initial User Key and Key-Update Key	48
6.	Secure Key Injection Preparation for RSIP and SCE7 Compatibility Mode.....	51
6.1	Wrap an AES-128 User Key Using the UFPK for RSIP-E51A Compatibility Mode	51
6.2	Wrap an AES-128 User Key Using the UFPK for SCE7	54
7.	Example Project for RA6M4 (SCE9 Protected Mode).....	55
7.1	Example Project Overview	56
7.2	Using the RFP Injected Keys	57

7.2.1	Formatting the Injected Keys.....	57
7.2.2	Verifying the Injected Key and the Updated Key.....	58
7.3	FSP Crypto Module Support for User Key Update.....	59
7.3.1	Save the New Wrapped Key to Data Flash.....	60
7.4	Import and Compile the Example Project.....	61
7.5	Running the Example Project.....	61
8.	Example Project for RA8M1 (RSIP Compatibility Mode)	63
8.1	Overview.....	63
8.2	Using the SKMT-Generated Files	64
8.3	RSIP Compatibility Mode Key Injection APIs	64
8.4	Import and Compile the Example Project.....	64
8.5	Running the Example Project.....	64
9.	Example Project for RA6M3 (SCE7 Compatibility Mode)	65
9.1	Overview.....	65
9.2	Using the SKMT-Generated Files	65
9.3	SCE7 Compatibility Mode Key Injection APIs	66
9.4	Import and Compile the Example Project.....	66
9.5	Running the Example Project.....	66
10.	References	67
11.	Website and Support.....	68
	Revision History.....	69

1. Wrapped Key Creates Root of Trust

1.1 Introduction to Root of Trust

Roots of trust are highly reliable hardware, firmware, and software components that perform specific, critical security functions (<https://csrc.nist.gov/projects/hardware-roots-of-trust>). In an IoT system, a root of trust typically consists of identity and cryptographic keys rooted in the hardware of a device. It establishes a unique, immutable, and unclonable identity to authorize a device to exist in the IoT network.

Secure boot is part of the services provided in the Root of Trust in many security systems. The application is authenticated using public key encryption. The associated keys are part of the Root of Trust in the system. Device Identity, which consists of Device Private Key and Device Certificate, is part of the Root of Trust for many IoT devices.

From the above Root of Trust discussion, we can see that leakage of cryptographic keys can bring the secure system into a risky state. Protection of the Root of Trust involves limiting key accessibility to within the cryptographic boundary only, with keys that are securely stored and preferably unclonable. The Root of Trust should be locked from read and write access by unauthorized parties.

The Renesas user key management system and the MCUs can provide all the above desired protection.

1.2 Introduction to Security Engine and Associated Keys

The security engine (RSIP, SEC9, SEC7, SCE5, or SCE5_B) is an isolated subsystem within the MCU. The security engine contains hardware accelerators for symmetric and asymmetric cryptographic algorithms, as well as various hashes and message authentication codes. It also contains a True Random Number Generator (TRNG), providing an entropy source for cryptographic operations. The security engine is protected by an Access Management Circuit, which can shut down the security engine in the event of an illegal external access attempt. Figure 1 shows the conceptual diagram of the security engine. Refer to Table 1 for exactly what cryptographic operations are supported by each type of security engine.

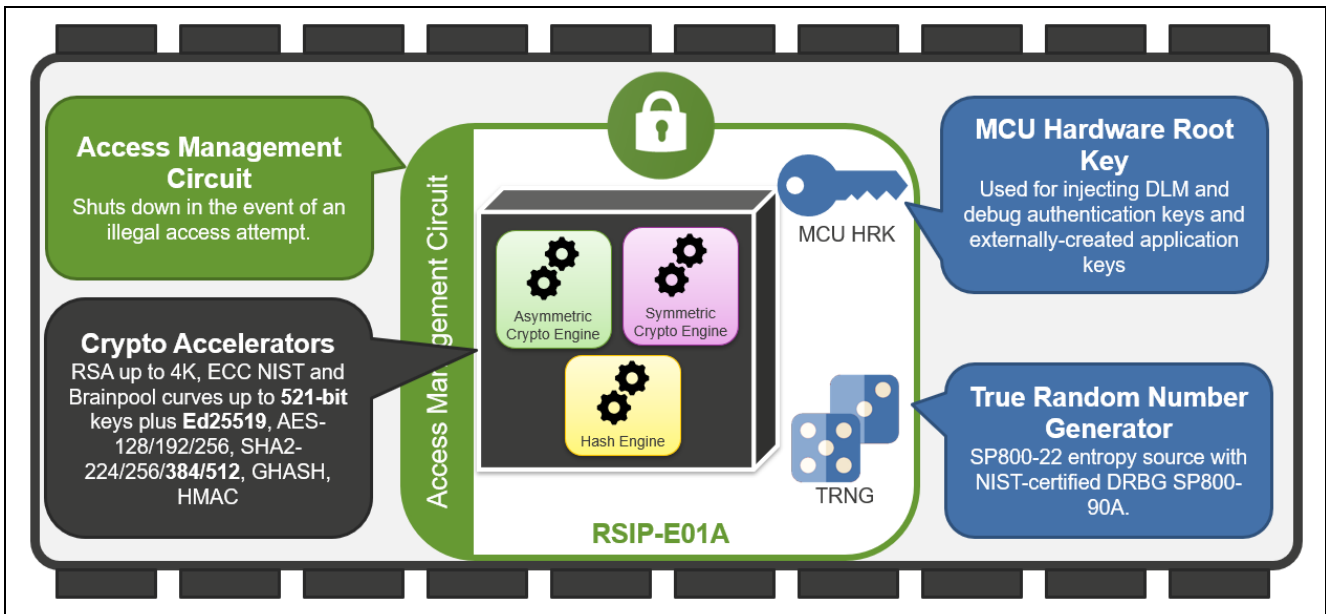

Figure 1. Security Engine Capabilities

The Hardware Root Key (HRK) is not a single key that is physically stored. It is represented in this presentation as such for simplifying the description of the concepts. The security engine contains internal RAM for operations that deal with sensitive material such as plaintext keys. This RAM is not accessible outside the security engine.

The security engine has its own dedicated internal RAM, enabling all crypto operations to be physically isolated within the security engine. This, combined with advanced key handling capability, means that it is possible to implement applications where there is no plaintext key exposure on any CPU-accessible bus.

Secure key storage and usage is accomplished by storing application keys in wrapped format, encrypted by the MCU's Hardware Unique Key and tagged with a Message Authentication Code. Since wrapped keys can

only be unwrapped by the security engine within the specific MCU that wrapped them, the wrapping mechanism provides unclonable secure storage of application keys. The RA Family also provides a secure key injection mechanism to securely provision your devices.

The security engine is packed full of cryptography features that you can leverage in your higher-level solutions, giving you the option to use hardware acceleration to reduce both execution time and power consumption. All the security engines offer AES, TRNG, and secure key storage and usage. The SCE7, SCE9, and RSIP expand this by offering both RSA and ECC for PKI solutions. The full complement of SCE9 Protected Mode crypto algorithms plus a selection of SCE7 crypto algorithms are NIST CAVP certified. Table 1 summarizes the different security engines and their associated cryptographic functionalities.

Table 1. Renesas Secure IP and Security Engine Cryptographic Capabilities

Functions		RA8x1	RA6M4, RA6M5 RA4M2, RA4M3	RA6M1, RA6M2 RA6M3, RA6T1	RA6T2	RA4M1, RA4W1
Cryptographic Isolation						
Security Engines	Security Engine	RSIP-E51A	SCE9	SCE7	SCE5_B	SCE5
Identity & Key Exchange (Asymmetric)						
RSA	Key Gen, Sign/Verify	Up to 4K	Up to 4K	Up to 2K	-	-
	Key Gen, ECDSA, ECDH	Up to 521 bits	Up to 512 bits	Up to 384 bits	-	-
	Ed25519	Y	-	-	-	-
	DSA	Sign/Verify	-	-	Y	-
Privacy (Symmetric)						
AES	ECB, CBC, CTR	128/192/256	128/192/256	128/192/256	128/256	128/256
	GCTR	128/192/256	128/192/256	128/192/256	-	-
	XTS	128/256	128/256	128/256	-	-
	CCM, GCM, CMAC	128/192/256	128/192/256	128/192/256	128/256	128/256
Data Integrity						
Hash	GHASH	Y	Y	Y	-	-
	HMAC	SHA224/256/384/512	SHA224/256	SHA224/256	-	-
	SHA-2 (224/256)	Y	Y	Y	-	-
	SHA-2 (384/512)	Y	-	-	-	-
TRNG	HW Entropy, SP800-22A	Y	Y	Y	Y	Y
Key Handling						
Wrapped	Confidentiality, authenticity	Y	Y	Y	Y	Y
Plaintext	Legacy compatibility	Y	Y	Y	Y	Y

The features of the various Security Engines are as follows:

- SCE5 provides hardware-accelerated symmetric encryption for confidentiality. The updated SCE5_B uses enhanced secure key handling, leveraging an injected MCU-unique HUK.
- SCE7 adds asymmetric encryption and advanced hash functions for integrity and authentication.
- SCE9 expands upon the SCE7 by leveraging an injected MCU-unique HUK for secure key handling and increasing RSA support up to RSA-4K.
- RSIP expands upon the SCE9 by adding advanced cryptographic algorithms like EdDSA and ECC secp521r, SHA384, and SHA512.

The MCU-unique Hardware Unique Key (HUK) is a 256-bit random key for RSIP and SCE9 and a 128-bit random key for SCE5_B, which is injected into the Renesas factory. This key is stored in a wrapped format using an MCU-unique key wrapping mechanism.

The MCU-unique Hardware Key (HUK) for SCE5 and SCE7 is a derived MCU unique key that serves the same purpose as the HUK for SCE9, RSIP, and SCE5_B in terms of user key wrapping. The derived HUK for SCE7 and SCE5 is never stored and is accessible only by the SCE and not by application code.

Since, for all the security engines, the HUK is in a wrapped format unique to the MCU, even if an attacker were able to extract the stored key, another MCU would not be able to use it.

All security engines can inject a Key Update Key (KUK), which can be used to securely update the user keys when a device is deployed in the field. The KUKs are injected during end-product manufacturing via the MCU’s programming interface or using FSP Crypto Driver. To update keys in a device that is deployed in the field, the new key must be wrapped with one of the previously injected KUKs. In addition to replacing keys that have been compromised, many security policies require key rotation or key update (re-keying) on a regular basis. It is recommended to consider injecting multiple KUKs.

1.3 Renesas Secure Key Injection Advantages

Secure key injection and update, combined with the security engine’s support of wrapped keys, address many vulnerabilities associated with using plaintext keys:

- Plaintext keys are never stored in code flash. In the event of a program memory breach, the sensitive key material is protected.
- Plaintext keys are never stored in RAM. In the event of malicious code executing on the system, the sensitive key material is still protected.
- Keys can be securely stored in code flash, data flash, or even copied into external memory, enabling unlimited secure key storage.

In addition, the Renesas key wrapping techniques protect against device cloning, as discussed below.

1.3.1 Advantages of Key Wrapping over Key Encryption

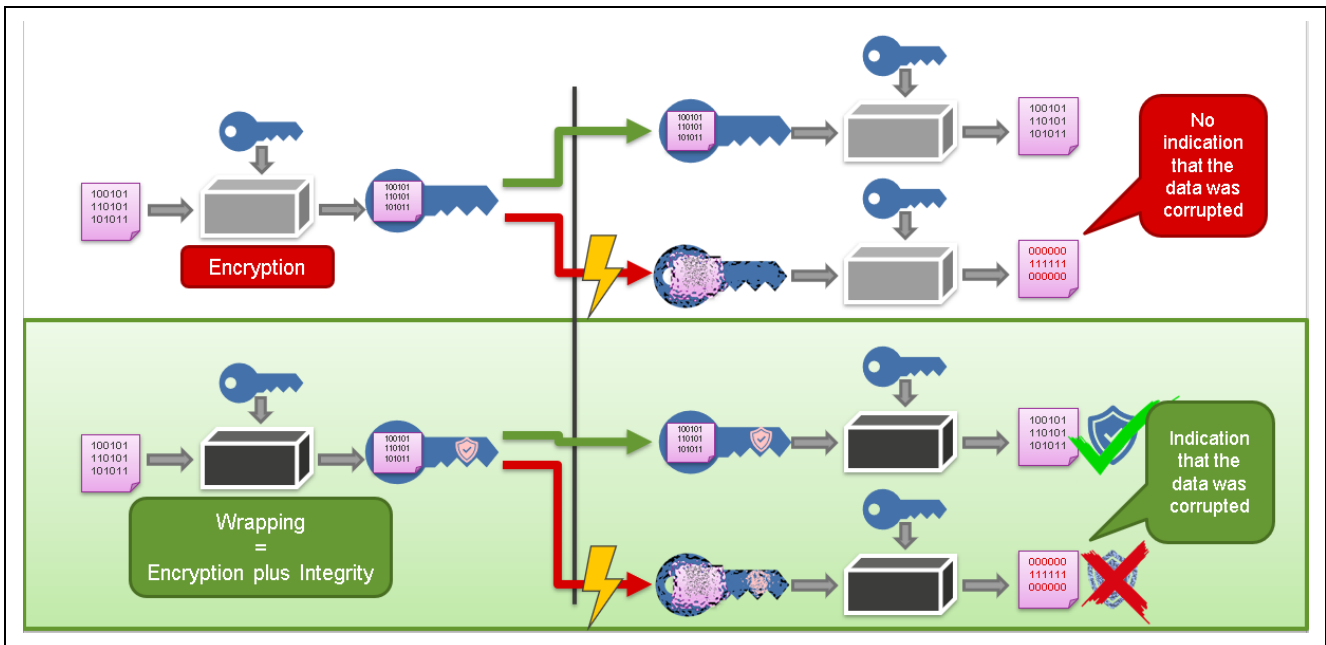

Figure 2. Key Wrapping versus Key Encryption

It is important to understand the difference between wrapping and encrypting for secure asset storage.

When data is encrypted and sent to another recipient, if that recipient has the same key, they can decrypt the data. This results in a confidential exchange of information. However, what if there was a problem with the transmission of the encrypted data? If the recipient unknowingly receives corrupted information, the decryption algorithm will generate garbage data with no indication that the original data has been corrupted.

Wrapping solves this problem by appending a Message Authentication Code to the encrypted output for integrity checking.

1.3.2 Advantages of Key Wrapping using MCU HUK

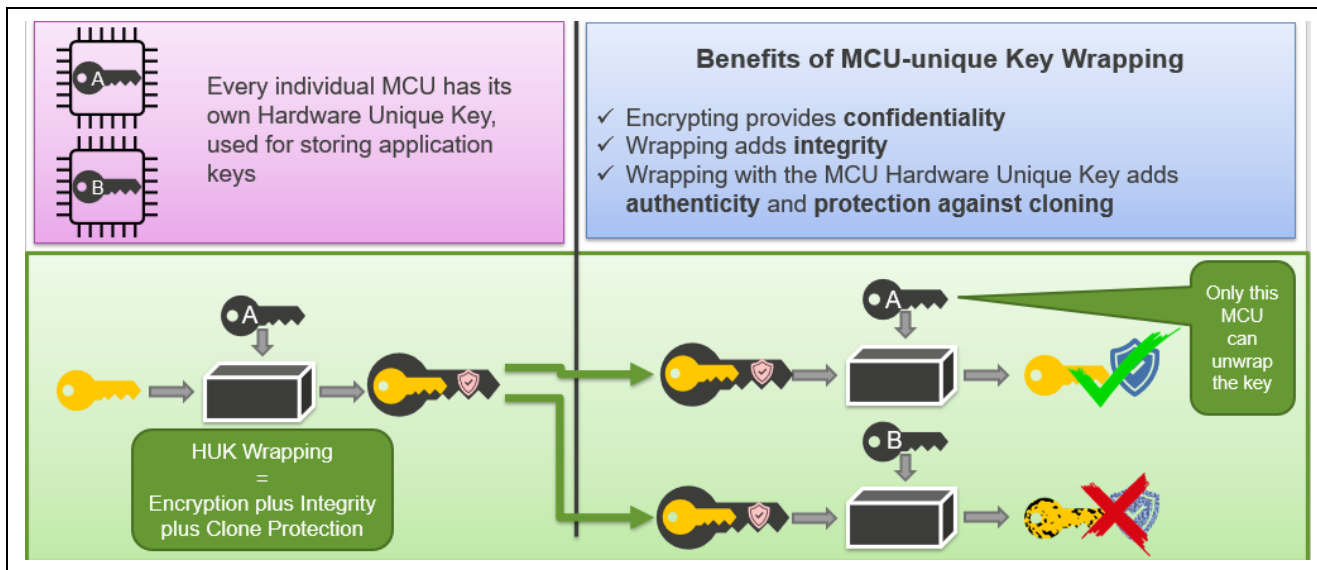

Figure 3. Key Wrapping using the HUK

Using the MCU Hardware Unique Key (HUK) to wrap the stored keys adds another protection feature – clone protection. If the wrapped key is transmitted or copied to another MCU, that MCU’s HUK will not be able to either unwrap or use the copied key. Even if all of the MCU contents are copied onto another device, the keys cannot be used or exposed.

1.4 Renesas RA MCU Factory Boot Firmware Limitations for SCE9

Secure key injection via the serial programming interface is not supported for RSA 3K, RSA 4K, ECC secp256k1, and Key-Update Keys on some older versions of the Renesas RA MCUs due to factory Boot Firmware limitations. The user needs to use a Renesas Flash Programmer (RFP) to read out the Boot Firmware version and confirm the support for the Secure Key Injection of the above-mentioned keys. Refer to the RFP user’s manual Flow of Operations section to access the Bootloader Firmware version by using the **Read Device Information** menu.

- V1.2.04 – WS1: secure user key inject command is not supported
- V1.3.10 – WS2: user key inject command is not supported
- V1.5.22 – CS: user key inject command is supported, but it does not support RSA 3K, RSA 4K, secp256k1, or KUK
- V1.6.25 and above – MP: no limitations

The part information silkscreened on the device can also be checked, though it is recommended that the boot firmware version be confirmed as described above. Boot firmware limitations exist for the following MCUs:

- RA4M2 - All WS and ES devices
- RA4M3 - All WS, ES, and CS devices (date code 014AZ00)
- RA6M4 - All WS, ES, and CS devices (date code 014AZ00). MP device with date codes 028AZ00, 031AZ00
- RA6M5 - All WS and ES devices

Please note that some EK-RA6M4 and EK-RA4M3 Evaluation Kits may contain affected silicon. The following list shows the serial numbers of the affected kit. Note that all early adopter kits with WS or ES silicon are also affected.

- EK-RA4M3 – Serial numbers 219243 – 219542
- EK-RA6M4 – Serial numbers 215938 – 216237 and 218497 - 218996

If your application requires secure key injection of RSA 3K, RSA 4K, ECC secp256k1, or Key-Update Keys and your evaluation kit does not support it, please contact your local Renesas Sales representative.

2. Wrapped Key Injection Use Cases and Injection Procedure Overview

This section provides an overview of the wrapped key injection use cases and the general steps for the injection procedure of each use case. A step-by-step walkthrough of the wrapped key injection procedures is provided in later sections.

2.1 Wrapped Key Types

Table 2 summarizes the key types that can be directly injected into Renesas RA Family MCUs with the RSIP security engine. Injected keys are stored and wrapped by the MCU's HUK.

Table 2. Supported Key Types for RSIP

Lifecycle Transition Keys	SECDBG_KEY, NONSECDBG_KEY, RMA_KEY
AES	AES-128, AES-192, AES-256
RSA	RSA-1024, RSA-2048, RSA-3072, RSA-4096 (Public and Private)
ECC	secp192r1 (NIST P-192), secp224r1 (NIST P-224) (Public and Private) secp256r1 (NIST P-256), secp384r1 (NIST P-384) (Public and Private) secp256k1 (Public and Private) Brainpool P256r1, P384r1, and P512r1 (Public and Private)
HMAC	HMAC-SHA224, HMAC-SHA256
Utility Keys	Key-Update Keys

See Table 1 to understand the types of keys supported for other security engines based on the supported crypto algorithms and Device Lifecycle Management capability.

2.2 General Steps for Secure Key Injection and Update

Secure Key Injection for RSIP, SCE9 Protected Mode, and SCE5_B is performed via the MCU boot interface, demonstrated here with the Renesas Flash Programmer (RFP). Secure Key Injection for RSIP, SCE9 Compatibility Mode, SCE7, and SCE5 compatibility mode is performed through the FSP. Key preparation steps where key material is exposed in plaintext must be performed in a secure environment.

2.2.1 Key Injection

There are three high-level steps for key injection. Section 3 guides the user in establishing the PGP encrypted communication channel between the user and the Renesas DLM Server. Sections 4, 5, and 5.2 provides step-by-step walkthroughs of how to perform the three high-level steps for the secure key injection.

1. The first step in the secure key injection process is to use the Renesas Device Lifecycle Management (DLM) service to wrap an arbitrary User Factory Programming Key (UFPK) (in green) using the Renesas Hardware Root Key (HRK) (in blue). The UFPK is a 256-bit value selected by the user. The same UFPK can be used to inject any number of keys.

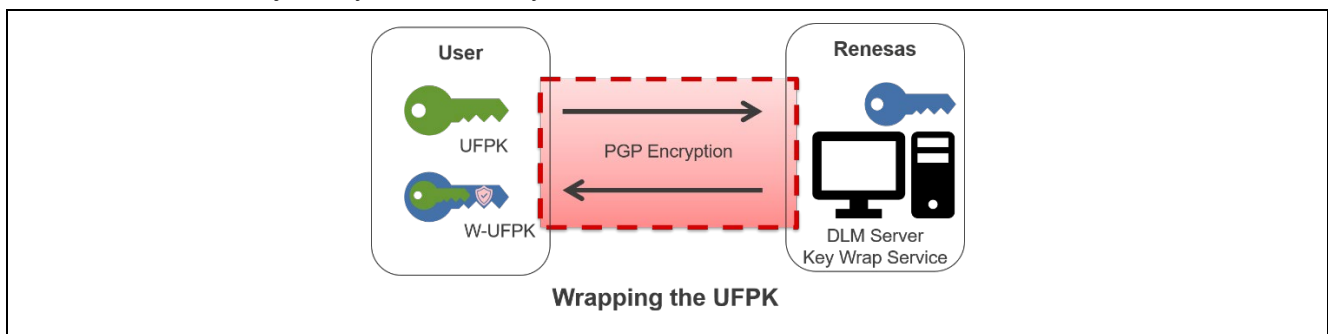

Figure 4. Wrapping the UFPK using DLM Server

2. Next, the user key (in yellow) must be wrapped with the UFPK.

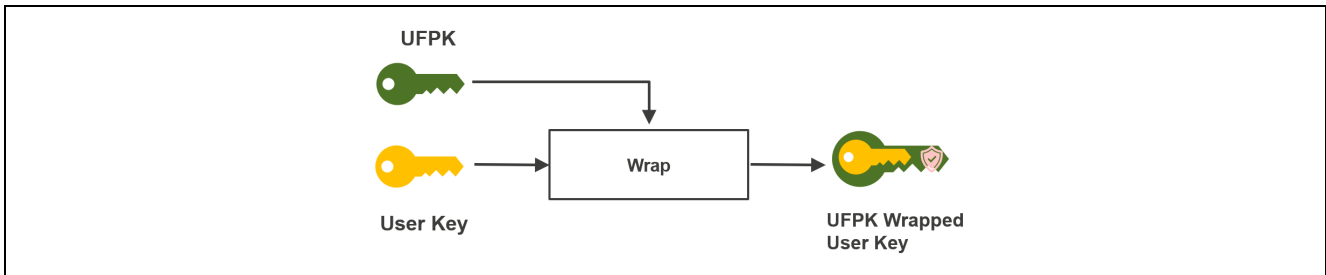

Figure 5. Wrap the User Key with the UFPK

3. Finally, the user key is injected by providing the wrapped UFPK (W-UFPK) and the wrapped user key to the secure key injection mechanism of the security engine. Note that this is a conceptual representation of the secure user key injection. Once the wrapped user key is generated, the tool generates one secure key injection file, which includes the wrapped user key and the W-UFPK. This file (.rkey file) will be used in the secure key injection project.

For the protected mode, injecting the wrapped user key should be performed using the MCU boot interface. For compatibility mode, injecting the wrapped user key should be performed using the FSP key injection PSA Crypto API.

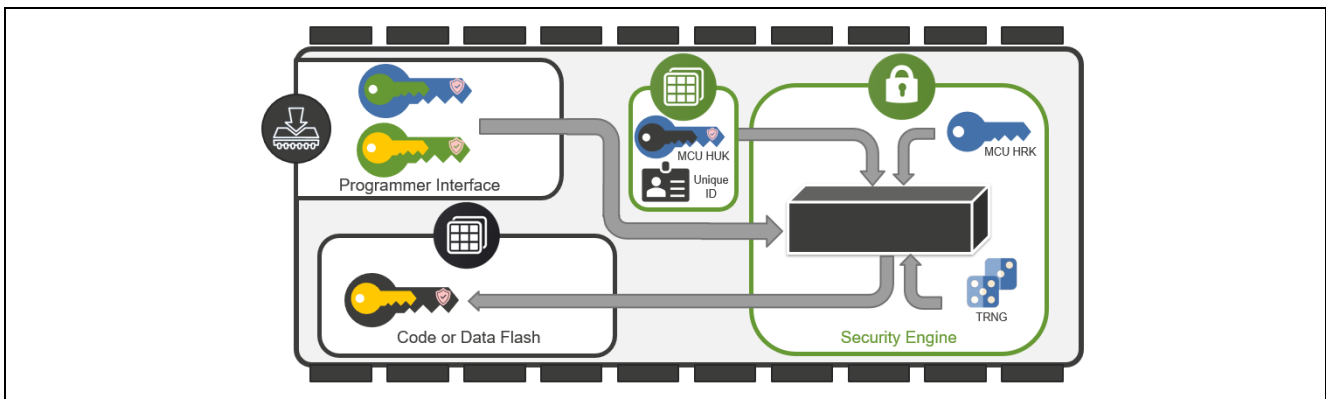

Figure 6. Inject User Key over the Serial Programming Interface

2.2.2 Key Update

Since injecting new keys in the field is usually done to replace older keys (key rotation or re-keying), this process is referred to as a “key update”. To enable secure key updates in the field, one or more Key-Update Keys (KUK) must be injected during production programming/provisioning, as described above.

KUKs, like other cryptographic keys, can be stored in either code flash or data flash (if available on the MCU). Injection of the KUK uses the same procedure as injecting other user keys, as described in the section 2.2.1. Since the KUK is the only mechanism by which new keys can be injected/wrapped, it is highly recommended that multiple KUKs be injected during production provisioning. This enables the KUK to be rotated or revoked to adhere to an infrastructure security policy or to respond to a key exposure security breach.

For MCUs that support secure key injection over the MCU boot interface, additional KUKs CANNOT be injected after the programming interface is disabled. Once a product is in the field with its programming interface disabled, new keys can ONLY be injected via a pre-existing KUK.

The KUKs may be stored in any code or data flash location during production. This location will be passed to the key update API for the injection of the new user key. A user can inject multiple KUKs and provide a scheme to rotate the keys based on a timed schedule or key leakage event. For security reasons, we recommend that users disable the programming interface prior to deploying to the field.

There are two high-level steps for key updates. Note that the KUK must already reside in the MCU.

1. Use the KUK (in grey) to wrap the new user key (in yellow).

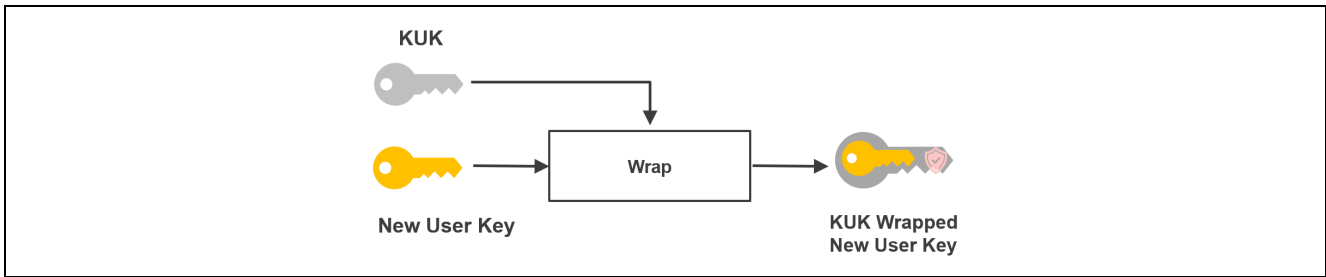

Figure 7. Wrap the New User Key with a KUK

2. Use the FSP and the previously injected KUK to inject the new user key. The new user key is wrapped by the MCU HUK (in black). Note that the APIs for the two modes are provided by different FSP modules.

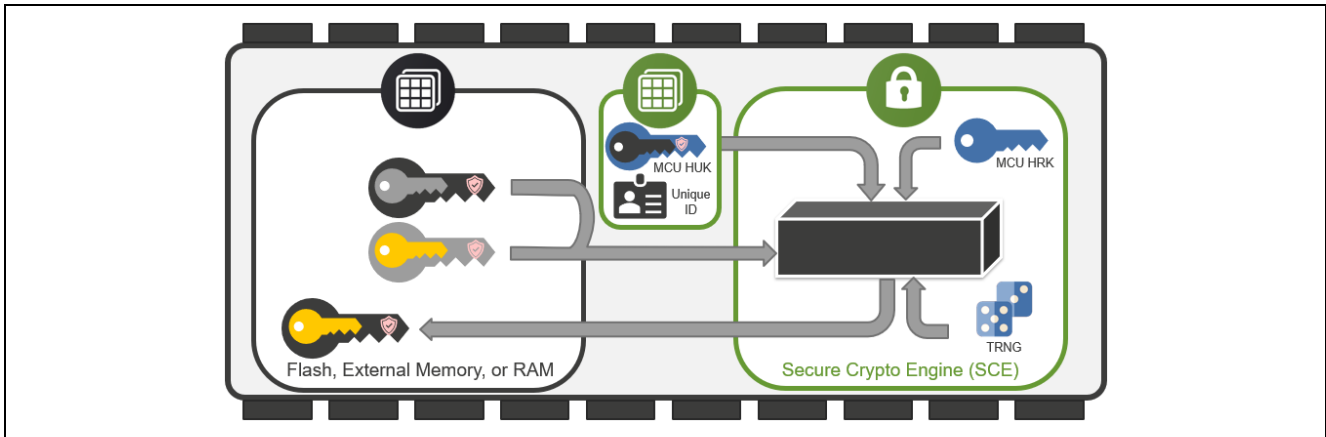

Figure 8. Update the User Key

2.3 Overview of the Operations for Evaluating the Example Projects

The example projects in this application project demonstrate the secure key injection and update capabilities of Renesas RA Family MCUs using sample keys. Sections 3, 4, and 5 describe the steps needed to replace these sample keys with custom keys.

The following graphic shows the flow of this preparation work, plus the example project for SCE9 (RA6M4 example). The block outlined in red is the scope of the functionality of the example project.

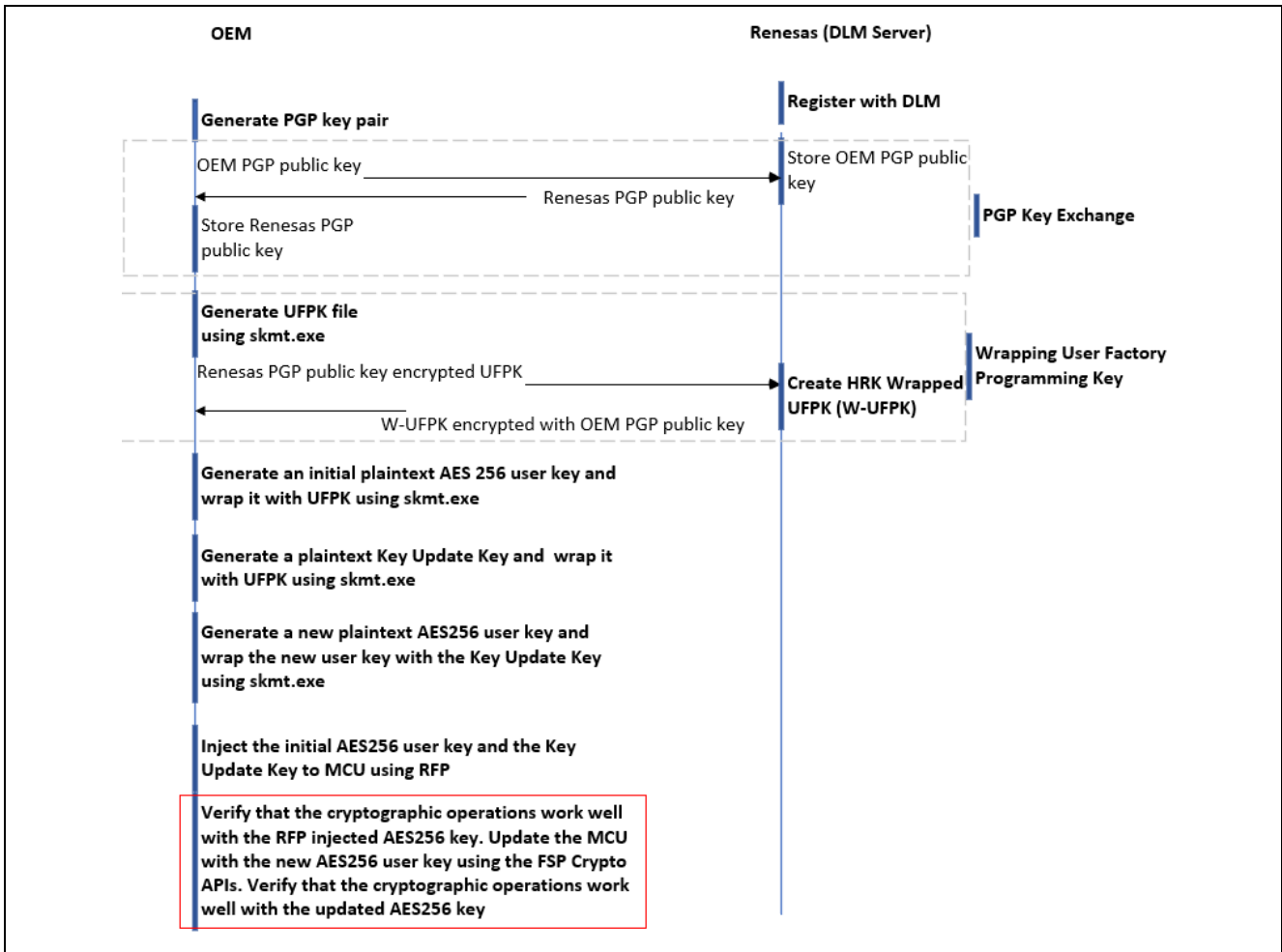

Figure 9. Operational Flow Injecting and Updating an AES-256 Key for SCE9 Protected Mode

The following graphic shows the flow of this preparation work plus the example project for SCE7 (RA6M3 example). The block outlined in red is the scope of the functionality of the example project.

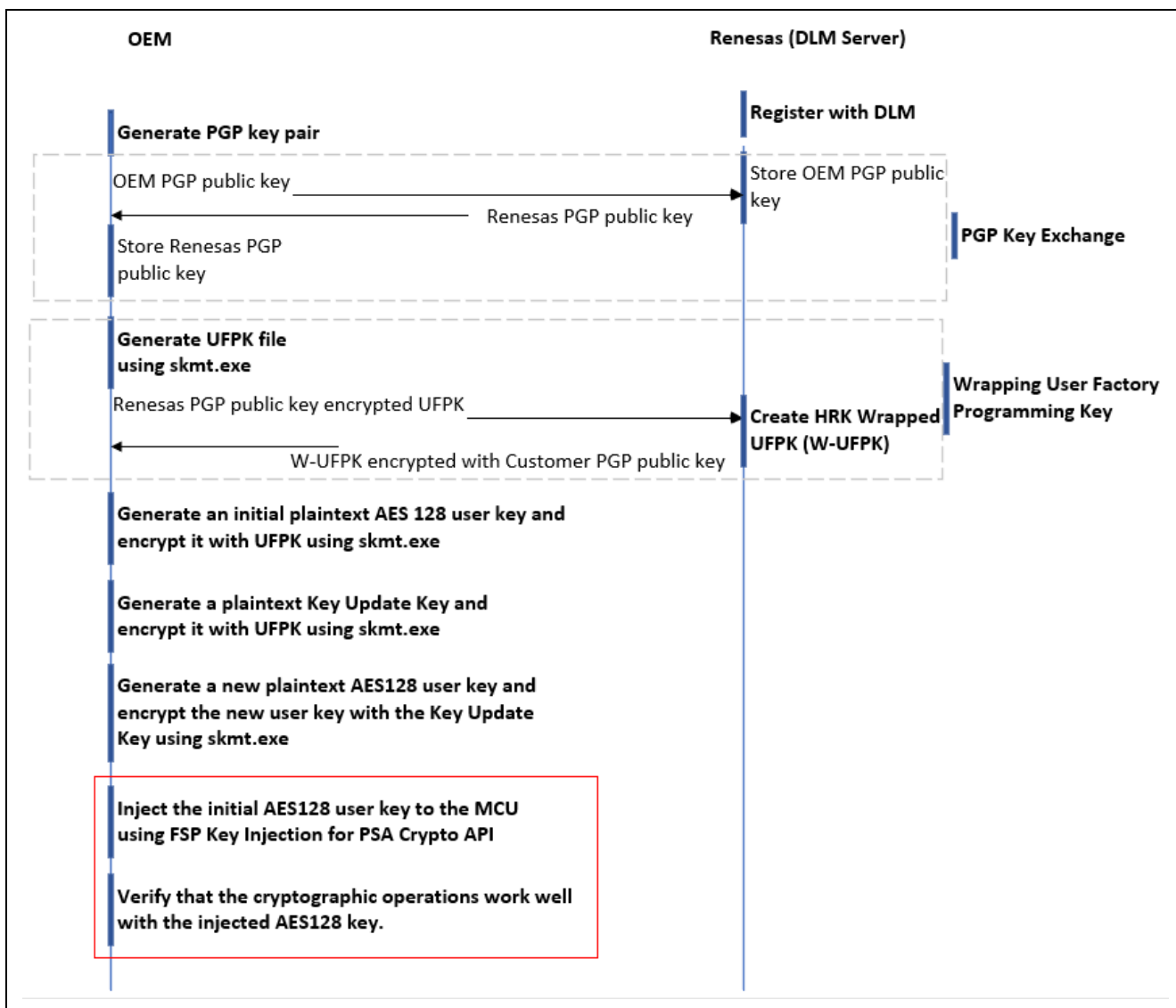

Figure 10. Operational Flow Injecting User Keys for SCE7 and RSIP-E51A Compatibility Mode

2.4 Tools Used in the Secure Key Injection and Update

There are three tools used in the secure key injection and update besides e² studio, which is used as the software project development environment. Refer to the corresponding section mentioned below for details on obtaining, setting up, and using these tools.

- Gpg4win**
 This tool is used in section 3 to establish a PGP encrypted communication channel between user and the Renesas Key Wrap server. Using this tool, the user can generate a user PGP key pair, perform key exchange with the Renesas DLM server, and assist the reception of the W-UFPK.
- Renesas Security Key Management Tool (SKMT)**
 This tool is used in section 4, section 5 and section 6 to generate the following three key files:
 - User key: to be injected to MCU via RFP or FSP API
 - Key update key: to be injected to MCU via RFP
 - New user key wrapped using the KUK: to be updated by an FSP API
- Renesas Flash Programmer (RFP)**
 This tool is used in section 5.2 to inject the User key and KUK when using the security engine Protected Mode.

3. Using the Renesas Key Wrap Service

The Renesas Key Wrap Service must be used to obtain a wrapped UFPK (W-UFPK) for the specific MCU Group and security engine operational mode. All key material exchange is performed with PGP encryption. This section explains the steps to establish this PGP-encrypted communication channel between the user and the Renesas Key Wrap Server. This is a one-time process and does not need to be repeated for different MCUs.

3.1 Create PGP Key Pair

If you already have a PGP key pair, that key can be used for the key exchange process. Otherwise, the instructions below describe one method for creating a PGP key pair.

The PGP software demonstrated here is GPG4Win, which can be downloaded from this URL: <http://www.gpg4win.org/>

The screenshots included in this application note are based on `gpg4win-4.0.0.exe`. There may be minor graphic interface updates with later versions. However, the functionality used in this application note should persist.

Download and install Kleopatra:

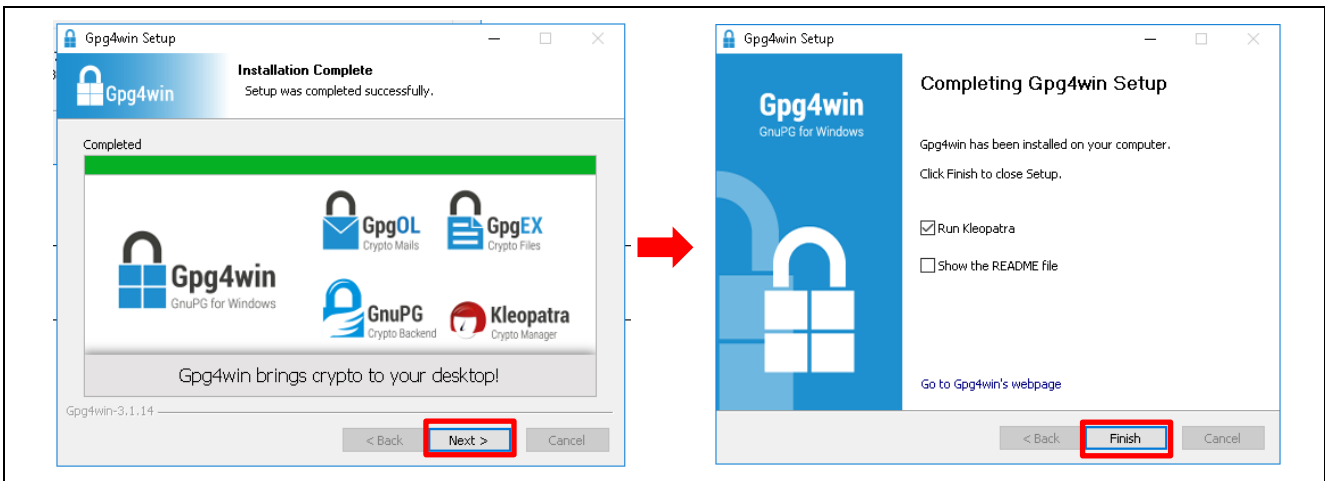

Figure 11. Download and Install Kleopatra

Launch Kleopatra and create a PGP Key Pair.

1. Click **File > New Key Pair**
2. Choose **Create a personal OpenPGP key pair**.

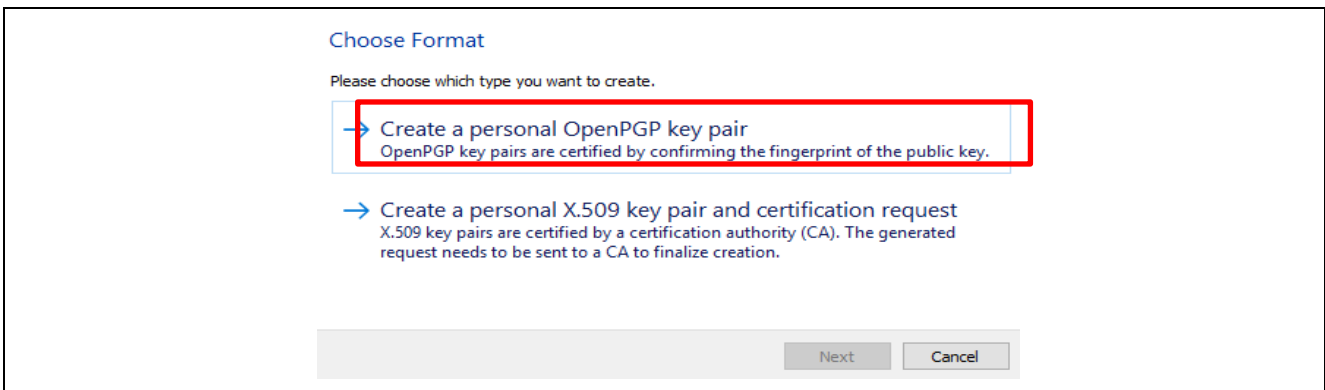

Figure 12. Create a Personal Open PGP Key Pair

3. Provide a **Name** and **Email**. Note that even though these are marked as optional, at least one entity must be provided to move to the next stage. Check **Protect the generated key with a passphrase**.

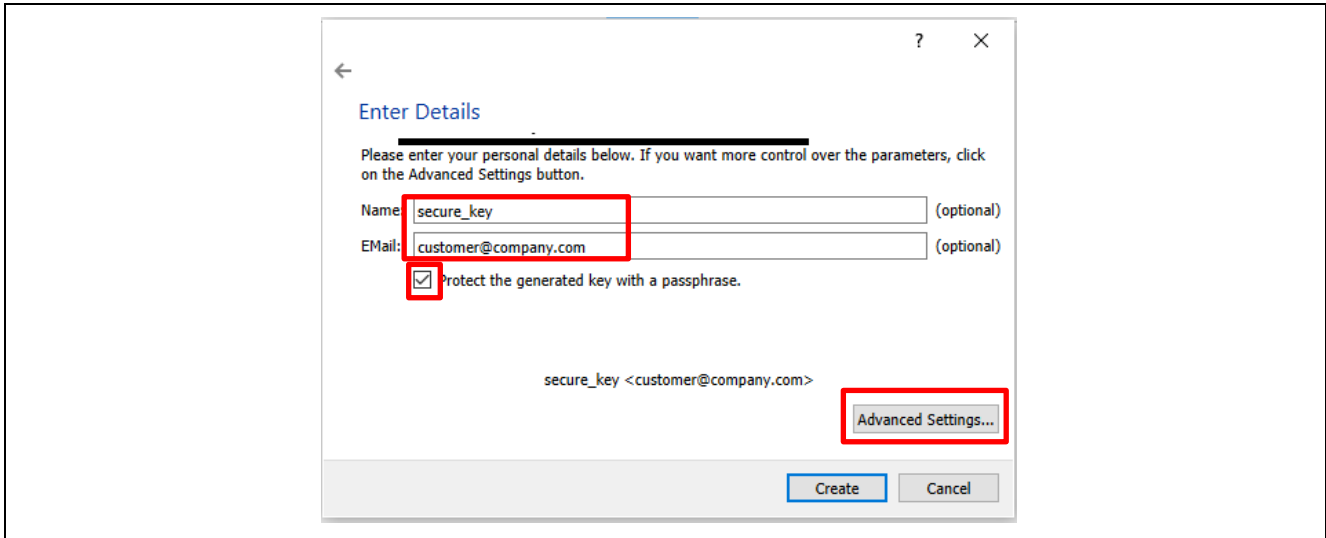

Figure 13. Provide Name and Email

4. Click **Advanced Settings** and select **RSA** as the key type.

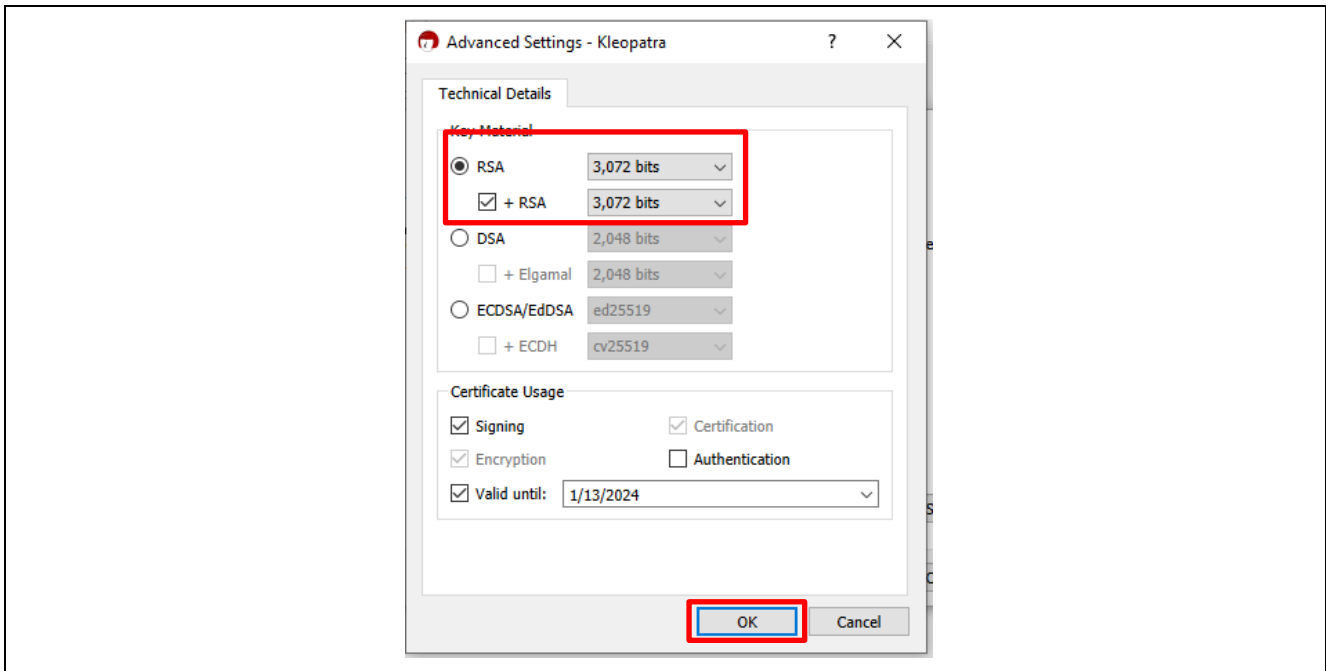

Figure 14. Select RSA Encryption

- Click **Create** and provide a passphrase twice to protect the private key. Then click **OK**. **Be sure to save your passphrase.**

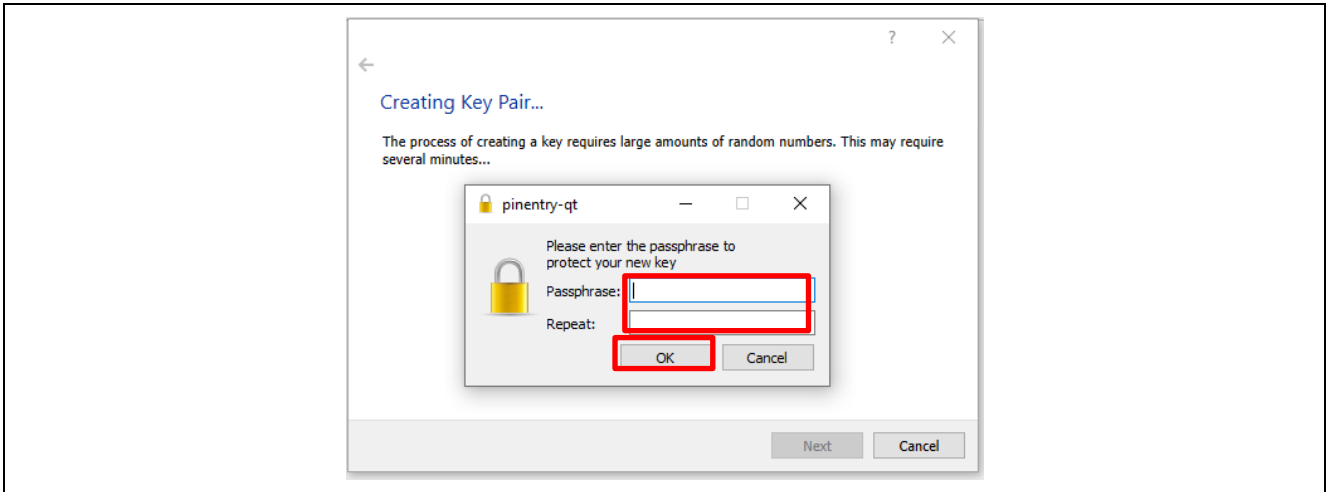

Figure 15. Define a Passphrase

- The PGP key pair should be created successfully. Click **Finish**.

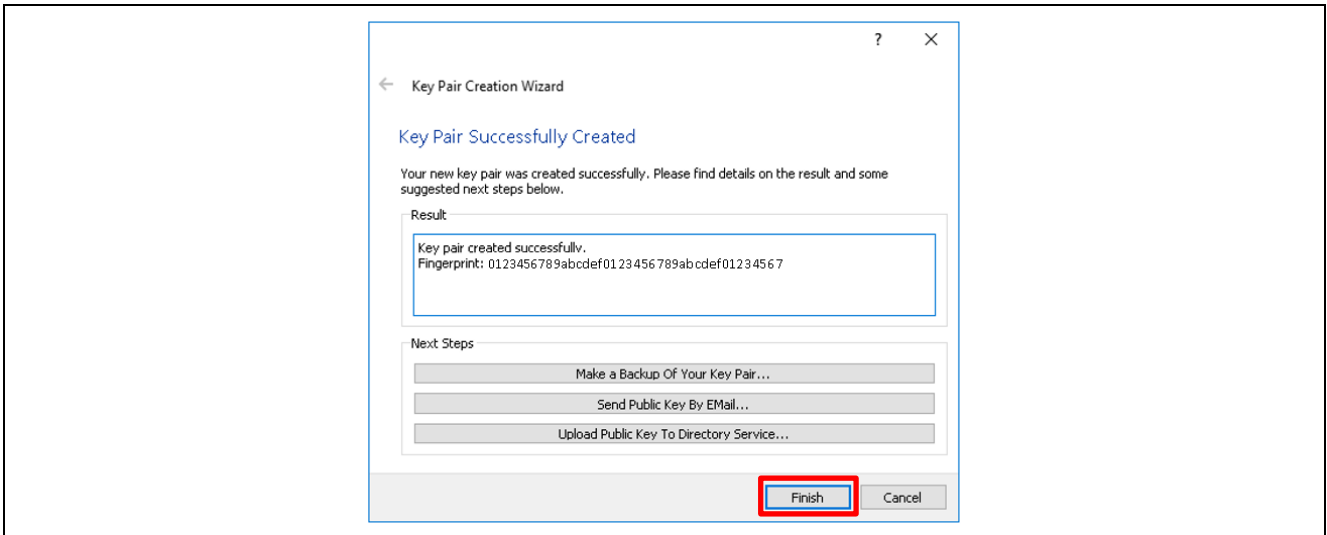

Figure 16. PGP Key Pair Created

- A new item will be created in Kleopatra. Right-click on the keypair just created and select **Export**.

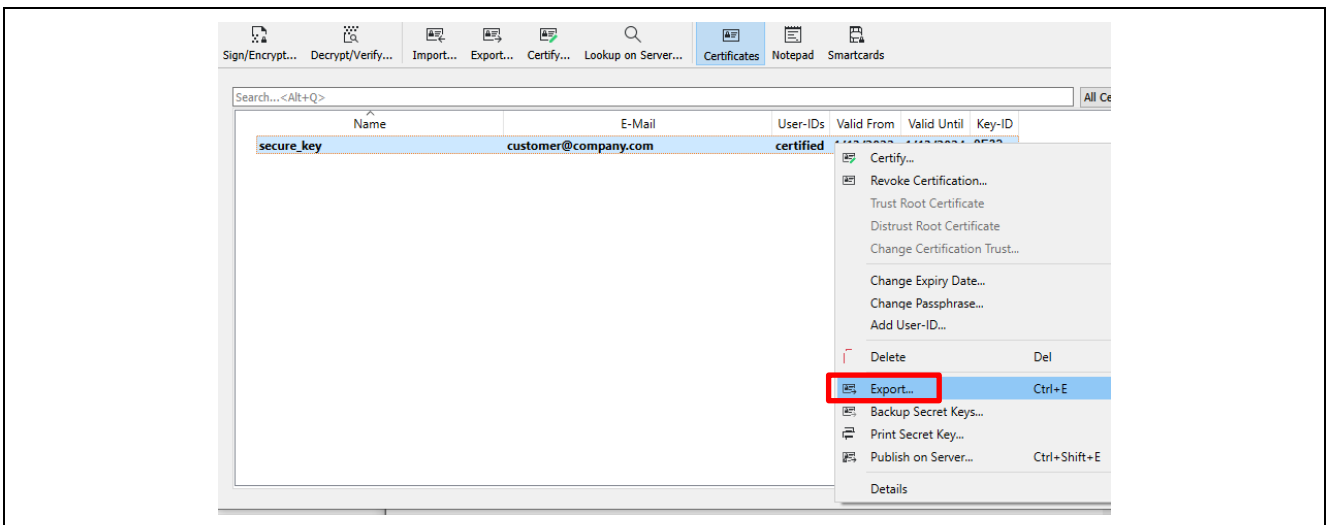

Figure 17. Export the User PGP Public Key

- Save the public key to a file with an *.asc extension. In this example, this file is renamed to customer_public.asc. Click **Save**.

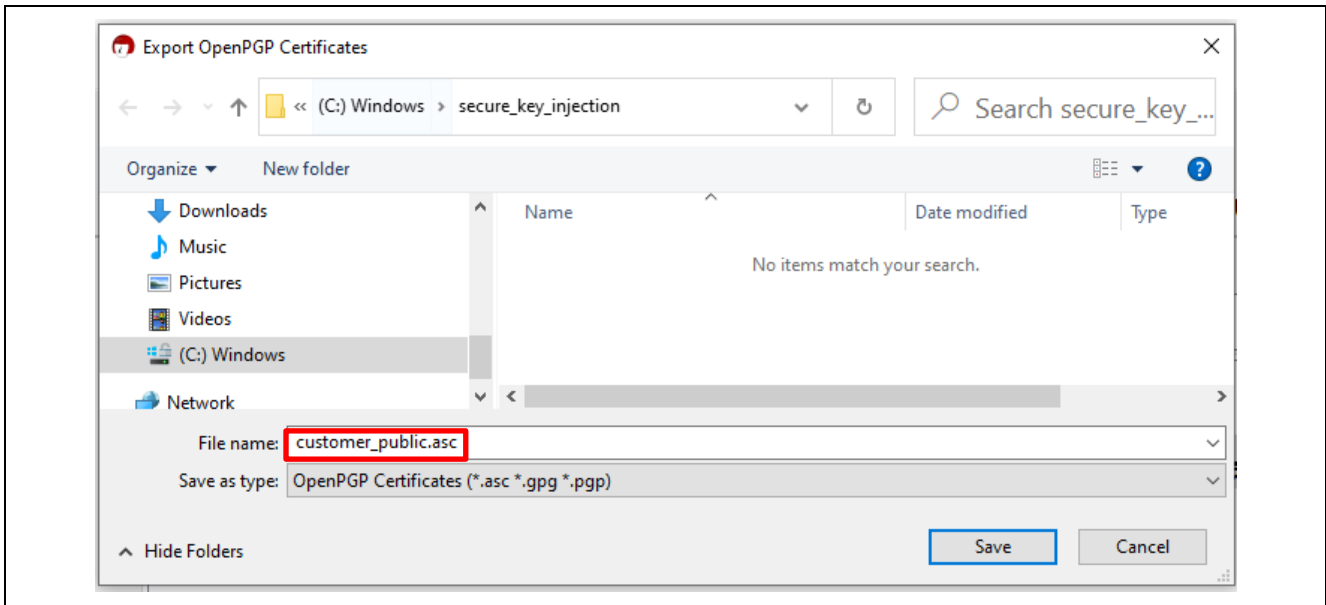

Figure 18. Save the PGP Public Key to a Folder

3.2 Registration with DLM Server

The first time you use the Renesas Key Wrap service, you will have to register with the Renesas DLM Server.

- Open the URL <https://dlm.renesas.com/keywrap> in a browser and click **New registration**.

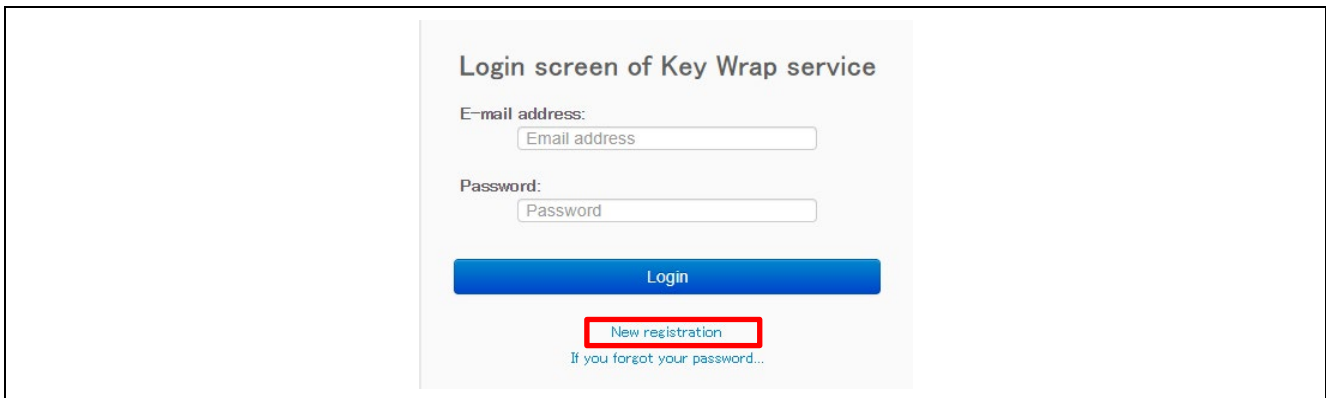

Figure 19. Start Registration with Renesas DLM Server

- Follow the prompt to provide a **valid** email address and click **Send mail**.

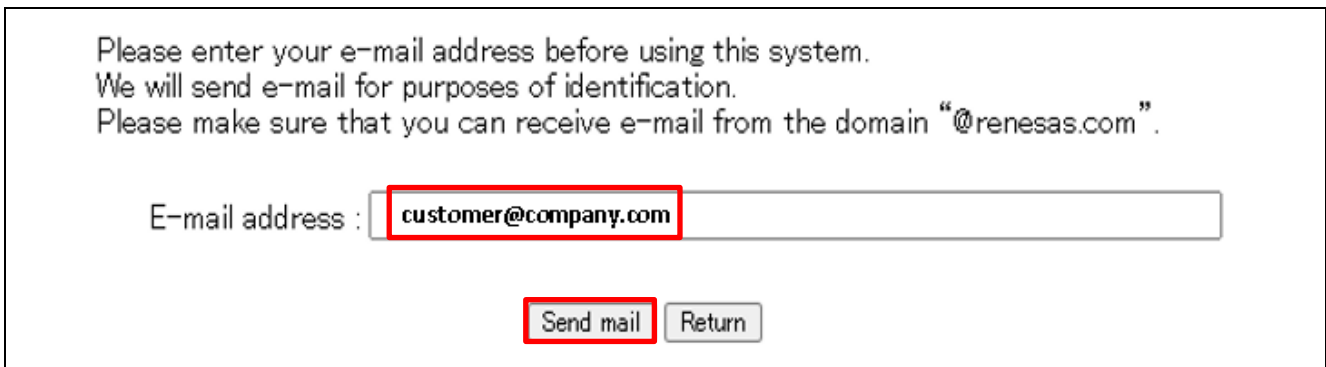

Figure 20. Register User Email Address

After clicking **Send mail**, the following screen will appear. Click **Return**.

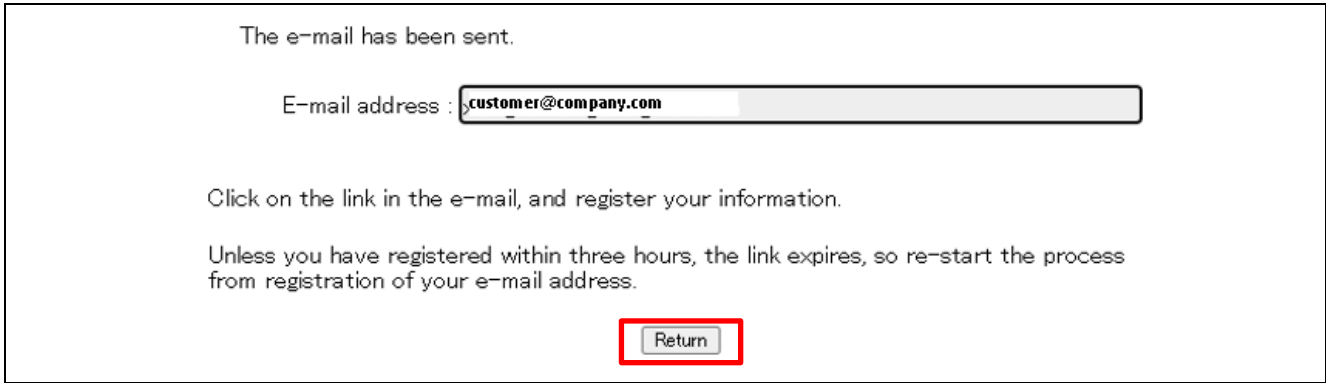

Figure 21. Acknowledge Email Transmission

3. You should receive an email similar to the one shown below. Click on the URL provided to confirm your registration.

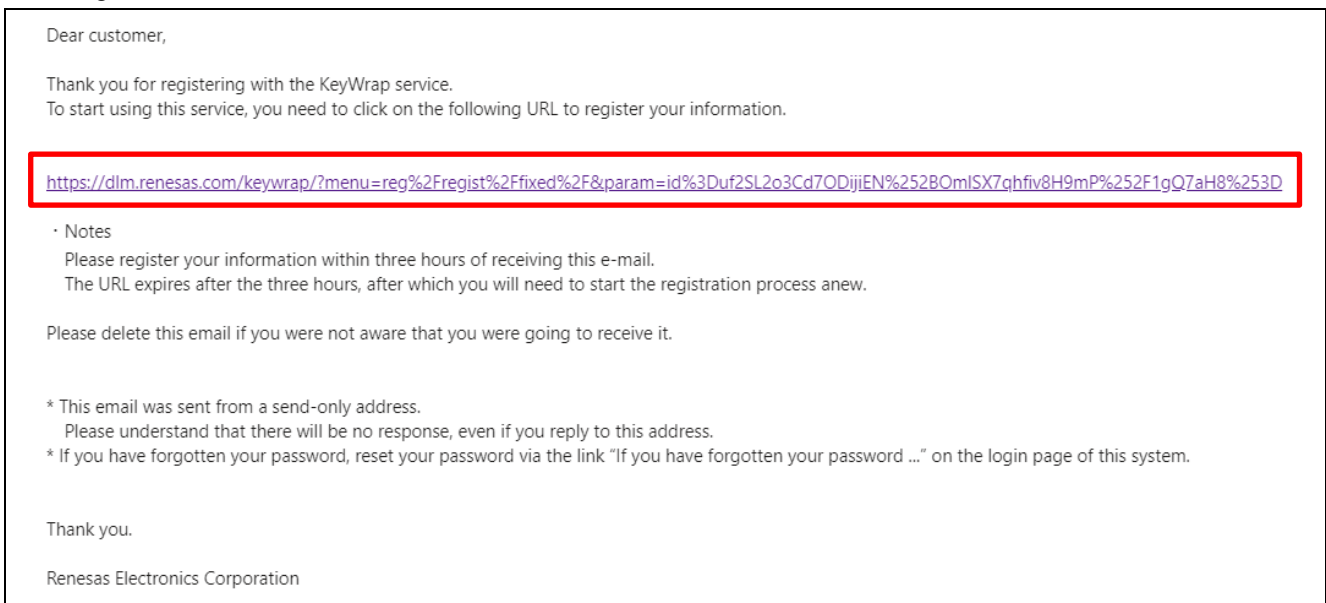

Figure 22. Registration Confirmation Email

4. Follow the prompts to provide your name and company name and create a password. Click the **Next (confirmation)** button. Note that the password must consist of 8 to 32 alphanumeric characters and may include the symbols “!” and “@”.

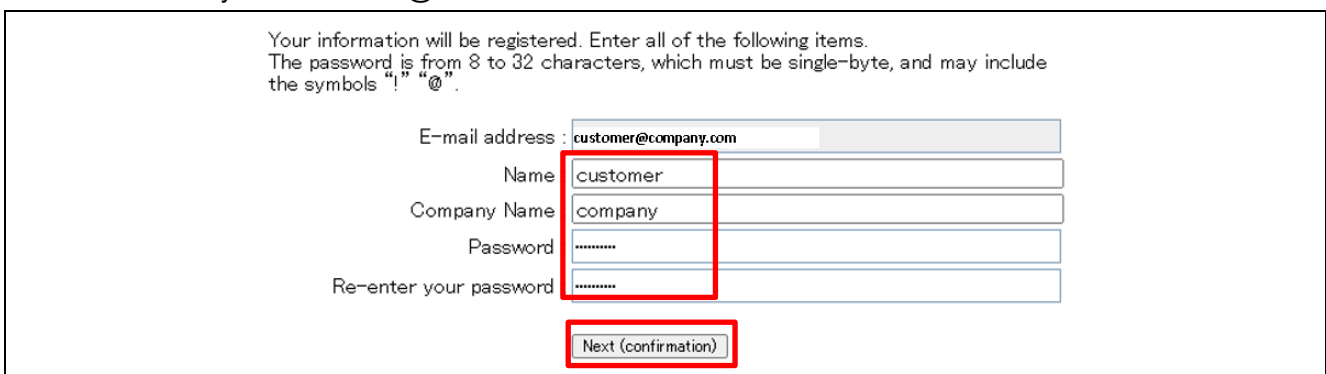

Figure 23. Confirm Registration

After the confirmation screen is displayed, click on the **Register** button to complete the user registration.

The following items will be registered. Are you sure?

E-mail address :

Name :

Company Name :

Password :

Re-enter your password :

Figure 24. Finish the Registration

3.3 Exchange User and Renesas PGP Public Keys

If you have not already exchanged PGP keys with the Renesas DLM server, follow the steps below.

1. After successfully registering the user information, the following screen will open. Click the **Start service** button to start using the key encryption system.

Registered

E-mail address :

Name :

Company Name :

Figure 25. Start DLM Key Wrapping Service

2. When the agreement warning shows up, scroll down to the bottom of the **Trusted Secure IP Key Wrap Agreement** and click **I agree**. You will then be logged into the DLM server. Note that the Agreement will come up every time you log into the DLM server.

--- CAUTION!! ---

--- PLEASE READ THE FOLLOWING BEFORE USING THE SERVICE ---

This Trusted Secure IP Key Wrap Service Agreement (this "Agreement") is between you and Renesas Electronics Corporation. Please carefully note that this Agreement is legally valid agreement relating to Trusted Secure IP key encryption (the "Service").

Article 15 (ENTIRE AGREEMENT)

This Agreement sets forth the entire agreement of the parties with respect to the subject matter hereof and supersedes any prior or contemporaneous agreements, written or oral, concerning the subject matter hereof. Any change, modification or amendment of the terms of this Agreement shall not be effective unless reduced to writing and authorized by both parties.

[View PDF](#)

Figure 26. Agreement for Using the Renesas DLM Server

3. When you log into the DLM system, the window below appears. Click **PGP key exchange**.

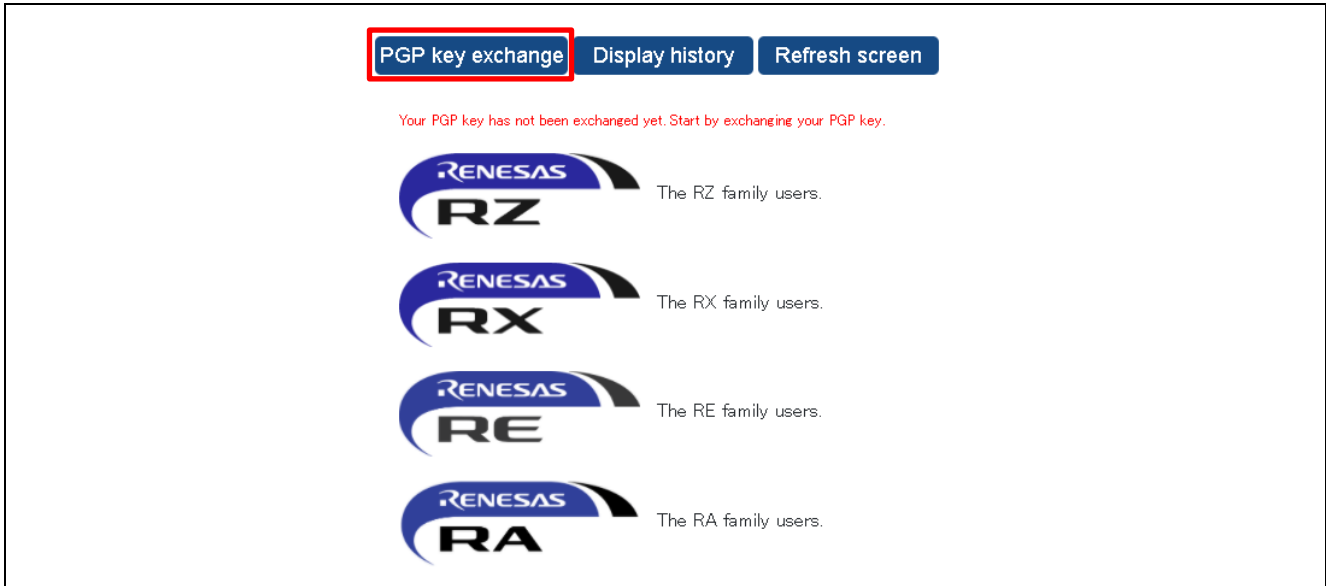

Figure 27. Start PGP Key Exchange

4. Click **Reference** and select the public key generated earlier (`customer_public.asc`). Notice that the fingerprint of the Renesas PGP public key is displayed. This will be used to certify the Renesas public key after you receive it.

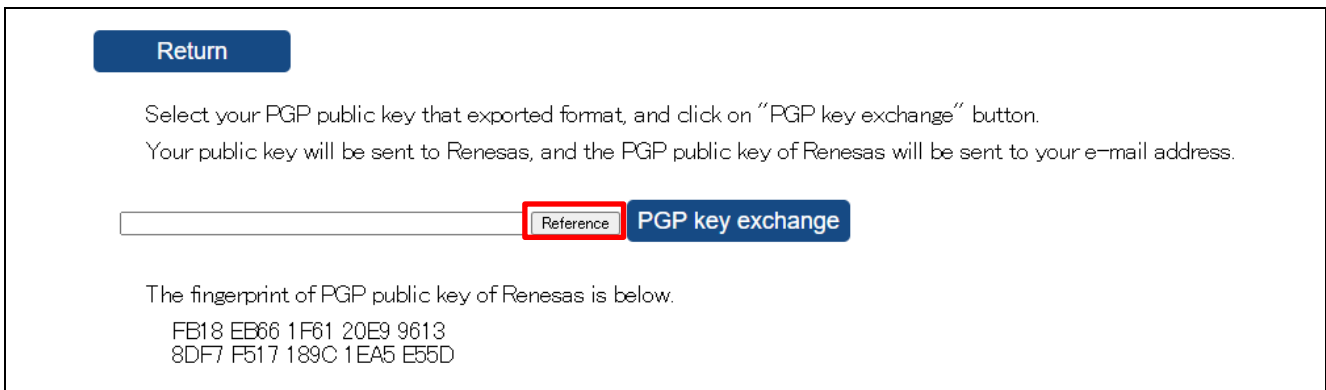

Figure 28. Browse the Customer PGP Public Key

5. Click the **PGP key exchange**.

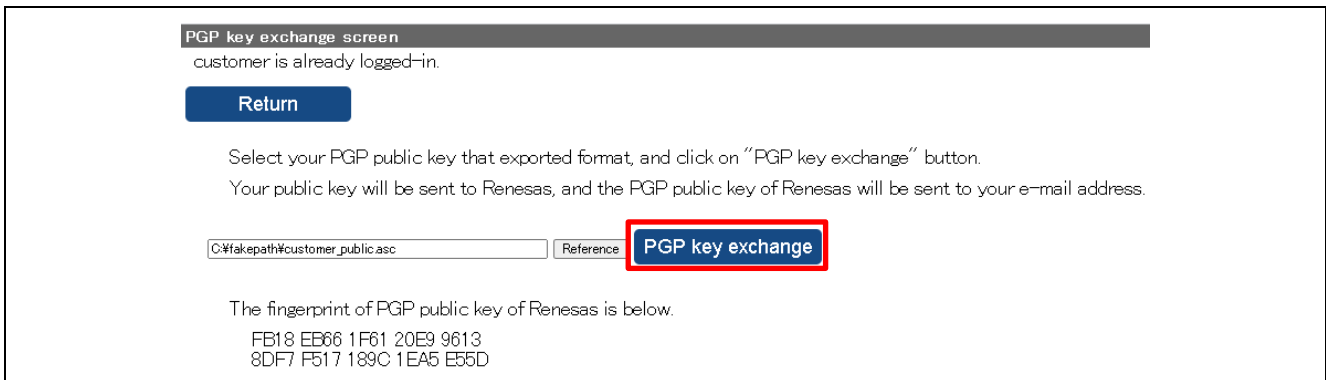

Figure 29. Exchange Keys

6. Once the PGP public key is submitted, click **Return**.

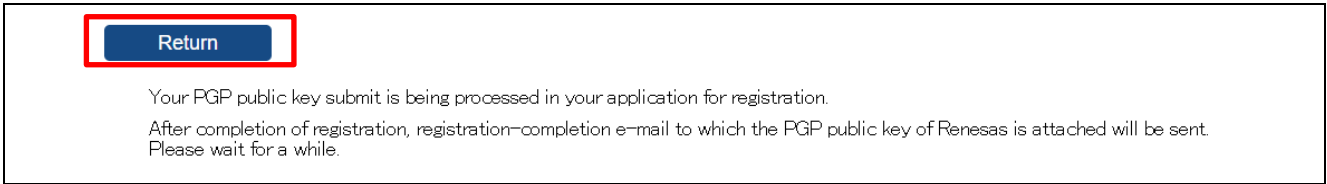

Figure 30. Wait for Renesas’s PGP Public Key

7. You will receive an email from Renesas at the email address registered with the DLM server with the contents as shown below if the key exchange is successful. It typically takes about one to two minutes to receive this email.

Note that a PGP public key can be registered any number of times. The latest PGP public key that has been registered successfully is used for encryption. All previously registered PGP public keys are discarded.

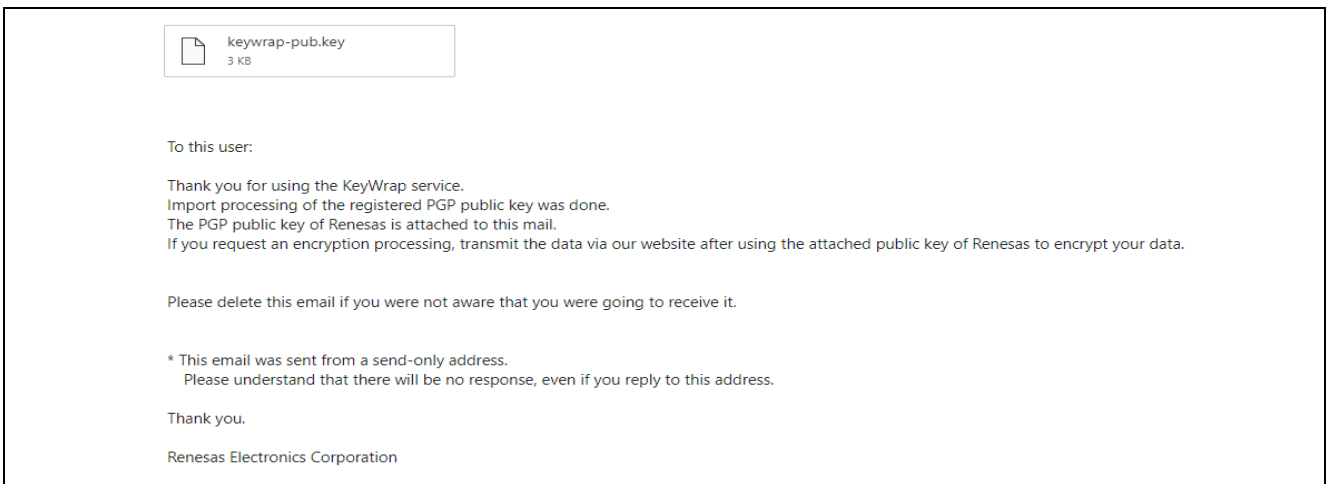

Figure 31. Receive the Renesas PGP Public Key

Save the Renesas PGP public key file (keywrap-pub.key).

8. Go back to the Kleopatra application and import the Renesas PGP Public key to Kleopatra as shown below.

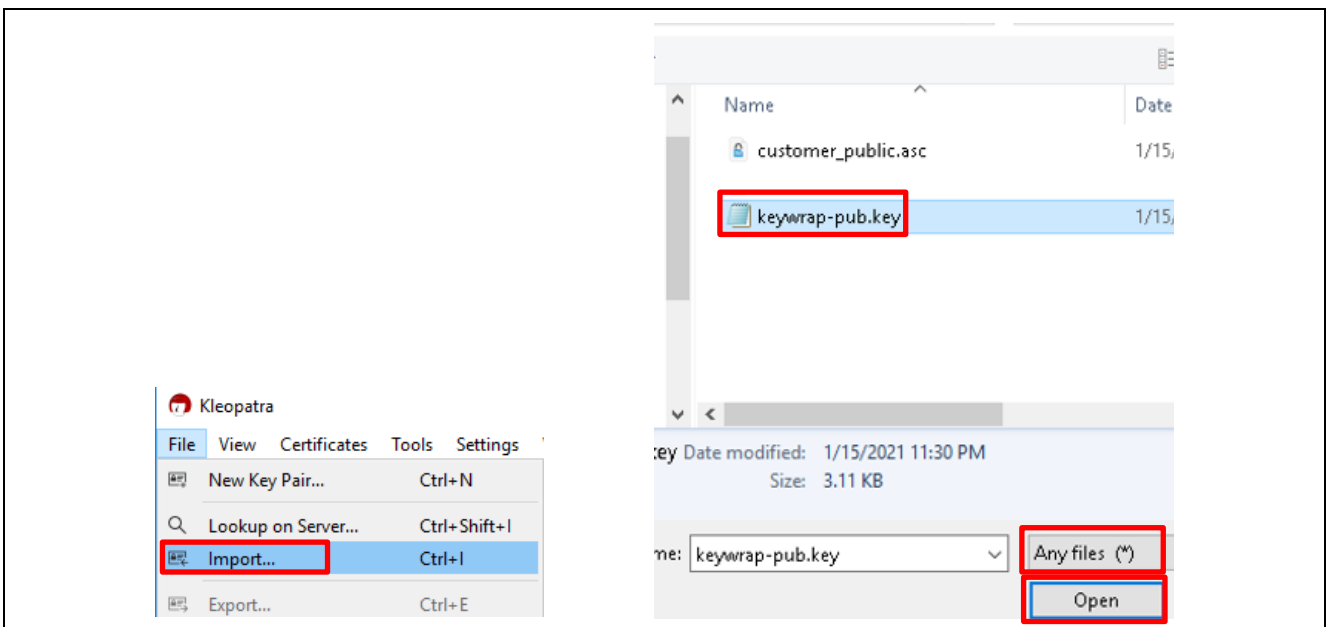

Figure 32. Import Renesas Public Key

9. After **Open** is clicked, a new item is added in Kleopatra as **not certified**.

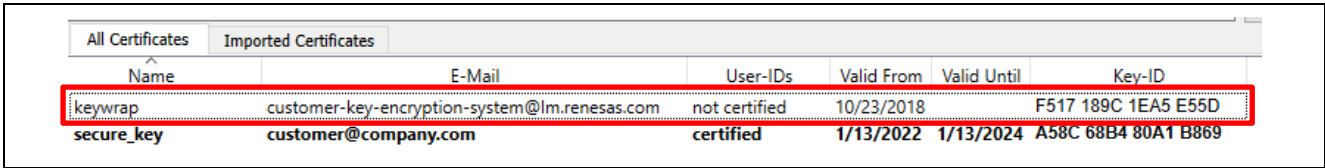

Figure 33. Renesas Public Key is Imported

10. Confirm that the Fingerprint displayed is the same as what is shown on the screen represented in Figure 29. Click **Certify**.

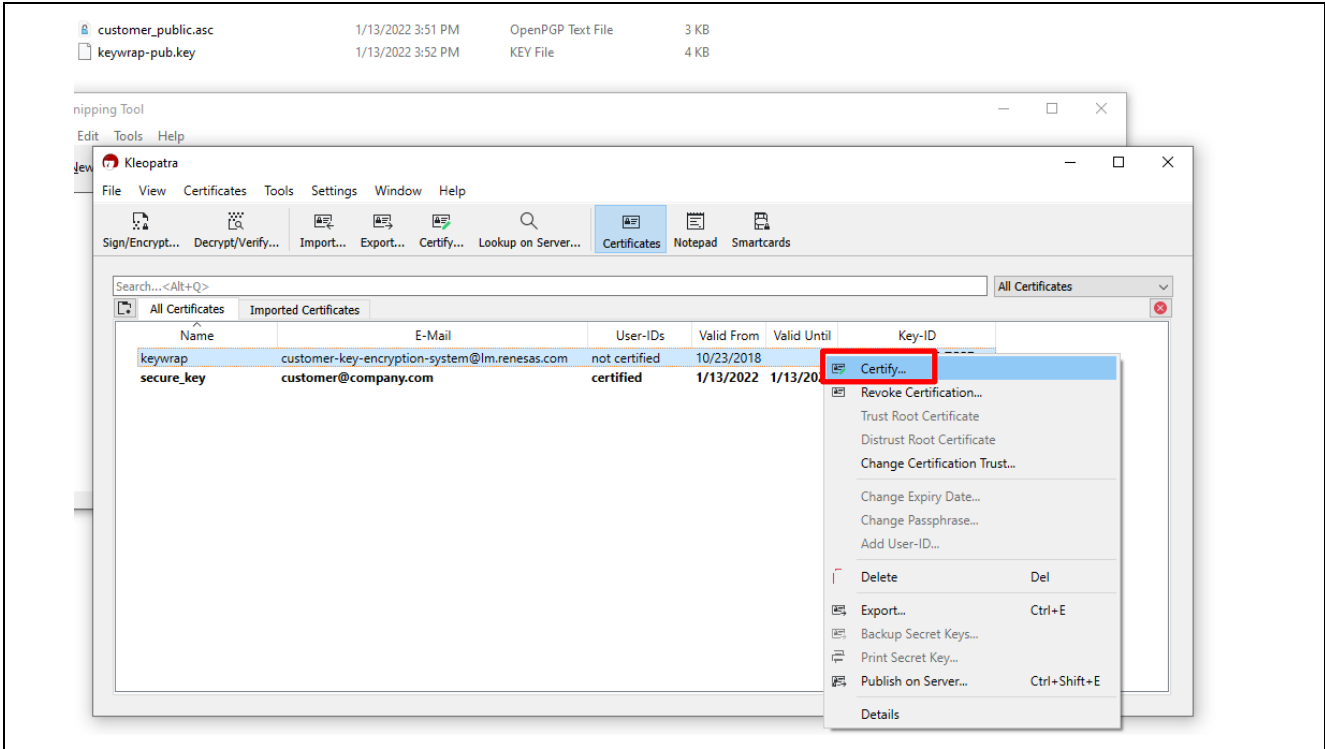

Figure 34. Confirm the Fingerprint and Certify the Renesas Public Key

11. Click **Certify** again from the following screen.

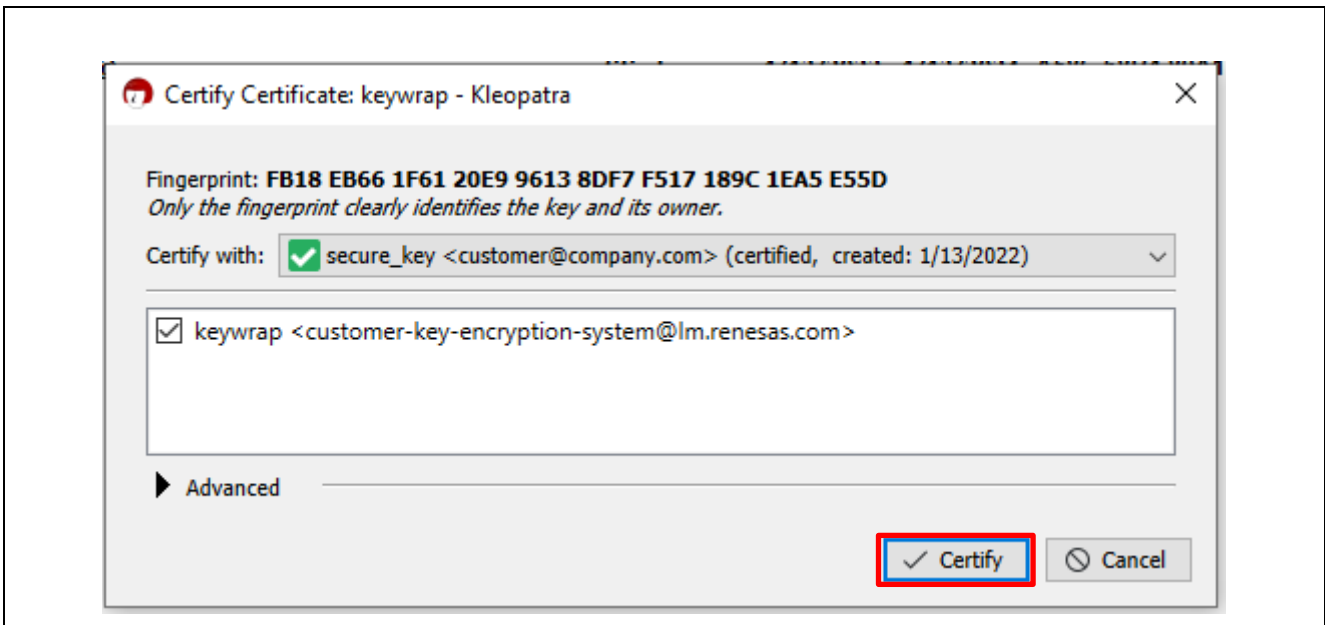

Figure 35. Certify the Certificate

12. Provide the passphrase to unlock the secure key.

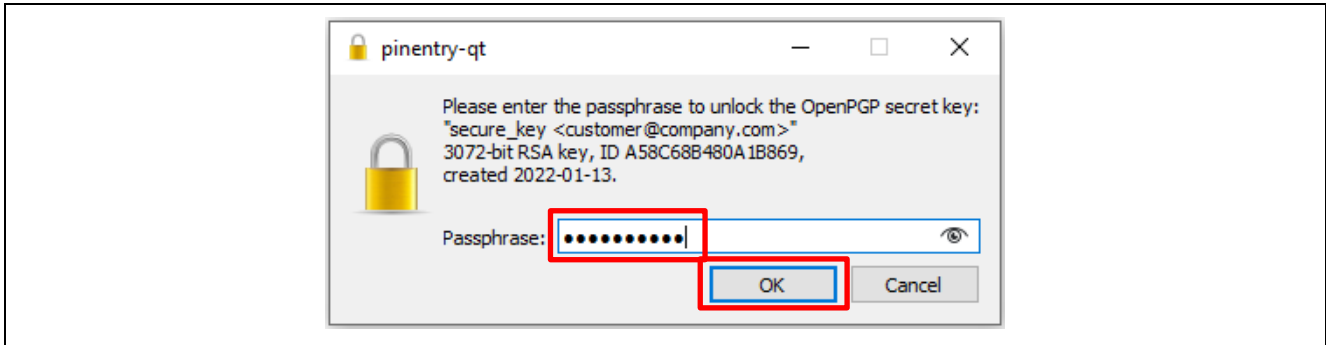

Figure 36. Provide the Passphrase

13. The following item will pop up upon successful certification. Click OK.

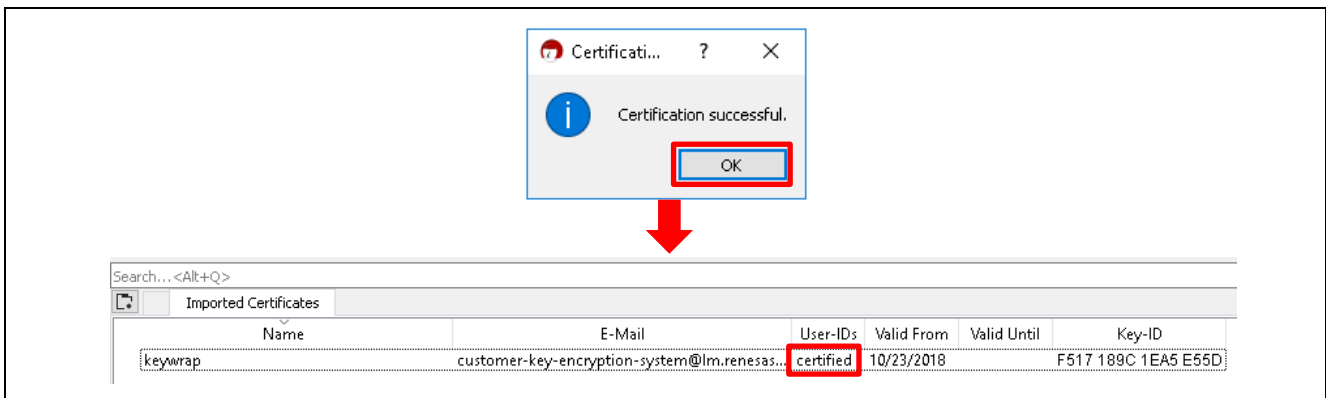

Figure 37. Successful Certification

4. Wrapping the User Factory Programming Key Using the Renesas Key Wrap Service

If you do not already have a W-UFPK for your target MCU Group, follow the steps below to wrap a UFPK with the Renesas Hardware Root Key as described by Figure 4.

4.1 Renesas Security Key Management Tool

The Renesas Security Key Management Tool (SKMT) performs several functions during the secure key injection process. Open the following link to access the latest SKMT:

<https://www.renesas.com/software-tool/security-key-management-tool>

From the above link, find the **Downloads** area and download the latest Security Key Management Tool installer. This tool supports Windows, Linux, and macOS. The screenshots in this document came from the Windows environment.

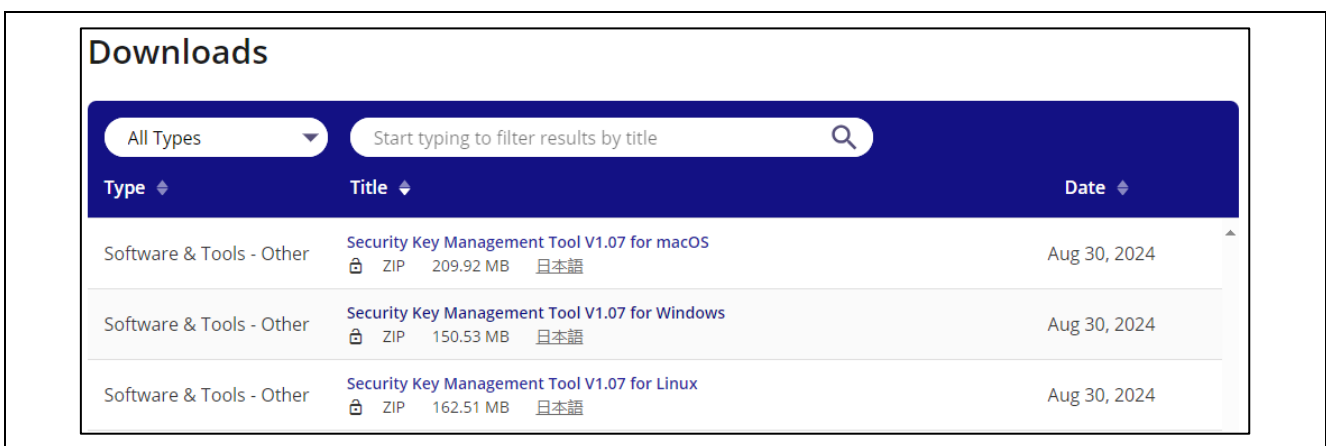

Figure 38. Download the Security Key Management Tool for Windows, Linux or macOS

Once the installer executable is downloaded, right-click on the installer and select **Run as administrator** to install this tool. Follow the prompt to select the **Setup Language**. Currently, both English and Japanese are supported. Next, select the installation folder. By default, it will be installed into `C:\Renesas\SecurityKeyManagementTool\`. If a previous version is installed, the old version will be overwritten.

The User's Manual of this tool is located in the `\DOC` folder. We recommend that you read through the user's manual before proceeding to the following section.

The SKMT provides two interfaces to users: a Command Line Interface (CLI) and a Graphic User Interface (GUI). The CLI interface is typically used for production support and the GUI interface is primarily intended for development usage. This application note will explain how to use both interfaces to perform key injection and update.

4.2 Creating the User Factory Programming Key using the SKMT GUI Interface

Define a UFPK and convert it to a binary format that is compatible with the Renesas Key Wrap Service. This can be done using the Renesas Security Key Management Tool (SKMT).

The same UFPK can be used for all RA Family MCUs. However, **the corresponding W-UFPK may be different** as it depends on the specific MCU Group. To avoid confusion and mistakes, it is recommended to choose the correct RA MCU Family when generating the UFPK using the SKMT GUI interface and name them different based on the MCU family.

Double-click **SecurityKeyManagementTool.exe** to launch the GUI interface.



Figure 39. Launch SKMT GUI Interface

To use the example projects included this application project, set the UFPK to `000102030405060708090A0B0C0D0E0F000102030405060708090a0b0c0d0e0f`

Note that the 32-byte UFPK must be provided in big-endian format.

It is important to select the correct MCU family and security engine mode when using the SKMT tool.

- RA8M1 has RSIP-E51A, for the RA8M1 compatibility mode example project included, in the **Overview** window, select **RA Family, RSIP-E51A Compatibility Mode**.

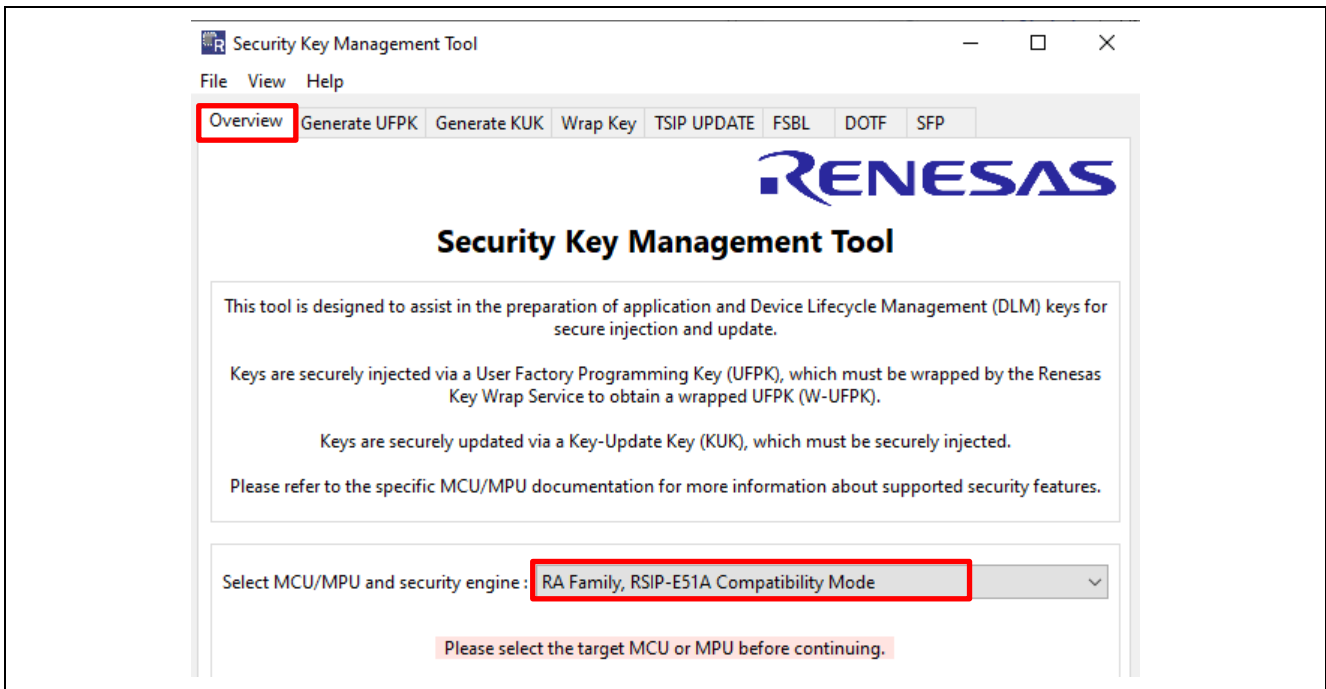

Figure 40. Select RA Family, RSIP-E51A Compatibility Mode

- RA6M4 has SCE9, for the protected mode example project included, in the **Overview** window, select **RA Family, SCE9 Security Functions, and Protected Mode**.

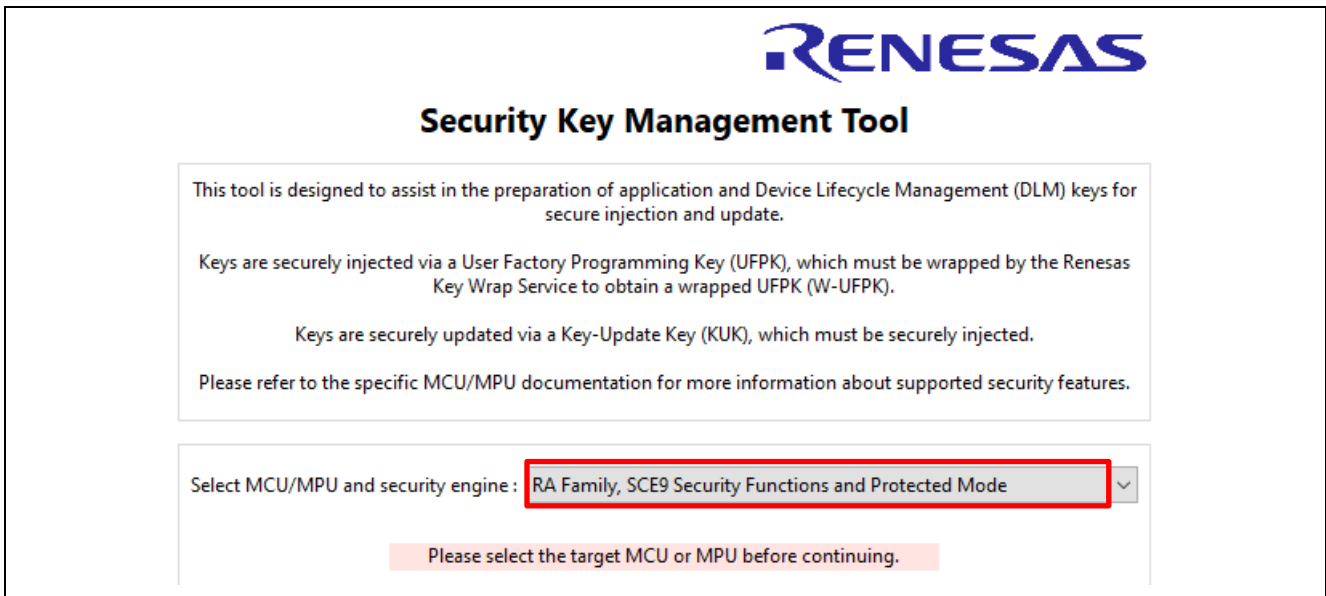

Figure 41. Select RA Family, SCE9 Protected Mode

- RA6M3 has SCE7, for the SCE7 example project included, in the **Overview** window, select **RA Family, SCE7**

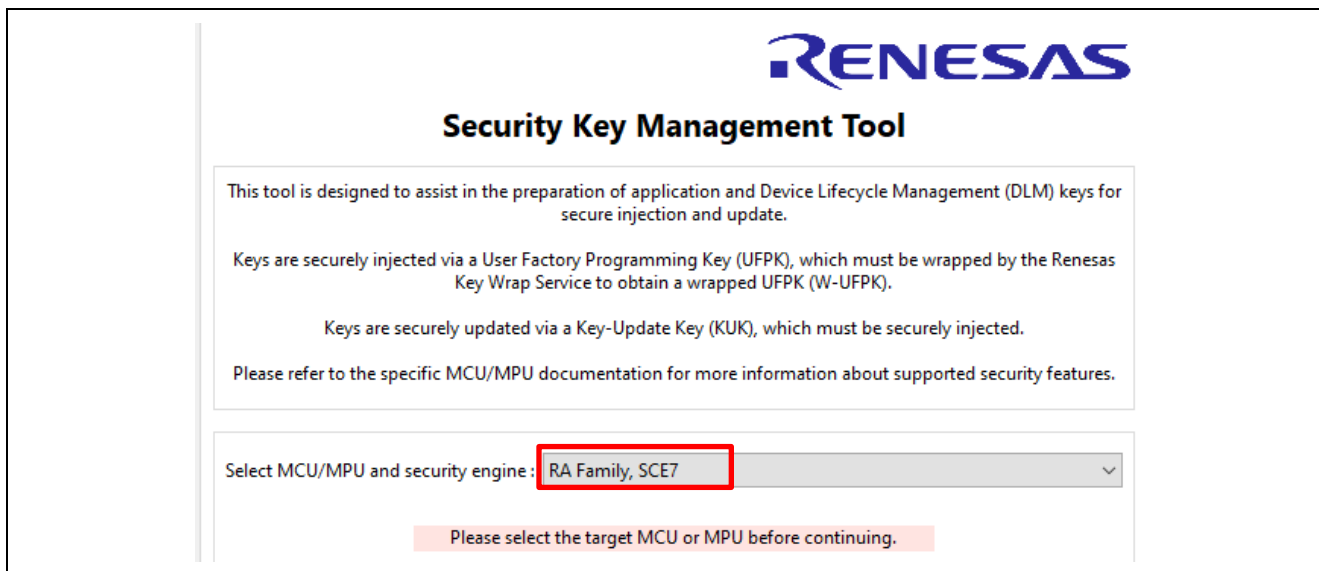

Figure 42. Select RA Family, SCE7

Once the correct MCU Family, Security Engine, and Mode are selected, navigate to the **Generate UFPK** page.

- For the **User Factory Programming Key**, select **Use specified value**.
- Click the **Browse** button to select a folder to store the key and name the resulting file.
It is recommended that users choose different file names for the different MCU families to avoid confusion at the UFPK wrapping stage. In this example, we name the file `ra8x1_ufpk.key`.

Click **Generate UFPK key file**. The `ra8x1_ufpk.key` file will be generated. Similarly, the UFPK for RA6M4 and RA6M3 can also be generated.

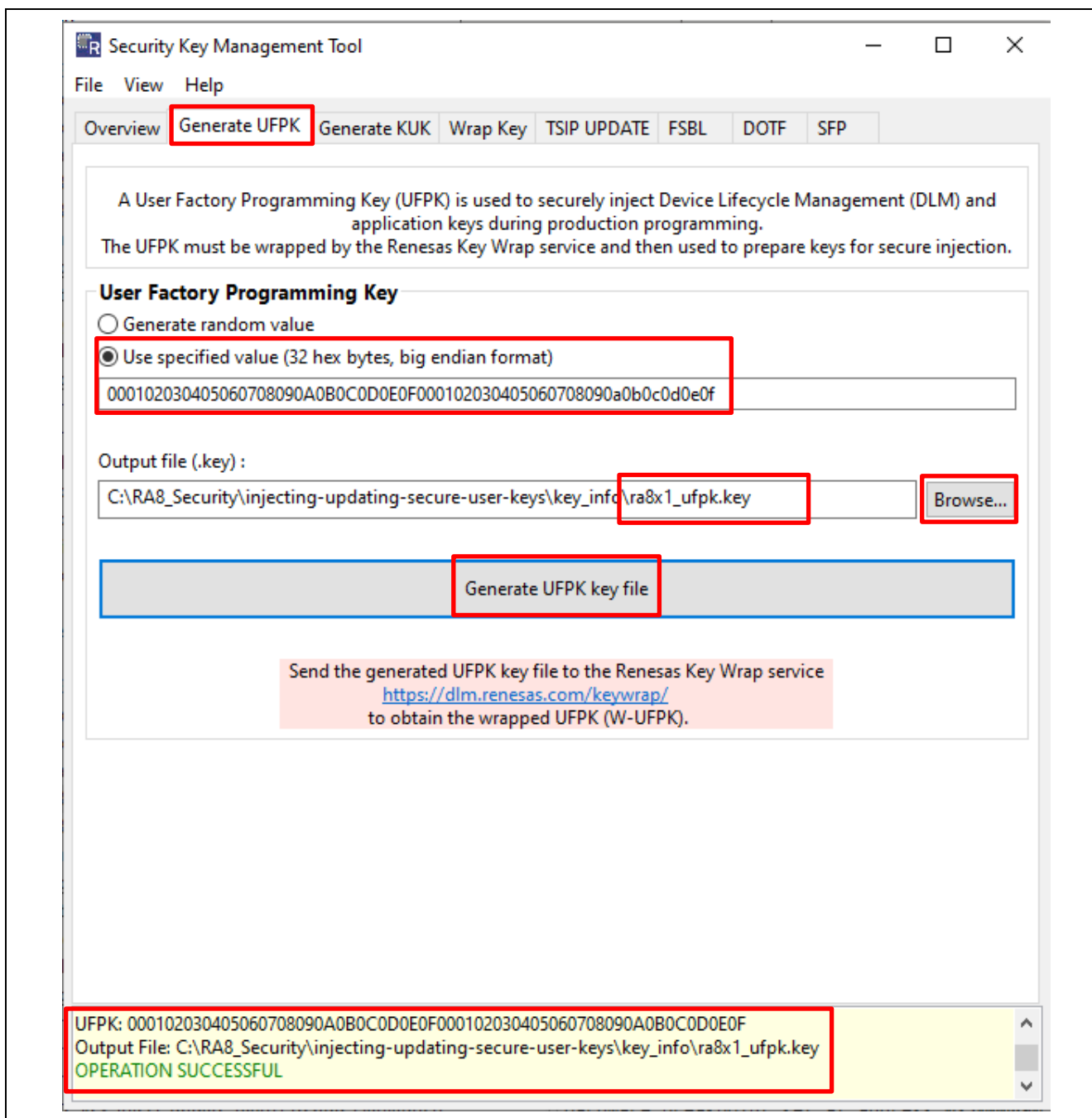

Figure 43. Generate Fixed UFPK using GUI for RSIP-E51A

Optionally, the user can also choose the **Generate random value** option to generate the UFPK.

4.3 Creating the User Factory Programming Key using the CLI Interface

Open a Command Prompt window and navigate to the folder where `skmt.exe` resides, typically under `\Renesas\Security Key Management Tool\CLI\`.

Use the following command to generate a random UFPK and place it in a key file (`ufpk.key`). If desired, a complete file name with a path may be specified. Refer to the Security Key Management Tool user's manual to understand the usage of `/genufpk` option.

```
skmt.exe /genufpk /output "C:\User_key_injection_protected_mode\keys\ufpk.key"
```

This command will generate a random 256-bit UFPK as shown below.

```
UFPK: E8AB23E99C9AD42823DA4215549A41496720F7243680A4715F4B944ACC94B691
Output File: C:\User_key_injection_protected_mode\keys\ufpk.key
```

Figure 44. Create a Random UFPK Using SKMT CLI

It is also possible to specify a specific UFPK, as shown by the following command:

```
skmt.exe /genufpk /ufpk
"000102030405060708090A0B0C0D0E0F000102030405060708090a0b0c0d0e0f" /output
"C:\User_key_injection_protected_mode\keys\ufpk.key"
```

```
UFPK: 000102030405060708090A0A0C0D0E0F000102030405060708090a0b0c0d0e0f
Output File: C:\User_key_injection_protected_mode\keys\ufpk.key
```

Figure 45. Create a Fixed UFPK Using SKMT CLI

4.4 Wrapping the UFPK

The next step is to obtain a W-UFPK from the Renesas Key Wrap Service based on the selected UFPK. Note that if the UFPK is changed, a new W-UFPK must be obtained.

1. Launch the Kleopatra program.
2. Encrypt the UFPK with the Renesas public key. This key was imported earlier to Kleopatra. Using Kleopatra, select **Sign/Encrypt...** and select the UFPK file. In this screenshot, an example file named `ufpk_ra6m3.key` file is used for demonstration purposes. Then click **Open**.

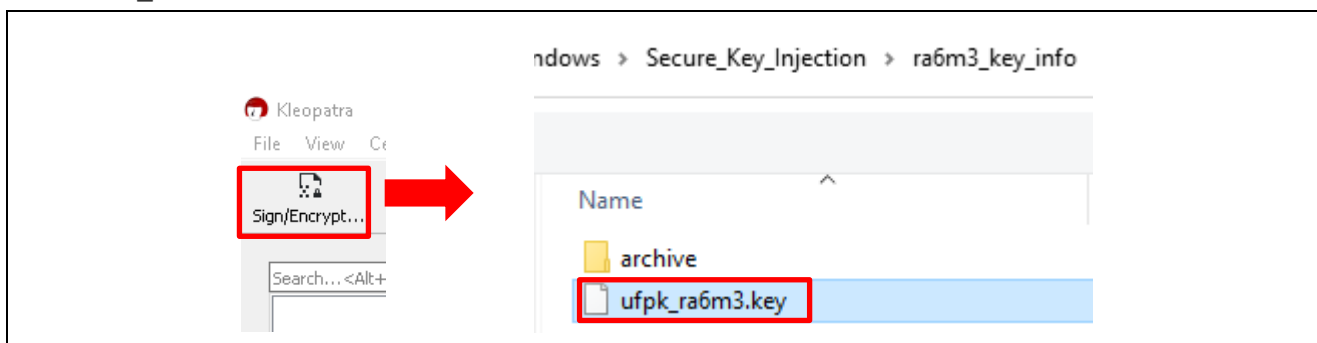

Figure 46. Encrypt the UFPK File for PGP Transfer

- When asked which entity this file is to be encrypted for, (optionally) uncheck **Encrypt for me** and check **Sign as, Encrypt for others, and Encrypt / Sign each file separately**.

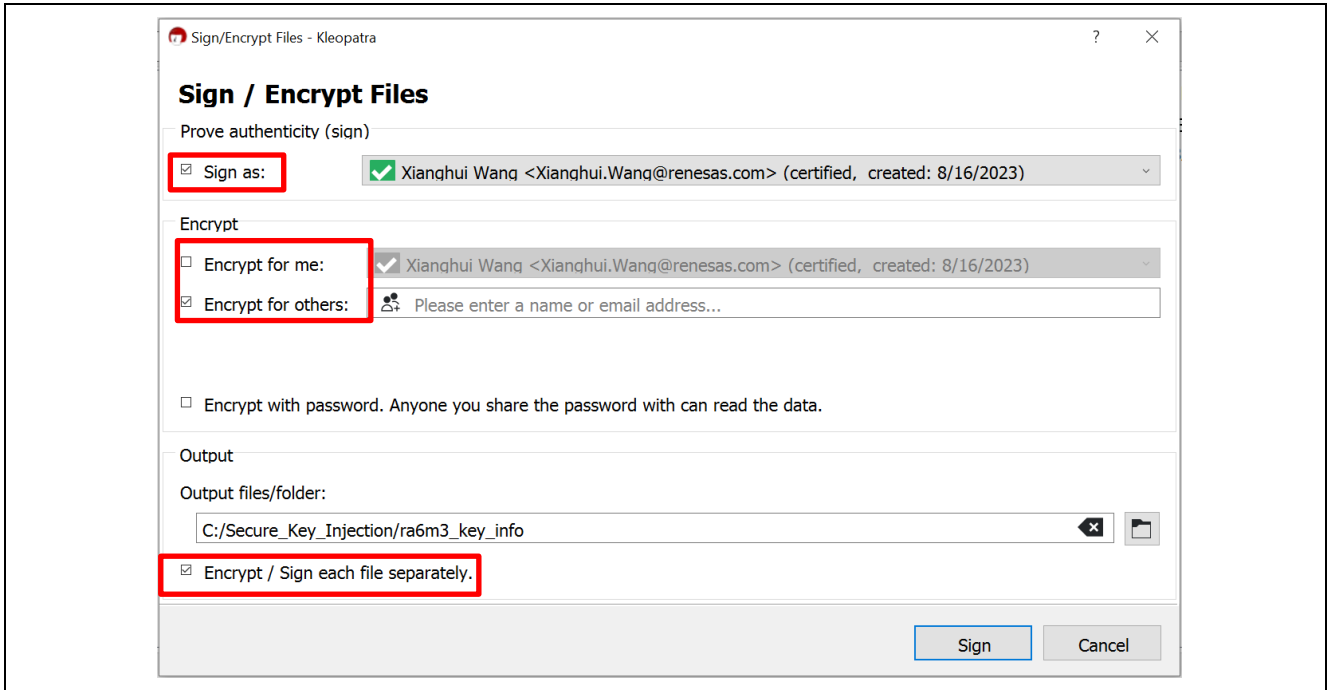

Figure 47. Select PGP Encryption Options

- Click the **Open Selection Dialog** (the icon). This will open a **Certificate Selection** dialog box.

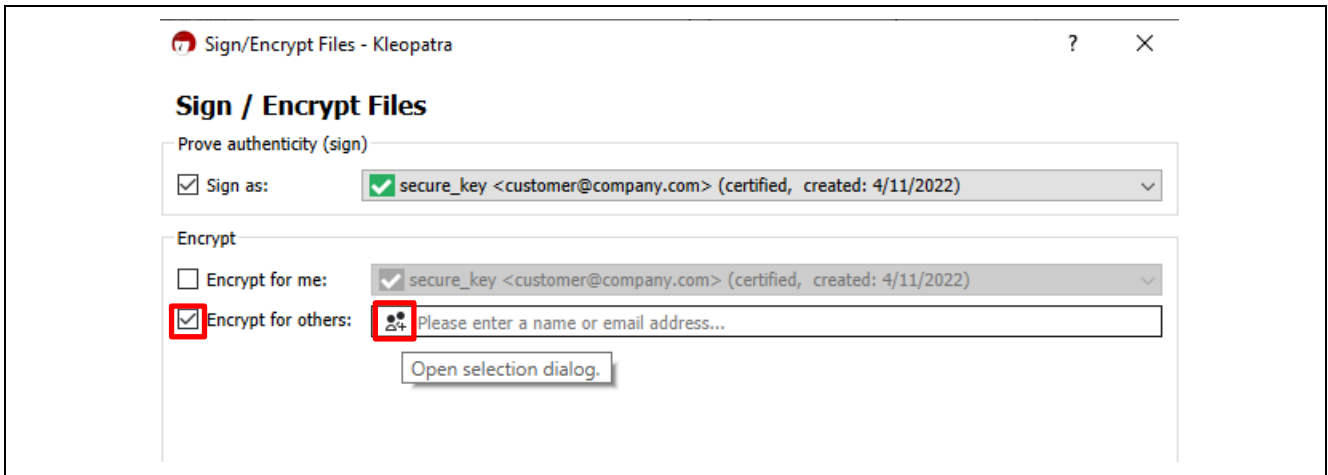

Figure 48. Open the Selection Dialog

- In this window, select **keywrap** to select the Renesas public key, then click **OK**

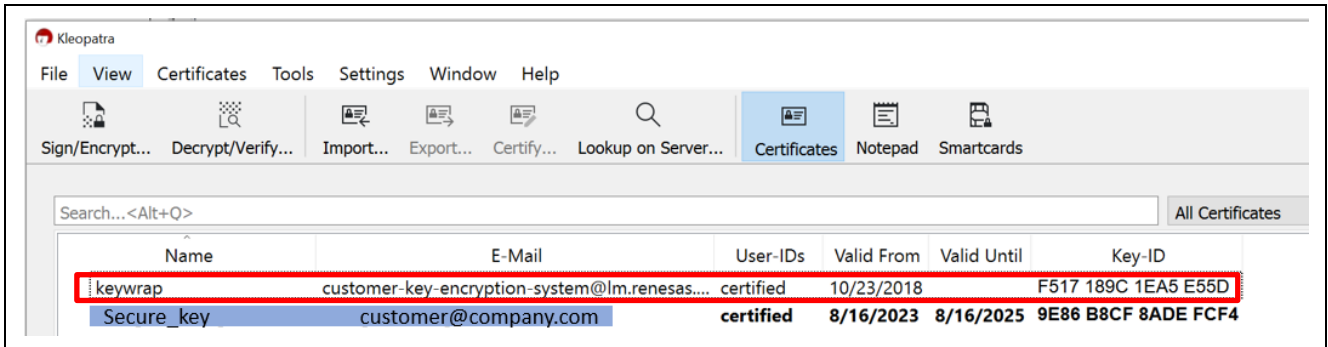

Figure 49. Select the Renesas PGP Public key

6. Ensure that the correct destination folder for the encrypted key is selected under **Output**. Finally, click **Sign/Encrypt**. It is a good practice to keep UFPK and W-WUPK for different MCU families in different folders and under different names.

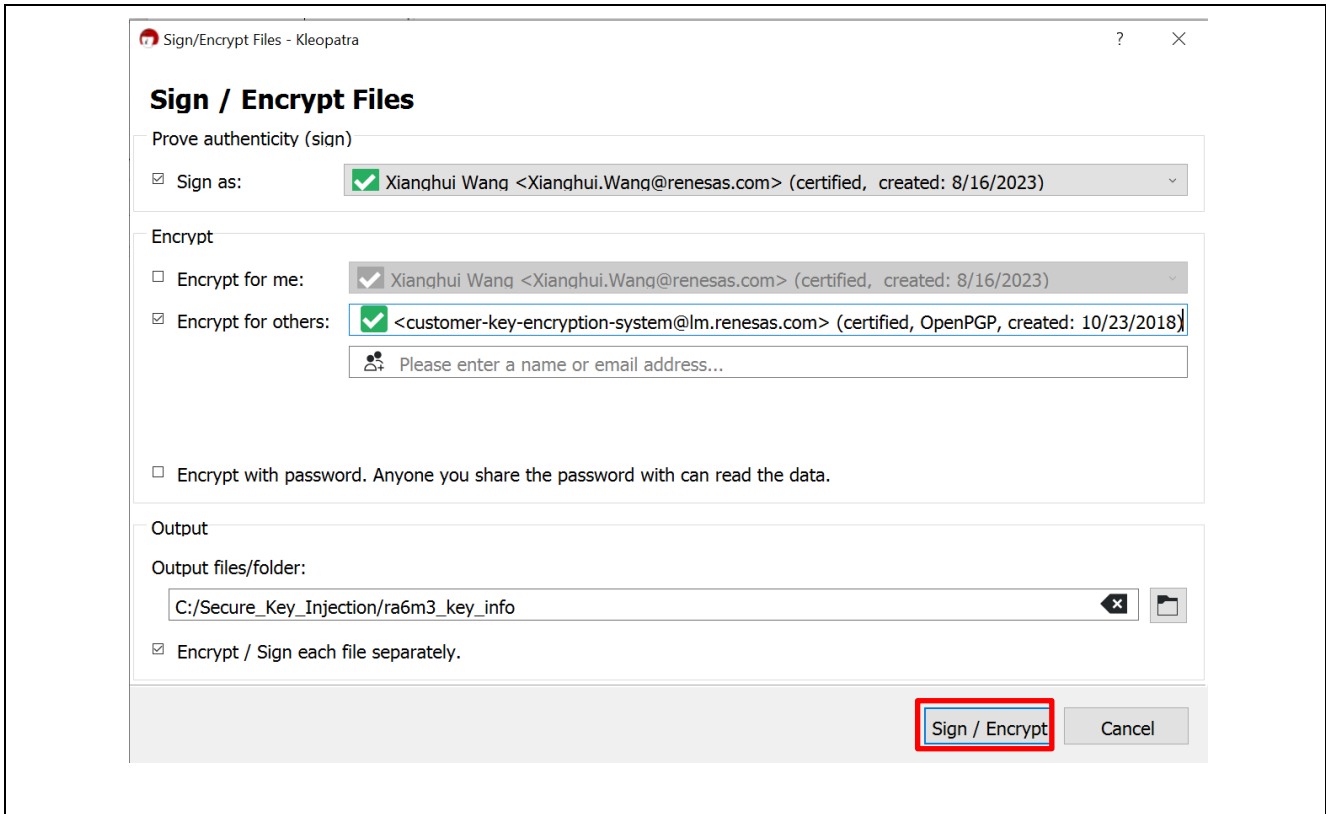

Figure 50. Encrypt UFPK using Renesas PGP Public Key

7. If you do not check **Encrypt for me**, you will get an **Encrypt-To-Self Warning** that you cannot decrypt the data. Click **Continue**.

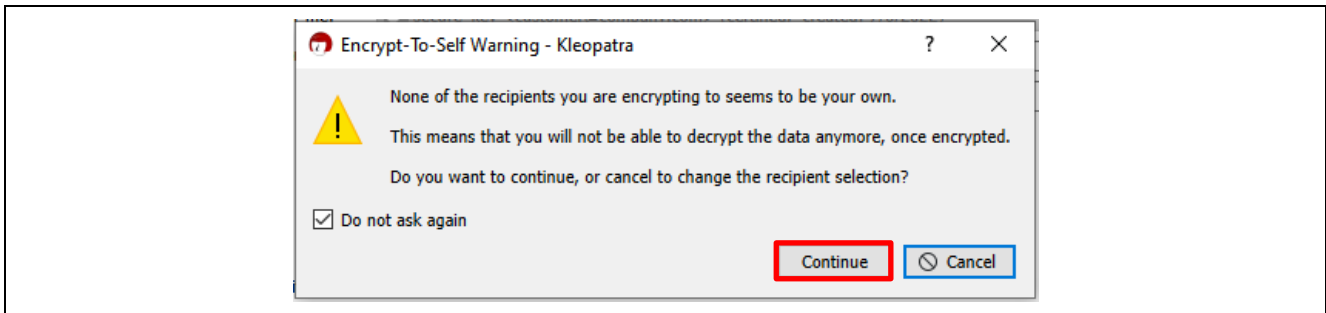

Figure 51. Start the UFPK Encryption process

8. Provide your private key passphrase, then click **OK**.

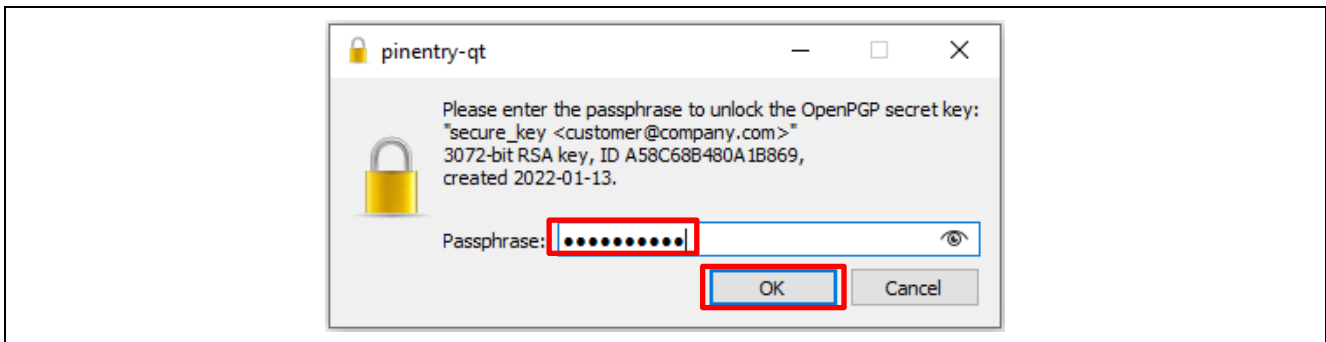

Figure 52. Provide Passphrase

- The UFPK encrypted with the Renesas public key will be generated, with the .gpg added to the extension of the key. In this case, the file `ufpk_ra6m3.key.gpg` is generated. Click **Finish**.

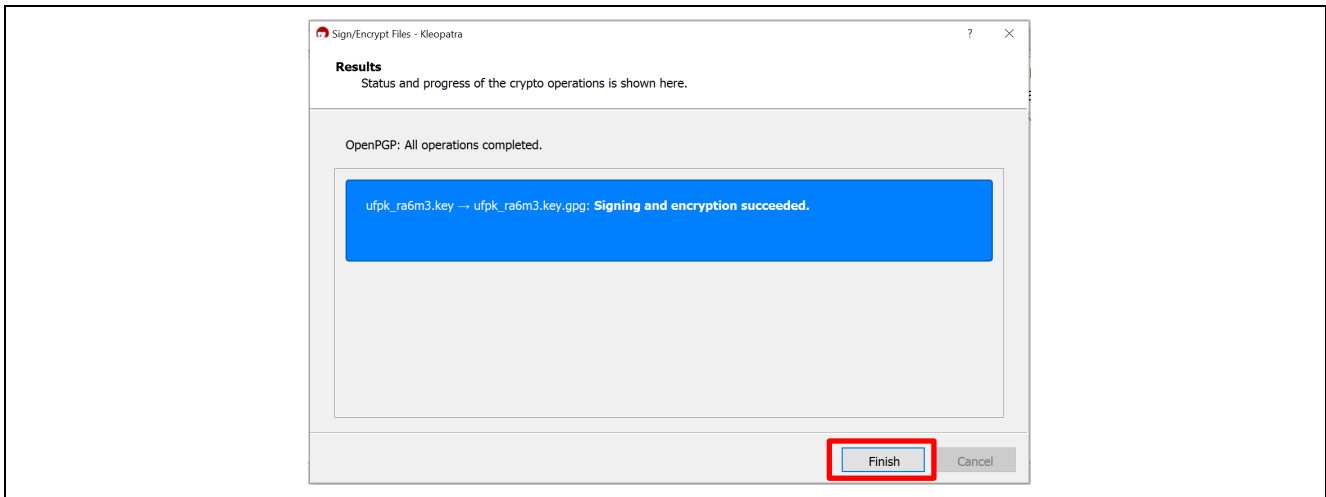

Figure 53. Encrypted Key is Generated

- Now, we can send the UFPK that has been encrypted with Renesas Public Key to the Renesas DLM Server for wrapping. Return to the DLM Server web page:



Figure 54. Select the MCU Family

When generating the Wrapped UFPK, it is important to select the correct MCU family and security engine mode.

- To create a W-UFPK for the RA8M1 Compatible Mode secure key injection example project, select the Renesas RA Family and click Compatibility Mode **RA8M1 Encryption of customer's data**.

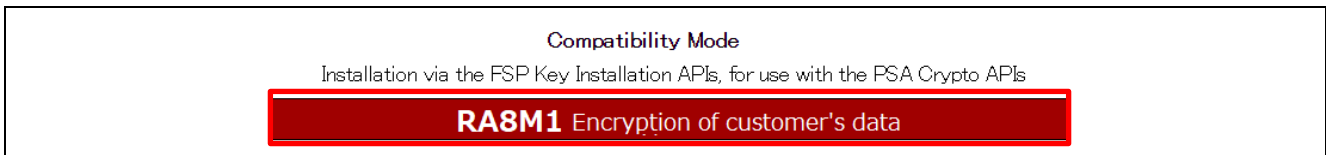

Figure 55. Select the RA8M1 MCU Group Compatibility Mode

- To create a W-UFPK for the RA6M4 example project, select the **Renesas RA** Family and click Protected Mode **RA6M4/RA6M5 Encryption of customer's data**.

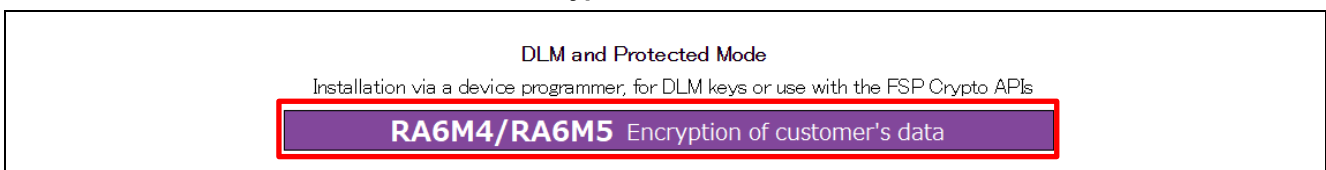

Figure 56. Select the RA6M4/RA6M5 MCU Group DLM and Protected Mode

- To create a W-UFPK for the RA6M3 example project, select the **Renesas RA Family** and click Compatibility Mode **RA6M1/RA6M2/RA6M3/RA6T1 Encryption of customer's data**.

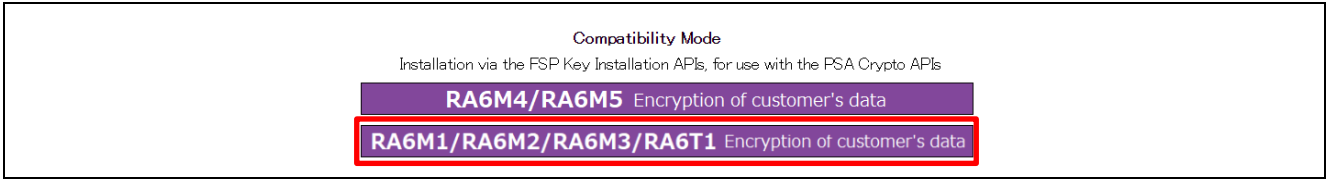

Figure 57. Select the RA6M1/RA6M2/RA6M3/RA6T1 MCU Group Compatibility Mode

- Click **Encryption service for products** on the next screen. Here, the screenshot uses RA6M3 as an example; for other MCU families, a similar screen will be presented.

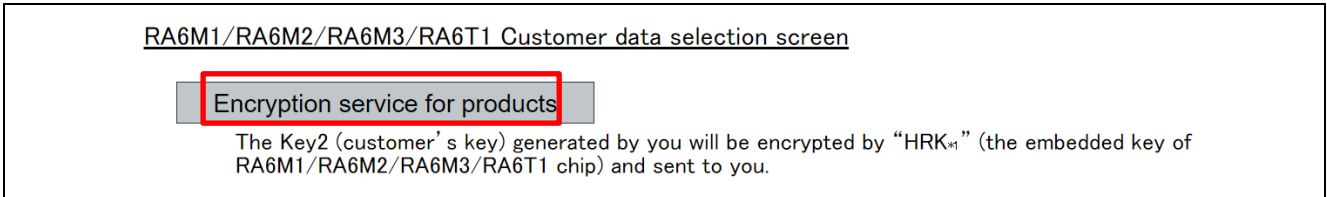

Figure 58. Choose Encryption service for products

- Click **Reference** and select the corresponding encrypted UFPK; example shown is `ufpk_ra6m3.key.gpg` created previously, and click **Open**. Note that in the DLM server description, **Key2** refers to the UFPK.

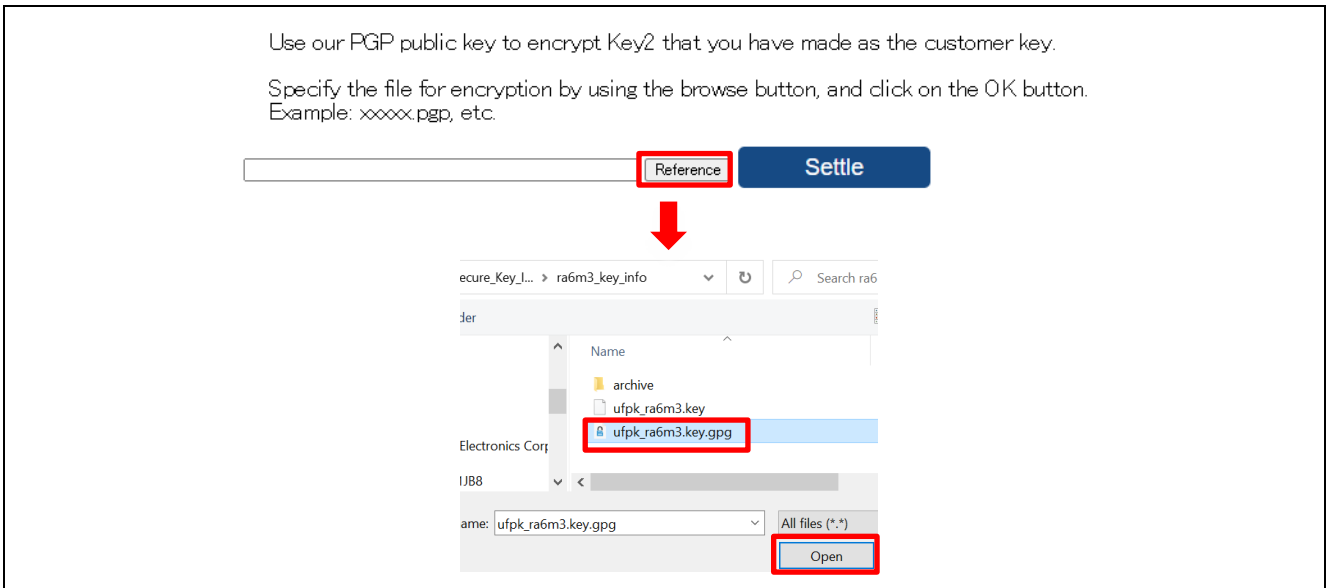

Figure 59. Select the PGP-Encrypted UFPK file

- Click **Settle**. The following message will be printed. Then click **Return to the menu**. You can now log out of the Renesas Key Wrap Service.

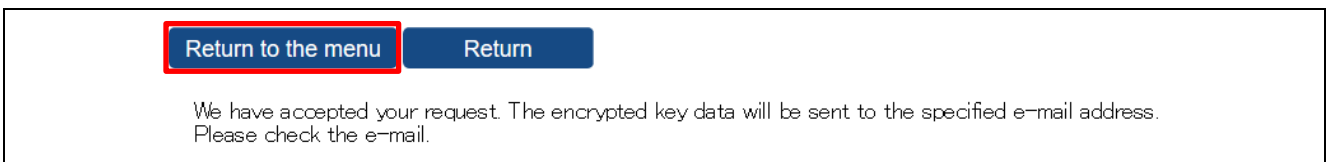

Figure 60. Return to the DLM Server Main Menu

- The wrapped UFPK Key (W-UFPK) encrypted with your PGP public key should arrive in your email typically in about 1-2 minutes. Save the attached file.

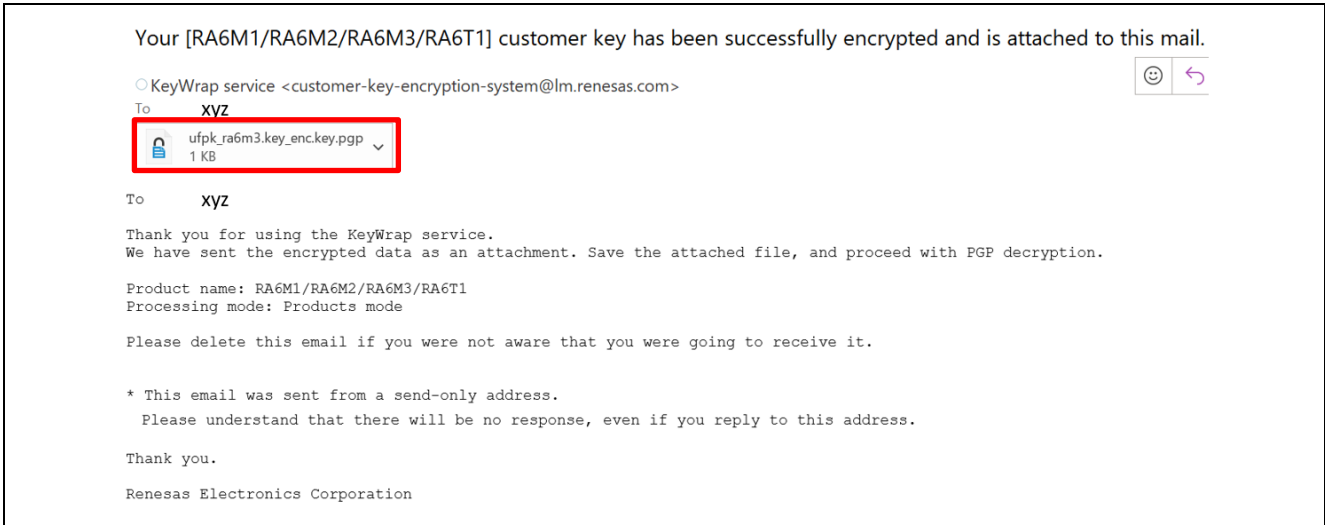

Figure 61. Receiving the W-UFPK via Email

- With the Kleopatra program, click **Decrypt/Verify**, select the W-UFPK file, and click **Open**.

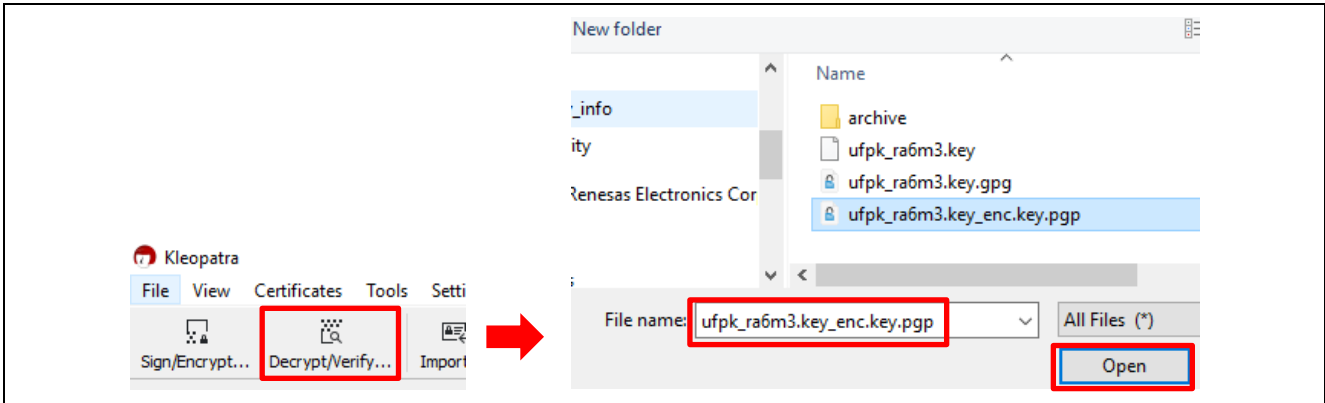

Figure 62. Decrypt the W-UFPK

- Follow the prompt to provide your PGP private key passphrase and click **OK**. The decrypted W-UFPK is generated in the folder specified.

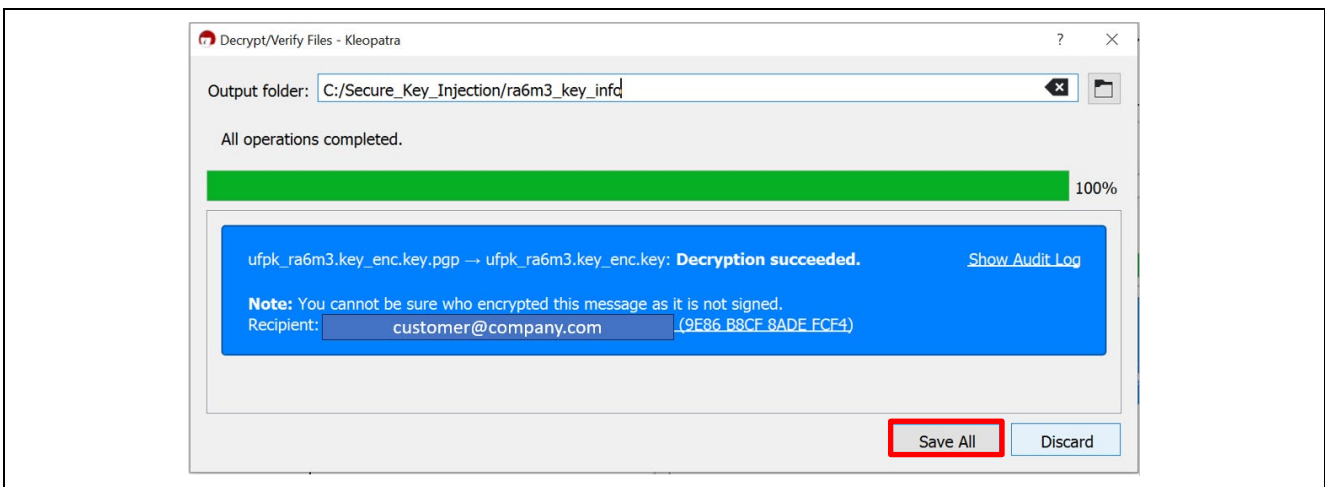

Figure 63. Decrypting the Encrypted W-UFPK

- Click **Save All** to save the decrypted W-UFPK key file `ufpk_ra6m3.key_enc.key` to the same folder as the UFPK key file. Both key files are required to generate key injection bundles.

5. Secure Key Injection for SCE9 Protected Mode

5.1 Wrap Keys with the UFPK and W-UFPK

This section walks the user through the wrapping process required for secure key injection and update. The SKMT tool is used to perform this key-wrapping process.

Step-by-step instructions for generating the three types of keys are provided using both the CLI and GUI interfaces of the SKMT.

- **User Key** wrapping with the UFPK for secure key injection of the user key
- **Key-Update Key** wrapping with the UFPK for secure key injection of the KUK
- **User Key** wrapping with the KUK for secure key update of the user key

This application project provides examples of user key wrapping of both AES-256 and ECC secp256r1 public keys.

5.1.1 Using the SKMT GUI Interface

To prepare a Protected Mode user key to inject using RFP, we need the UFPK, W-UFPK, and the user key as input to the SKMT GUI interface.

Launch the SKMT GUI and select **RA Family, SCE9 Security Functions, and Protected Mode** on the **Overview** tab. On the **Wrap Key** tab, open the submenu **Key Type**. This page can be used to choose which key type to prepare.

5.1.1.1 Wrap an Initial AES-256 Key with the UFPK

A NIST CAVP test vector is used for this purpose.

<https://csrc.nist.gov/Projects/Cryptographic-Algorithm-Validation-Program/Block-Ciphers>

```
KEY = 8000000000000000000000000000000000000000000000000000000000000000
IV = 0000000000000000000000000000000000000000000000000000000000000000
PLAINTEXT = 0000000000000000000000000000000000000000000000000000000000000000
CIPHERTEXT = e35a6dcb19b201a01ebcfa8aa22b5759
```

Figure 64. NIST AES 256 Test Vector

In the **Key Type** area, choose **Key Type** and specify **AES** with **256 bits**.

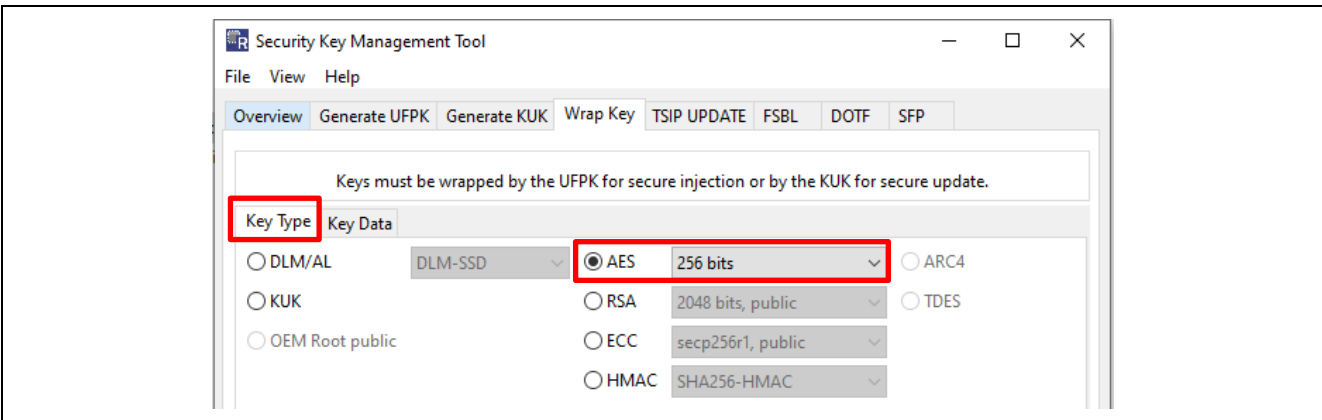

Figure 65. Choose AES 256 bits as the Key Type

Navigate to the **Key Data** page and input the **Raw** key data as shown below based on the NIST vector shown in Figure 64. The key data is duplicated here to easily copy and paste to the GUI interface.

KEY = 8000

Test Vectors

Use of these test vectors does not replace validation obtained through the CAVP.

The test vectors linked below can be used to informally verify the correctness of digital signature algorithm implementations (in FIPS 186-2 and FIPS 186-4) using the validation systems [listed above](#).

Response files (.rsp): the test vectors are properly formatted in response (.rsp) files. Vendor response files must match this format exactly.

Intermediate results files (.txt): files with intermediate results (.txt) are supplied to help with debugging.

See the README file in each zip file for details.

Publication	Algorithm Test Vectors
FIPS 186-4	DSA ECDSA RSA
FIPS 186-2	DSA ECDSA RSA

Figure 68. ECDSA Test Vectors

After downloading the zip file 186-4ecdsatestvectors.zip, unzip it. The following vectors can be found in the plaintext file SigGen.txt.

```

Msg =
5905238877c77421f73e43ee3da6f2d9e2ccad5fc942dcec0cb25482935faaf416983fe165b1a045ee2bcd2
e6dca3bdf46c4310a7461f9a37960ca672d3feb5473e253605fb1ddfd28065b53cb5858a8ad28175bf9bd386
a5e471ea7a65c17cc934a9d791e91491eb3754d03799790fe2d308d16146d5c9b0d0deb97d79ce8
Qx = 1ccb91c075fc7f4f033bfa248db8fccd3565de94bbfb12f3c59ff46c271bf83
Qy = ce4014c68811f9a21a1fdb2c0e6113e06db7ca93b7404e78dc7ccd5ca89a4ca9
R = f3ac8061b514795b8843e3d6629527ed2afd6b1f6a555a7acabb5e6f79c8c2ac
S = 8bf77819ca05a6b2786c76262bf7371cef97b218e96f175a3ccdda2acc058903
    
```

Figure 69. NIST ECC secp256r1 Test Vector

Launch the SKMT GUI and select **RA Family**, **SCE9 Security Functions**, and **Protected Mode** on the **Overview** tab. On the **Wrap Key** tab, select the **Key Type** as **ECC** and **secp256r1, public**, as shown in Figure 70.

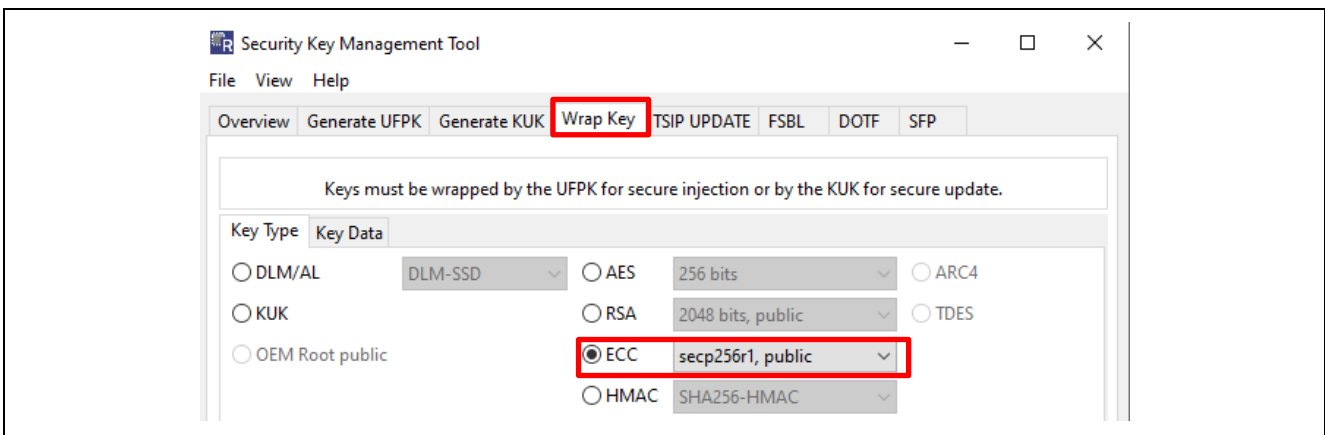

Figure 70. Choose secp256r1 Public Key

Next, configure the **Key Data**. Under the **Key Data** area, select **Raw** and provide the **Qx** and **Qy** as shown below. The key data is duplicated here to easily copy and paste to the GUI interface.

Qx = 1ccb91c075fc7f4f033bfa248db8fccd3565de94bbfb12f3c59ff46c271bf83

Qy = ce4014c68811f9a21a1fdb2c0e6113e06db7ca93b7404e78dc7ccd5ca89a4ca9

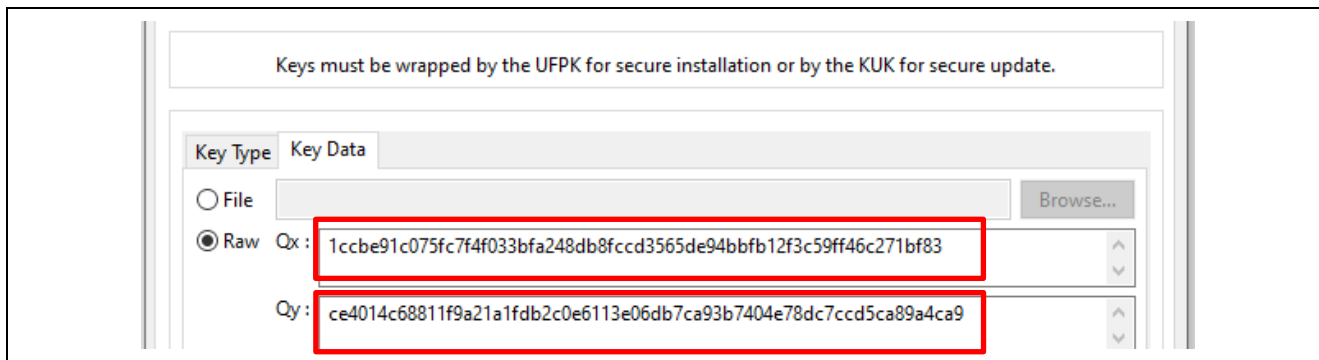

Figure 71. Provide the ECC Public Key data

Next, under the **Wrapping Key** section, click the corresponding **Browse** buttons to select the **UFPK** and **W-UFPK** key pair created in section 4.2 and 4.4. For the **IV**, select **Generate random value**. For the **Output** option, select **RFP**; then click the **Browse** button, choose the output folder, and name the output file.

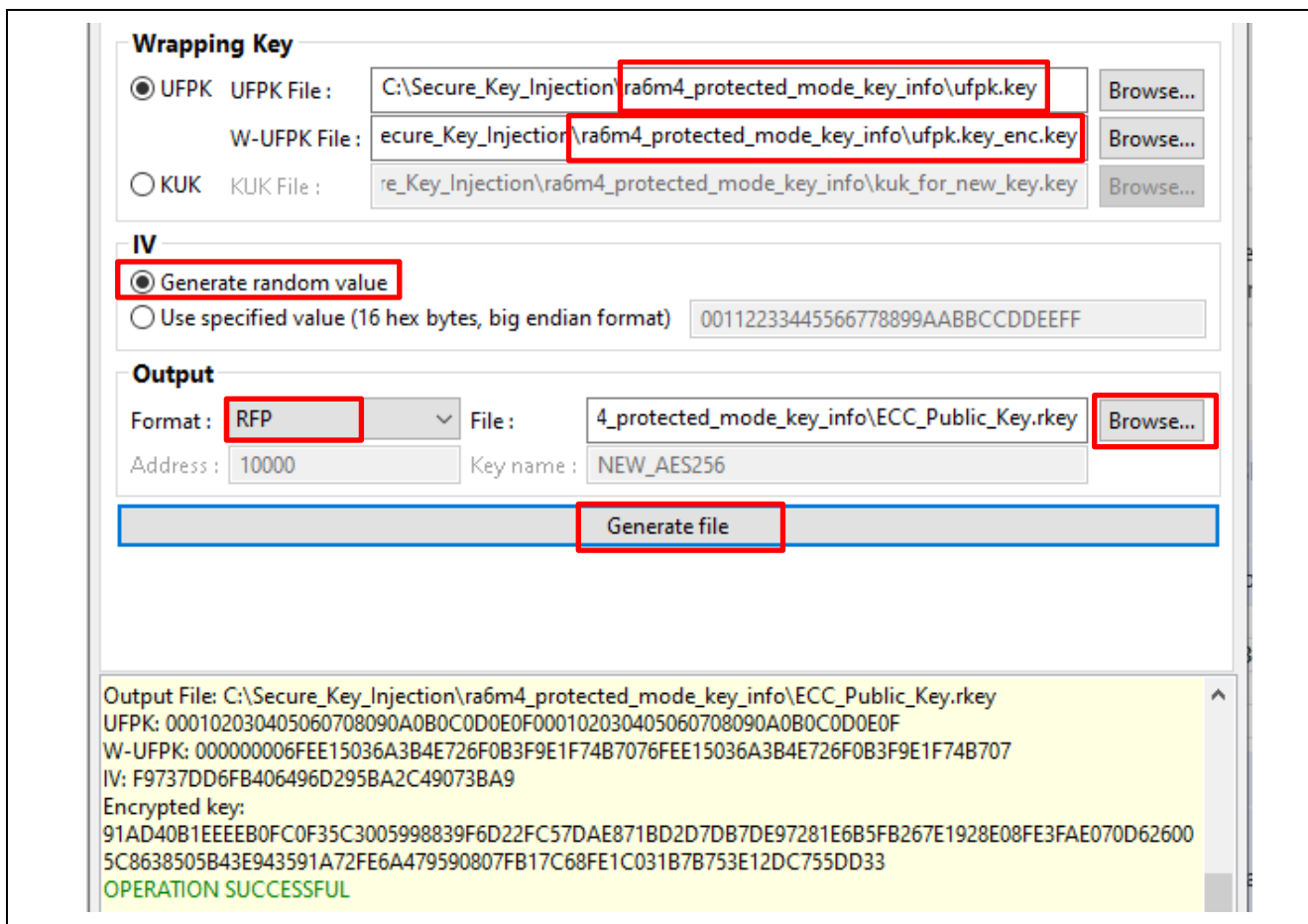

Figure 72. Generate the ECC Public Key RFP Injection Key File using GUI

The plaintext KUK and UFPK are NOT contained in the *.rkey file, enabling confidential transfer of the key injection file contents.

5.1.1.3 Wrap a Key-Update Key with the UFPK

The SKMT can be used to generate a sample KUK. To generate the KUK key file, navigate to the **Generate KUK** tab and use: `000102030405060708090a0b0c0d0e0f000102030405060708090a0b0c0d0e0f`.

Click the **Browse** button to select the folder and file name for the generated key file, here specified as `kuk_for_new_key.key`. Next, click **Generate KUK key file**, and the `kuk_for_new_key.key` file will be generated in the selected folder.

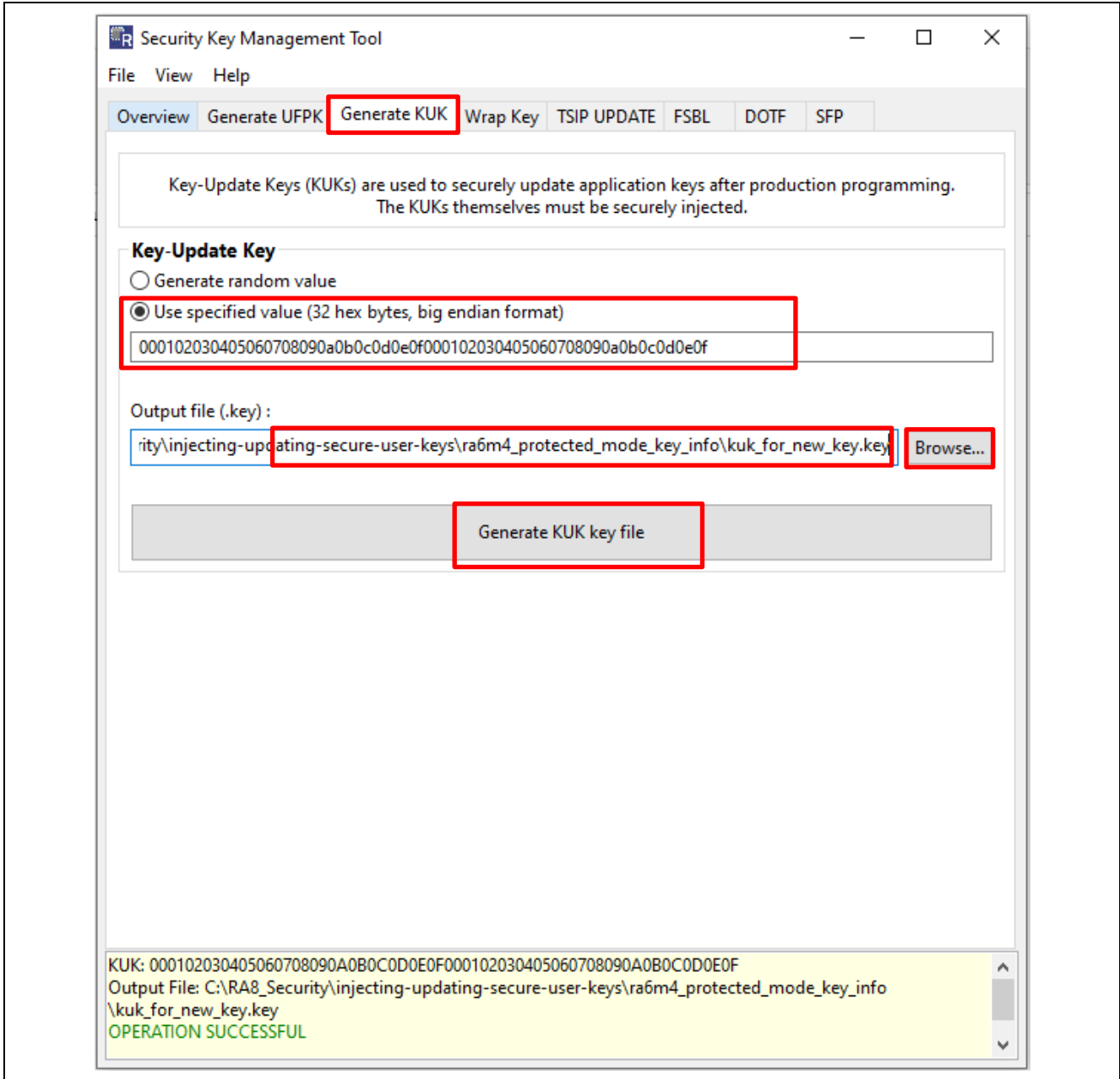

Figure 73. Generate the KUK File used to Encrypt the User Key for SCE9

Next, we will wrap the KUK so it can be injected into the MCU. Navigate to the **Wrap Key** page and choose **KUK** from the **Key Type** area.

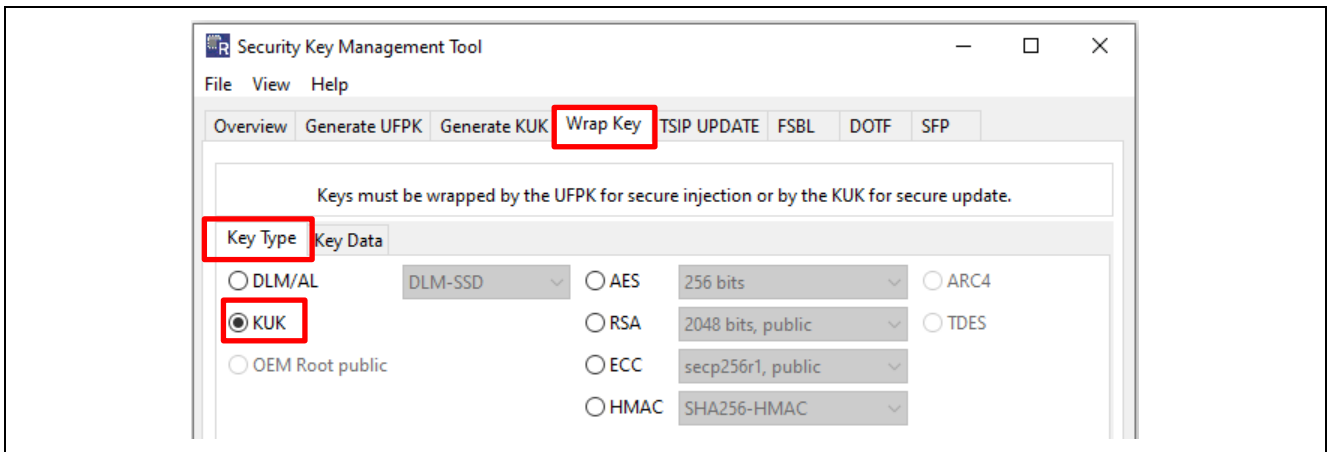

Figure 74. Choose KUK to Wrap

Navigate to the **Key Data** page, select the **File** option, and browse to the `kuk_for_new_key.key` key file generated in Figure 73.

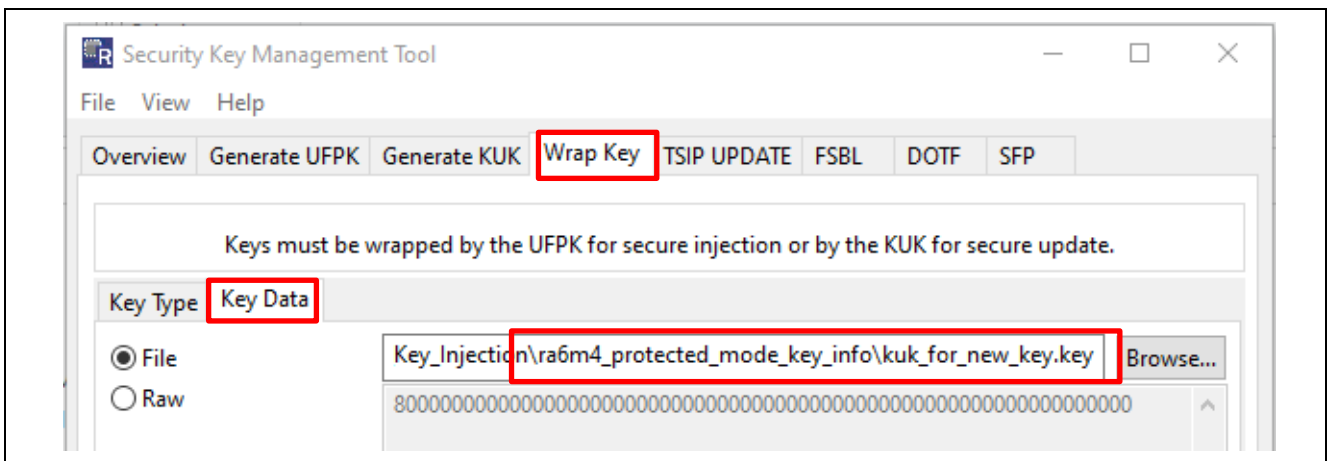

Figure 75. Provide the KUK .key File

5.1.1.5 Wrap a New ECC Public Key with the KUK

In the section, we will use the `kuk_for_new_key.key` generated in Figure 73 to wrap a new ECC Public key.

To demonstrate updating the ECC public key, another NIST ECC secp256r1 test vector is used in this application project. This test vector can be found in `SigGen.txt`, downloaded based on Figure 68.

```
Msg =
c35e2f092553c55772926bdbe87c9796827d17024dbb9233a545366e2e5987dd344deb72df987144b8c6c43b
c41b654b94cc856e16b96d7a821c8ec039b503e3d86728c494a967d83011a0e090b5d54cd47f4e366c0912bc
808fbb2ea96efac88fb3ebec9342738e225f7c7c2b011ce375b56621a20642b4d36e060db4524af1
Qx = e266ddfdc12668db30d4ca3e8f7749432c416044f2d2b8c10bf3d4012aeffa8a
Qy = bfa86404a2e9ffe67d47c587ef7a97a7f456b863b4d02cfc6928973ab5b1cb39
R = 976d3a4e9d23326dc0baa9fa560b7c4e53f42864f508483a6473b6a11079b2db
S = 1b766e9ceb71ba6c01dcd46e0af462cd4cfa652ae5017d4555b8eeefe36e1932
```

Figure 81. New Set of NIST ECC Test Vectors

Follow the procedure below to wrap the new ECC public key using the KUK file generated in Figure 73.

From the SKMT GUI, make sure **RA Family**, **SCE9 Security Functions**, and **Protected Mode** are selected from the **Overview** page. Next, navigate to the **Wrap Key** page. Select the **Key Type** as **secp256r1**, **public** as shown in Figure 70.

Under the **Key Data** area, select **Raw** and provide **Qx** and **Qy** as shown below. The key data is duplicated here so the user can copy and paste it to the GUI interface.

Qx = e266ddfdc12668db30d4ca3e8f7749432c416044f2d2b8c10bf3d4012aeffa8a

Qy = bfa86404a2e9ffe67d47c587ef7a97a7f456b863b4d02cfc6928973ab5b1cb39

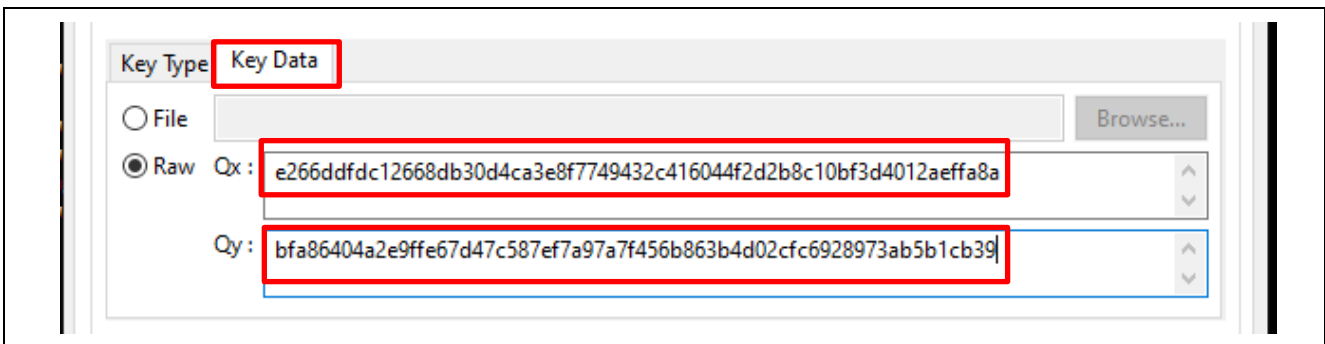

Figure 82. Provide the New ECC Public Key Data

Next, under the **Wrapping Key** section, click the corresponding **Browse** button to select the KUK generated in section 5.1.1.2. For the **IV**, select **Generate random value**. In the **Output** option, choose **C Source** and name the output as `new_ecc_public_key.c`. set the **Key name** to `NEW_ECC_PUB`.

Finally, click **Generate file**. Both the `new_ecc_public_key.c` and the `new_ecc_public_key.h` files will be generated.

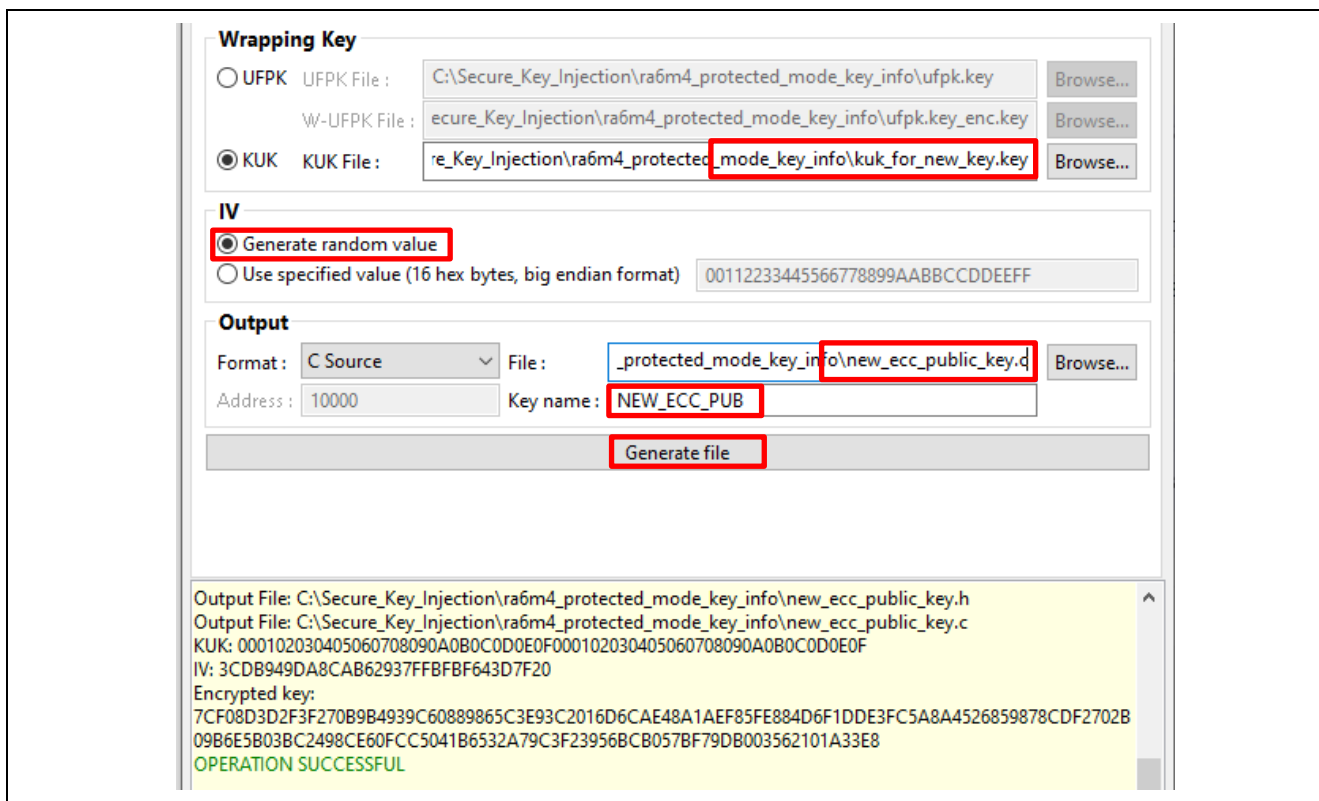

Figure 83. Generate KUK-Wrapped ECC Public Key

5.1.2 Using the SKMT CLI Interface

This section describes how to perform the actions described above using the SKMT CLI interface. These examples use SCE9 Protected mode, but SCE7 support is fundamentally the same.

The `/genkey` command of the Security Key Management Tool command line tool `skmt.exe` will be used to prepare keys for secure injection and update. These are the options for this command:

- `/keytype` – This input can take either ASCII or a one-byte hexadecimal input parameter indicating the key type.
- `/ufpk` – The User Factory Programming Key.
- `/wufpk` – The Renesas HRK-wrapped UFPK.
- `/kuk` – The Key-Update Key for secure key update.
- `/mcu` – The target MCU and security engine.
- `/output` – The output of the command.

Refer to the Security Key Management Tool user’s manual for more information about these commands, including the valid values for each parameter.

This application project uses an AES-256 key and an ECC secp256r1 public key to illustrate the secure key injection and update processes.

For these examples, we will use the UFPK and W-UPFK created earlier.

5.1.2.1 Wrap an Initial AES-256 Key with the UFPK

In the Command Prompt window opened earlier (section 4.3), use the following command to create the AES-256 key injection file (AES256_CLI.rkey). Refer to the Security Key Management Tool user manual for more information on how to construct the command.

```
Skmt.exe /genkey /ufpk
file="C:\Secure_Key_Injection\ra6m4_protected_mode_key_info\ufpk.key" /wufpk
file="C:\Secure_Key_Injection\ra6m4_protected_mode_key_info\ufpk.key_enc.key"
/mcu "RA-SCE9" /keytype "AES-256" /key
"8000000000000000000000000000000000000000000000000000000000000000" /filetype
"rfp" /output
"C:\Secure_Key_Injection\ra6m4_protected_mode_key_info\AES256_CLI.rkey"
```

Note that in this example:

- We are using 8000 from the NIST vector in Figure 64 as the AES-256 plaintext user key.
- We have specified the key type "AES-256".
- "RA-SCE9" is used for the /mcu option.
- We are using a randomly generated IV. The IV changes each time this command is executed.
- In this example, we have specified the complete file path for the key file AES256_CLI.rkey.

```
Output File:C:\Secure_Key_Injection\ra6m4_protected_mode_key_info\AES256_CLI.rkey
UFPK: 000102030405060708090A0B0C0D0E0F000102030405060708090A0B0C0D0E0F
W-UFPK: 000000006FEE15036A3B4E726F0B3F9E1F74B7076FEE15036A3B4E726F0B3F9E1F74B707
IV: 0B730F4F7194A9CB67E284A1B0D2A370
Encrypted key:
1D6612F7F276BFBEBE05410151C43E74E0368D3FB0688FB7A5D2D35E2B286A9963C14F3FE16A4529AAC7E8B0650EB72
```

Figure 84. Create the AES-256 User Key Injection File

The generated key file AES256_CLI.rkey now contains the encrypted user key along with the W-UFPK. The plaintext AES-256 key and UFPK are NOT contained in the *.rkey file, enabling confidential transfer of the key injection file contents.

5.1.2.2 Wrap an Initial ECC Public Key with the UFPK

In this section, we will use the ECC key pair in Figure 69 as an example of preparing an ECC public key for secure key injection.

In the Command Prompt window opened earlier (section 4.3), use the following command to create the ECC public key injection file (ECC_Public_Key_CLI.rkey). Refer to the Security Key Management Tool user manual for more information on how to construct the command.

```
Skmt.exe /genkey /ufpk
file="C:\Secure_Key_Injection\ra6m4_protected_mode_key_info\ufpk.key" /wufpk
file="C:\Secure_Key_Injection\ra6m4_protected_mode_key_info\ufpk.key_enc.key"
/mcu "RA-SCE9" /keytype "secp256r1-public" /key
"1ccbe91c075fc7f4f033bfa248db8fccd3565de94bbfb12f3c59ff46c271bf83
ce4014c68811f9a21a1fdb2c0e6113e06db7ca93b7404e78dc7ccd5ca89a4ca9" /filetype
"rfp" /output
"C:\Secure_Key_Injection\ra6m4_protected_mode_key_info\ECC_Public_Key_CLI.rkey
"
```

Note that in this example:

- 1ccbe91c075fc7f4f033bfa248db8fccd3565de94bbfb12f3c59ff46c271bf83 ce4014c68811f9a21a1fdb2c0e6113e06db7ca93b7404e78dc7ccd5ca89a4ca9 is the NIST ECC public key from Figure 69 .
- We have specified the key type "secp256r1-public".
- "RA-SCE9" is used for the /mcu option.

- We are using a randomly generated IV. The IV is updated in each encryption instance.
- The command option `/output` defines the locations and name of the output file.

```
Output File: C:\Secure_Key_Injection\ra6m4_protected_mode_key_info\ECC_Public_Key_CLI.rkey
UFPK: 000102030405060708090A0B0C0D0E0F000102030405060708090A0B0C0D0E0F
W-UFPK: 1234567890ABCDEF1234567890ABCDEF1234567890ABCDEF1234567890ABCDEF12345678
IV: 0273B7277508F33491F2BA569B092535
Encrypted key:
1234567890ABCDEF1234567890ABCDEF1234567890ABCDEF1234567890ABCDEF1234567890ABCDEF1234
567890ABCDEF1234567890ABCDEF1234567890ABCDEF1234567890ABCDEF
```

Figure 85. Create the ECC Public Key Injection File Using CLI

5.1.2.3 Create and Wrap a Key-Update Key with the UFPK

We can use the SKMT to create a key file for a KUK. This is done with the following command:

```
skmt.exe /genkuk /kuk
"000102030405060708090A0B0C0D0E0F000102030405060708090a0b0c0d0e0f" /output
"C:\Secure_Key_Injection\ra6m4_protected_mode_key_info\kuk_for_new_key_cli.key
"
```

Note that in this example:

- We have specified the complete file path for the key file.
- We need to use the same Key-Update Key as used in section 5.1.2.3 .

```
KUK: 000102030405060708090A0B0C0D0E0F000102030405060708090A0B0C0D0E0F
Output File:
C:\Secure_Key_Injection\ra6m4_protected_mode_key_info\kuk_for_new_key_cli.key
```

Figure 86. Create the KUK Key File

The generated key file `kuk_for_new_key_cli.key` now contains the KUK. Retain this key file to use for wrapping new user keys for secure key updates.

To enable secure key updates, we must first securely inject the KUK. Use the SKMT to wrap the KUK with the UFPK and create a key injection file for use with RFP with the following command:

```
skmt.exe /genkey /ufpk
file="C:\Secure_Key_Injection\ra6m4_protected_mode_key_info\ufpk.key" /wufpk
file="C:\Secure_Key_Injection\ra6m4_protected_mode_key_info\ufpk.key_enc.key"
/mcu "RA-SCE9" /keytype "key-update-key" /key
file="C:\Secure_Key_Injection\ra6m4_protected_mode_key_info\kuk_for_new_key_cl
i.key" /filetype "rfp" /output
"C:\Secure_Key_Injection\ra6m4_protected_mode_key_info\KUK_CLI.rkey"
```

Note that in this example:

- We are using the KUK key file created above.
- We have specified the key type "key-update-key".
- We are using a randomly generated IV. The IV changes each time this command is executed.
- In this example, we have specified a complete file path for the key file (`KUK_CLI.rkey`).

```
Output File: C:\Secure_Key_Injection\ra6m4_protected_mode_key_info\KUK_CLI.rkey
UFPK: 000102030405060708090A0B0C0D0E0F000102030405060708090A0B0C0D0E0F
W-UFPK: 1234567890ABCDEF1234567890ABCDEF1234567890ABCDEF1234567890ABCDEF12345678
IV: 1234567890ABCDEF1234567890ABCDEF
Encrypted key:
1234567890ABCDEF1234567890ABCDEF1234567890ABCDEF1234567890ABCDEF1234567890ABCDEF
```

Figure 87. Create the Key-Update Key Injection File Using CLI

The generated key file `KUK_CLI.rkey` now contains the wrapped KUK along with the W-UFPK. The plaintext KUK and UFPK are NOT contained in the `*.rkey` file, enabling confidential transfer of the key injection file contents.

5.1.2.4 Wrap a New AES-256 Key with the KUK

The user can use the following command to wrap the new AES key defined in Figure 77 using the KUK. This is done with the following command.

```
C:\Renesas\SecurityKeyManagementTool\cli>skmt.exe /genkey /kuk
file="C:\Secure_Key_Injection\ra6m4_protected_mode_key_info\kuk_for_new_key_cli.
key" /mcu "RA-SCE9" /keytype "AES-256" /key
"c0000000000000000000000000000000000000000000000000000000000000000000" /filetype
"csource" /keyname "NEW_AES256" /output
"C:\Secure_Key_Injection\ra6m4_protected_mode_key_info\new_aes_key_cli.c"
```

Note that in this example:

- We are using `c000` as the new AES-256 plaintext key.
- We are using a randomly generated IV. The IV changes each time this command is executed.
- We use the `/keyname` to create an identifiable key structure name that is unique in the software project. This resolves confusions when more than one set of new user keys are to be generated. If this option is not provided, a key structure name of `encrypted_user_key_data` is generated for the key structure.
- The generated `new_aes_key_cli.c` and `new_aes_key_cli.h` files include the output information in a data structure. The user can directly include these two files in the application project. This is demonstrated in the example project included.

```
Output File: C:\Secure_Key_Injection\ra6m4_protected_mode_key_info\new_aes_key_cli.h
Output File: C:\Secure_Key_Injection\ra6m4_protected_mode_key_info\new_aes_key_cli.c
KUK: 000102030405060708090A0B0C0D0E0F000102030405060708090A0B0C0D0E0F
IV: 3C8841F6E6AE05B7625098EC70C542C1
Encrypted key:
03FE218ABCD0AD2F5A5634833ABD7F4D6F4CF8BF2CAC737CE1BE56C28DF0ADAD52536EED8DF405031230F935B087ECA0
```

Figure 88. Encrypt the New User Key with the KUK

5.1.2.5 Wrap a New ECC Public Key With the KUK

Use the following command to wrap the new ECC public key shown in Figure 81.

```
skmt.exe /genkey /kuk
file="C:\Secure_Key_Injection\ra6m4_protected_mode_key_info\kuk_for_new_key.ke
y" /mcu "RA-SCE9" /keytype "secp256r1-public" /key
"e266ddfdcd12668db30d4ca3e8f7749432c416044f2d2b8c10bf3d4012aeffa8abfa86404a2e9f
fe67d47c587ef7a97a7f456b863b4d02cfc6928973ab5b1cb39" /filetype "csource"
/keyname "NEW_ECC_PUB" /output
"C:\Secure_Key_Injection\ra6m4_protected_mode_key_info\new_ecc_public_key_cli.
c"
```

Note that in this example:

- `e266ddfdcd12668db30d4ca3e8f7749432c416044f2d2b8c10bf3d4012aeffa8abfa86404a2e9ffe67d47c587ef7a97a7f456b863b4d02cfc6928973ab5b1cb39` is the ECC public key from the NIST test vector shown in Figure 81.
- The key type "secp256r1-public" is one of the available options specified in the Security Key Management Tool user's manual.
- "RA-SCE9" is used for the `/mcu` option.
- We are using a randomly generated IV. The IV changes each time this command is executed.
- The command option `/output` defines the locations and name of the output file.

- We use the `/keyname` to create an identifiable key structure name that is unique in the software project. This resolves confusions when more than one set of new user keys are to be generated. If this option is not provided, a key structure named `encrypted_user_key_data` is generated for the key structure.
- The generated `new_ecc_public_key_cli.c` and `new_ecc_public_key_cli.h` files include the output information in a data structure. This is demonstrated in the example project included.

```
Output File: C:\Secure_Key_Injection\ra6m4_protected_mode_key_info\new_ecc_public_key_cli.h
Output File: C:\Secure_Key_Injection\ra6m4_protected_mode_key_info\new_ecc_public_key_cli.c
KUK: 000102030405060708090A0B0C0D0E0F000102030405060708090A0B0C0D0E0F
IV: 36E763D5A82924B4888732D50C93B602
Encrypted key:
9B0A7F8C91C038704A4F2C758EAC3DDD1372B4DC6AA4F22667D7D0E41218A1DEDBB8337E557B59B91100225BC8BBE2807221
4FF3C729D953AEFA9E997C3989967C831DC6501E9528715ADA30FA0D0402
```

Figure 89. Encrypt the New ECC Public Key with the KUK

5.2 Secure Key Injection via MCU Boot Interface

Follow this section to inject the AES-256 key, the ECC public key, and the Key-Update Key (KUK) that were prepared in section 5.1.1 or section 5.1.2. This capability is supported by RA Family MCUs that incorporate the SCE9 (Protected Mode) or SCE5_B security engine.

5.2.1 Setting up the Hardware

Set up the EK-RA6M4 evaluation board as follows.

- Connect the jumper setting to J16 to put the device in boot mode. Refer to the EK-RA6M4 User's Manual for details.
- Connect the EK-RA6M4 J10 connector to the development PC using a USB micro-B cable to provide power and a debug connection using the onboard debugger.

Erase the entire MCU flash and ensure that the MCU is in the SSD Device Lifecycle State. This can be done using the Renesas Flash Programmer, as shown here.

1. Unzip `rfp_resources_ra6m4.zip`
2. Launch the Renesas Flash Programmer GUI executable.
3. Select **File > Open Project** and select `ra6m4_secure_key_inject.rpj`.
4. Select **Target Device -> Initialize Device**.

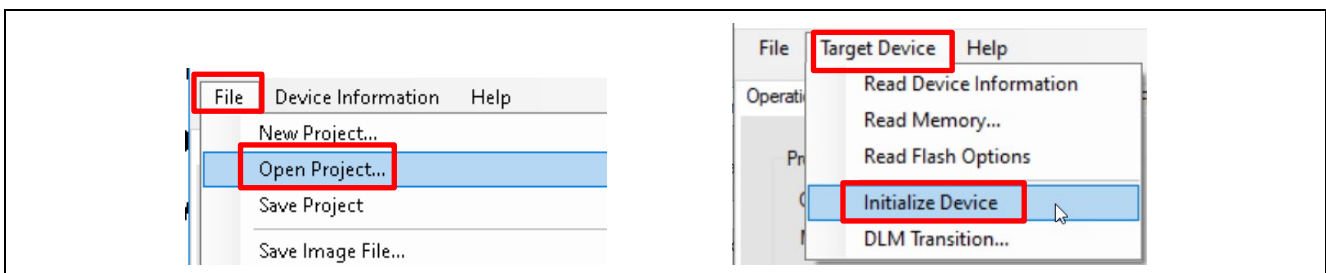

Figure 90. Open RFP Project and Initialize the Device

Upon successful initialization, the following message will be printed.

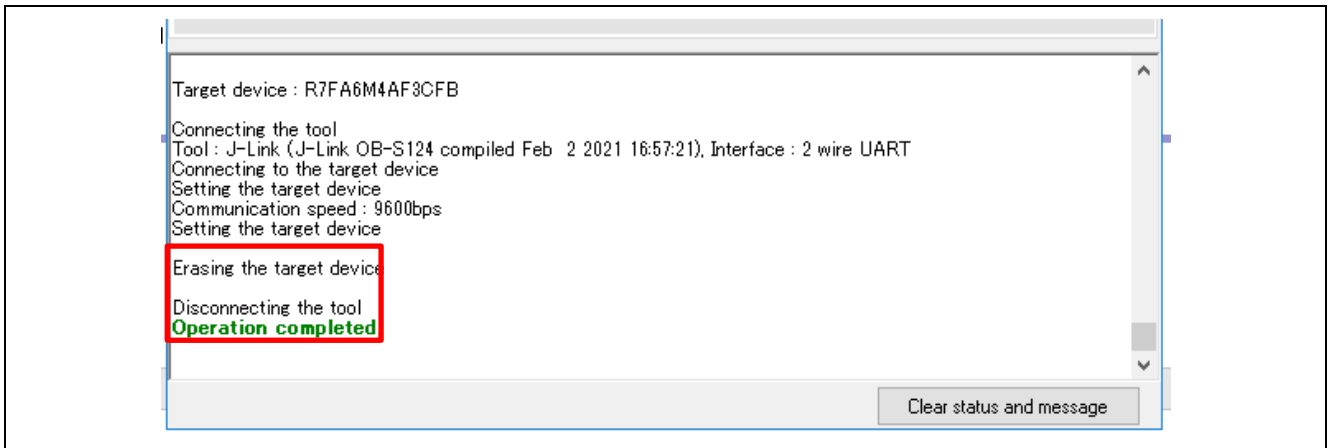

Figure 91. RA6M4 Initialization

Unless there are permanently locked flash blocks, the entire flash will be erased, and the RA6M4 will be set to SSD state through the above steps.

5.2.2 Inject the Initial User Key and Key-Update Key

After initializing the RA6M4, power-cycle the board and follow the steps below to inject the AES-256 key, the ECC public key, and the Key-Update Key. This section uses the set of injection keys generated from the GUI interface.

To simplify duplicating this example, the `.rkey` files that match the example project are included in the `rfp_resources_ra6m4.zip` file. If the user intends to use the NIST vectors included in this application project for verification purposes, they can use the included `.rkey` files for system verification. The screen captures included in this section use these files for demonstration purposes. If different keys are used, then the corresponding `.rkey` files must be updated to match those keys.

Under the **Operation** tab, click **Add/Remove Files**. Next, click **Add Files**, and then add the `.rkey` file containing the AES256 key, which for this example is `\rfp_resources_ra6m4\user_keys\AES256.rkey` (Figure 67). Set the **Address** property to a data flash or code flash address applicable to your specific application. In this example, the AES key will be injected into the first block of Data Flash at `0x08000000`.

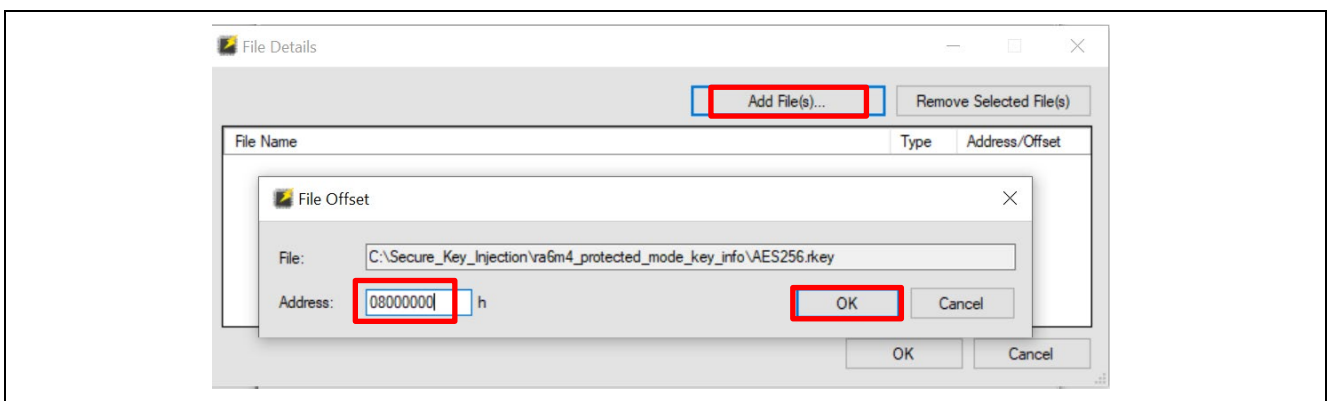

Figure 92. Add the AES256.rkey to RFP Configuration

Click **OK**, the AES256.rkey file will be configured to the corresponding load address.

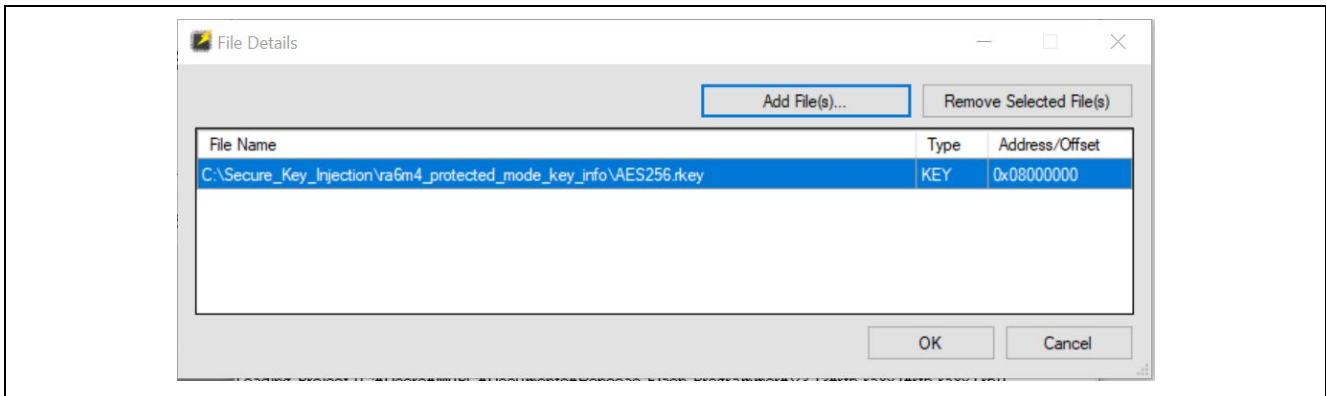

Figure 93. AES256.rkey is added to the RFP Configuration

Click **Add Files** again and add `ECC_Public_Key.rkey`. Browse to the `ECC_Public_Key.rkey` (Figure 72). Set the **Address** property to a data flash or code flash address applicable to your specific application. In this example, the ECC public key will be injected into the third block of Data Flash at 0x08000080.

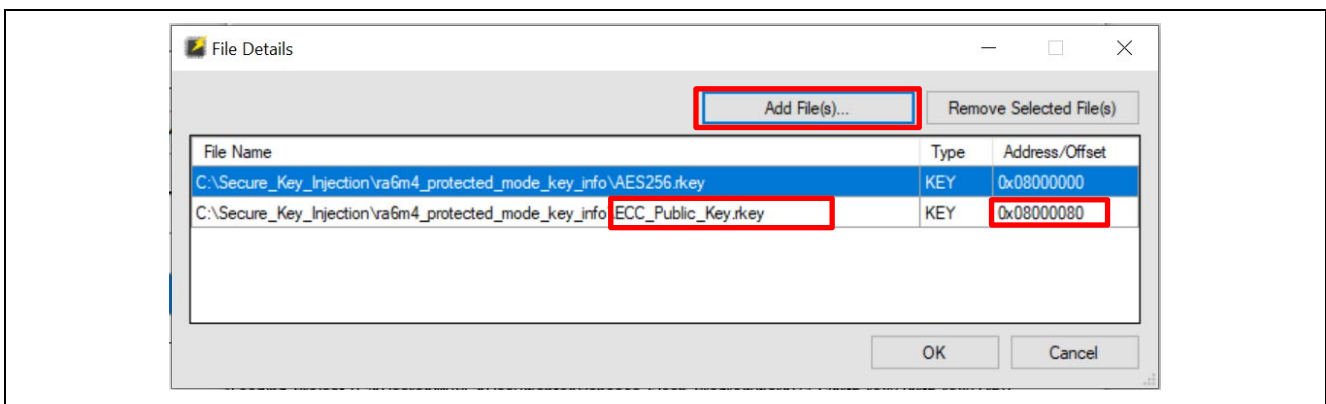

Figure 94. Configure the ECC Public Key Selection and Injection Address

Click **Add Files** again and add `KUK.rkey`. Browse to the `KUK.rkey` (Figure 76). Set the **Address** property to a data flash or code flash address applicable to your specific application. In this example, the Key-Update Key will be injected into the code flash at 0x00040000.

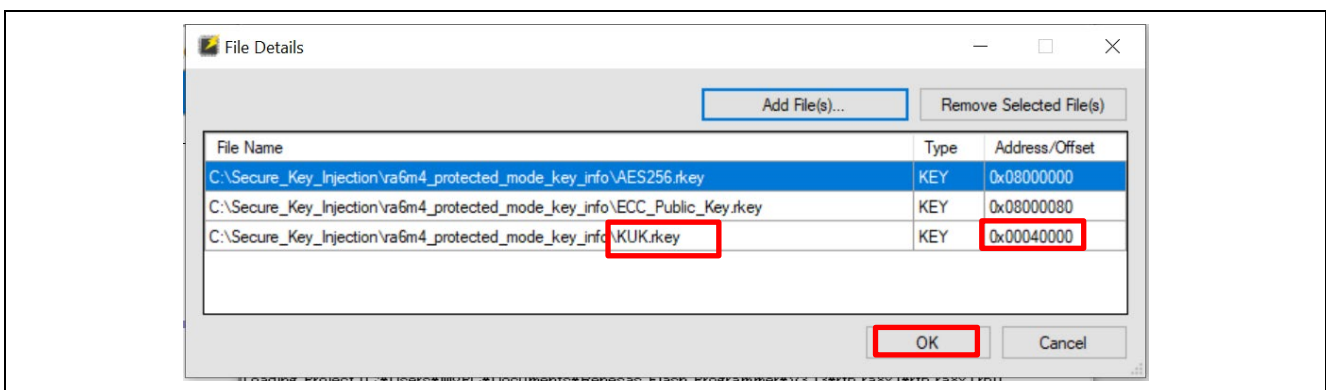

Figure 95. Configure the Key-Update Key Selection and Injection Address

Click **OK** and navigate to the **Operation Settings**. Note that **Erase**, **Program**, **Verify**, and **Erase Before Program** are selected.

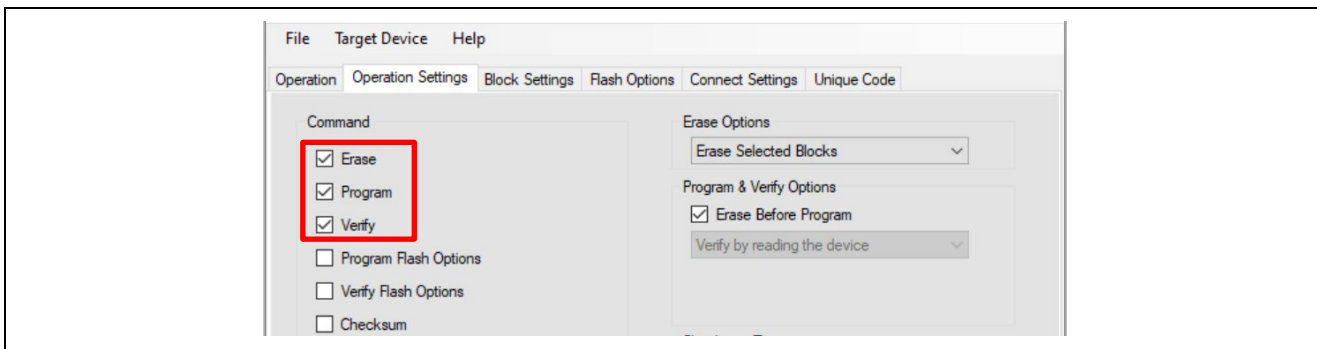

Figure 96. Select to Perform Flash Erase, Program, and Verify

- Browse to the **Block Settings** tab and note that the entire flash region is selected for Erase.

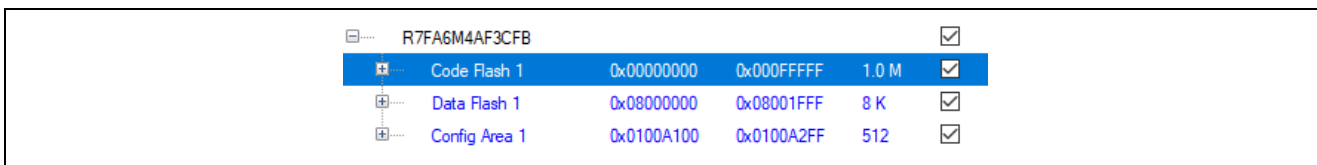

Figure 97. Entire Flash Region is Selected for Erase

- Browse to the **Operation** tab. Click **Start** to inject the AES-256, the ECC public key, and the Key-Update Key. The injection should succeed with a similar output message as shown below at the selected flash addresses.

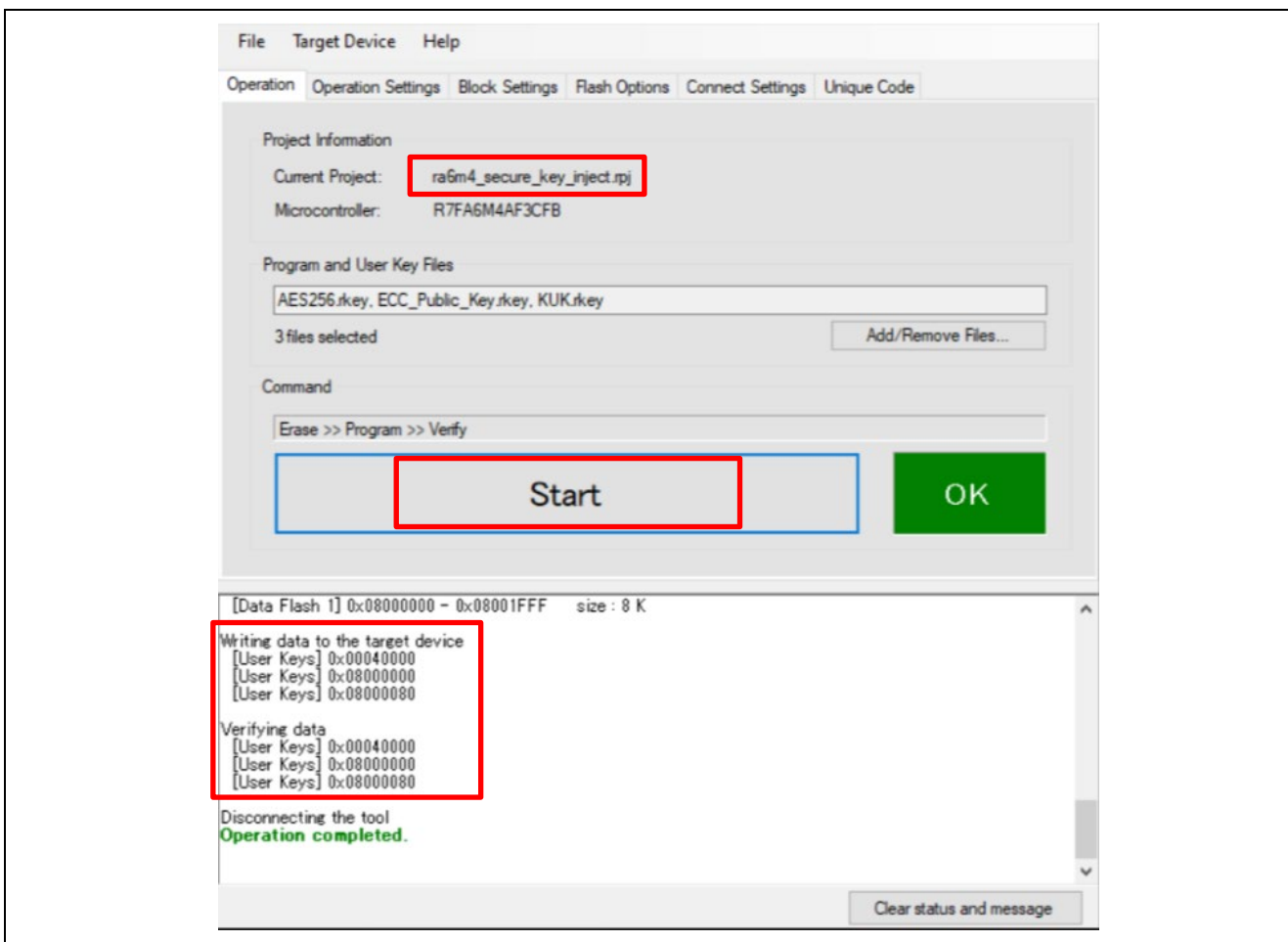

Figure 98. Secure Keys Successfully Injected

In this example code, no application is programmed since we are interested only in the key injection. In a production flow, it is possible to program the application and user keys together. This operation can also be performed using the command line function of RFP.

6. Secure Key Injection Preparation for RSIP and SCE7 Compatibility Mode

This section shows how to generate the .c and .h files, which can be used in an application project that uses the FSP APIs to inject keys into the PSA Crypto APIs using the security engine in Compatibility Mode. This key injection method must be used for both user keys and Key-Update Keys.

6.1 Wrap an AES-128 User Key Using the UFPK for RSIP-E51A Compatibility Mode

A NIST CAVP test vector is used for the demonstration.

<https://csrc.nist.gov/Projects/Cryptographic-Algorithm-Validation-Program/Block-Ciphers>

```
KEY = e0000000000000000000000000000000
IV = 00000000000000000000000000000000
PLAINTEXT = 00000000000000000000000000000000
CIPHERTEXT = 72a1da770f5d7ac4c9ef94d822affd97
```

Figure 99. NIST AES-128 Test Vector

Using the SKMT GUI interface, on the **Overview** tab, select **RA Family, RSIP-E51A Compatibility Mode**.

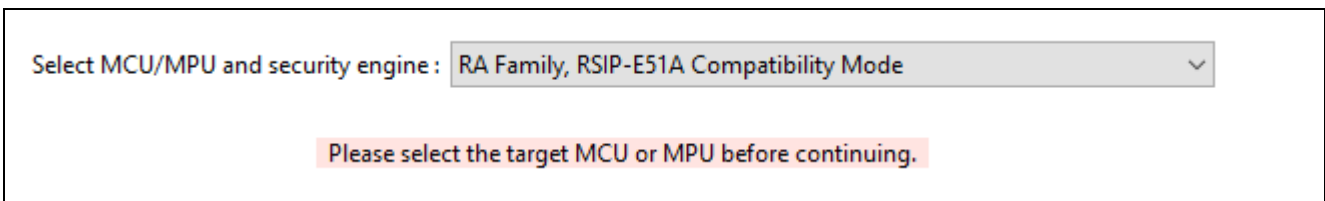

Figure 100. Choose RA Family, RSIP-E51A Compatibility Mode

On the **Wrap Key** tab, in the **Key Type** area, choose **AES** and **128 bits**.

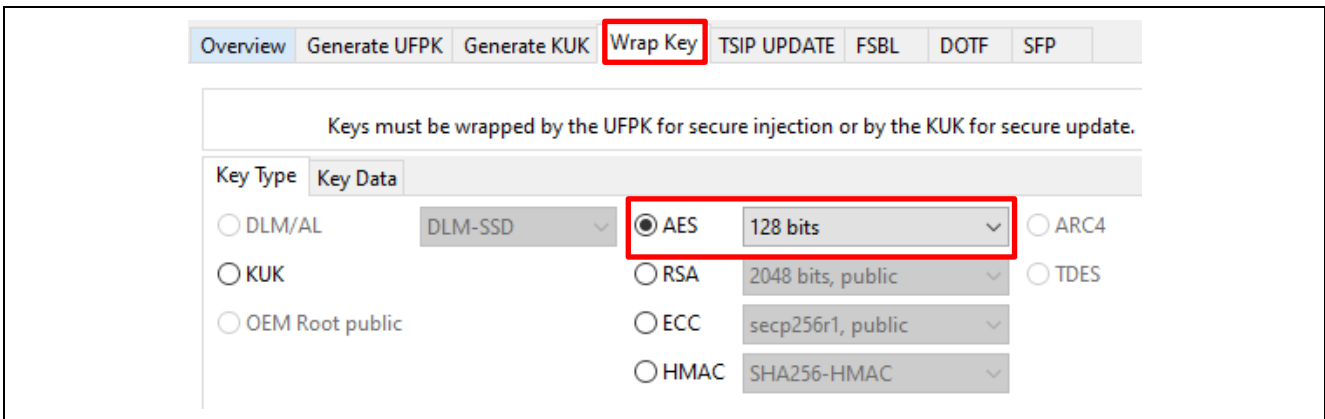

Figure 101. Choose AES-128 bits as the Key Type

Select the **Key Data** tab and input the **Raw** Key Data as shown below based on the NIST vector as shown in Figure 99.

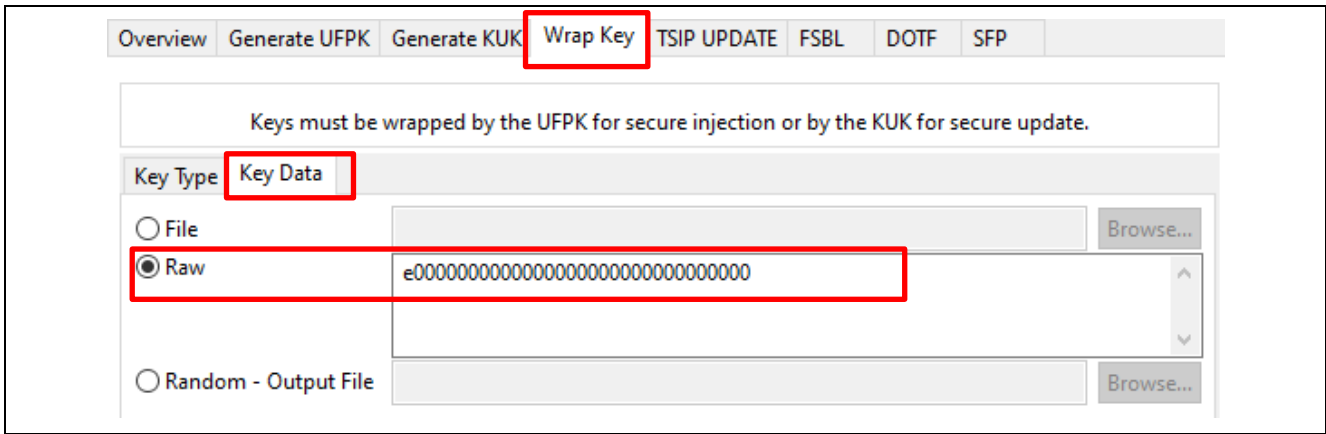

Figure 102. Set up the Initial AES-128 Key Data

Under the **Wrapping Key** section, click the corresponding **Browse** buttons to select the **UFPK** and **W-UFPK** key pair. Choose the **Generate random value** option for the **IV** data. For the **Output** option, select **C Source**; then click the **Browse** button, choose the output folder and file name, and name the key. This name will be reflected in the definitions generated for the C source files.

Now click the **Generate File** button. The source files to inject the AES key will be generated.

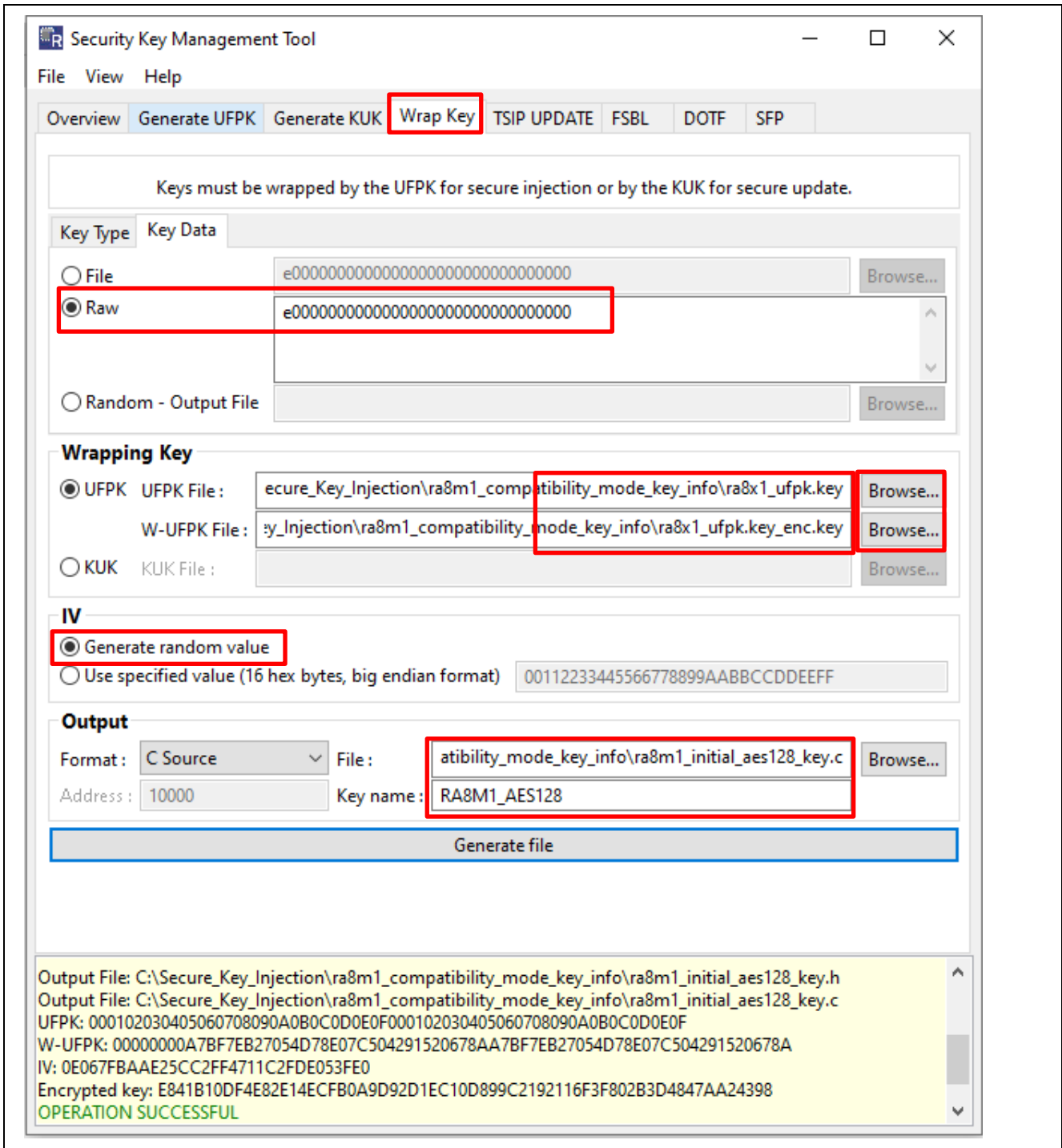

Figure 103. Generate the Initial AES-128 Encrypted Key File

Note that the generated `ra8m1_initial_aes_128.c` and `ra8m1_initial_aes_128.h` are used in the RA8M1 secure key injection example project.

6.2 Wrap an AES-128 User Key Using the UFPK for SCE7

The same NIST CAVP test vector is shown in Figure 99 is used for the demonstration.

Using the SKMT GUI interface, on the **Overview** tab, select **RA Family, SCE7**. On the **Wrap Key** tab, in the **Key Type** area, choose **AES** and **128 bits**.

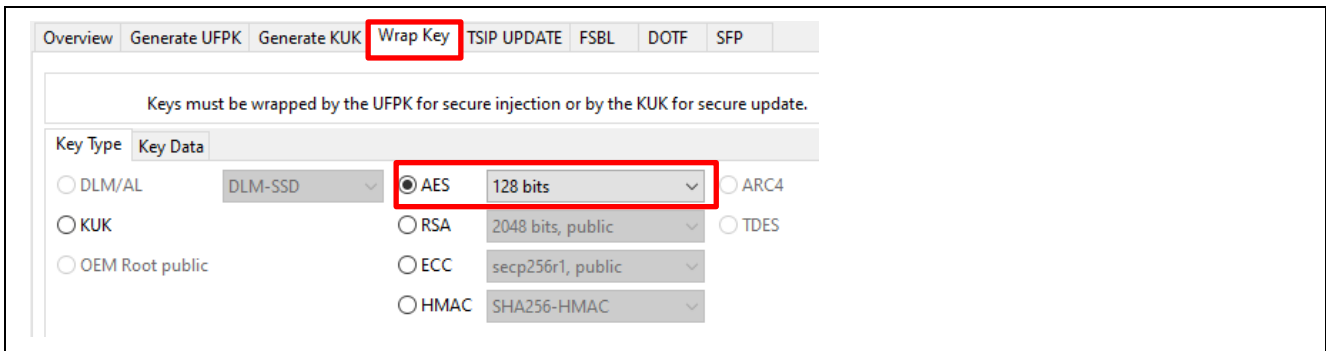

Figure 104. Choose AES-128 bits as the Key Type

Select the **Key Data** tab and input the **Raw** Key Data as shown below based on the NIST vector as shown in Figure 103.

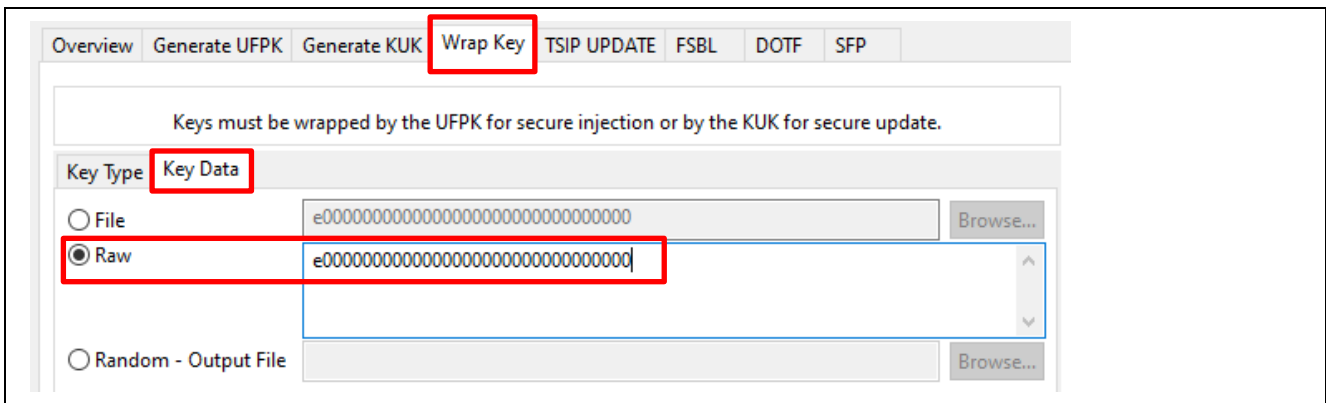

Figure 105. Set up the AES-128 Key Data

Under the **Wrapping Key** section, click the corresponding **Browse** buttons to select the **UFPK** and **W-UFPK** key pair for RA6M3. Choose the **Generate random value** option for the **IV** data. For the **Output** option, select **C Source**; then click the **Browse** button, choose the output folder and file name, and name the key. This name will be reflected in the definitions generated for the C source files.

Now click the **Generate File** button. The source files to inject the AES key will be generated.

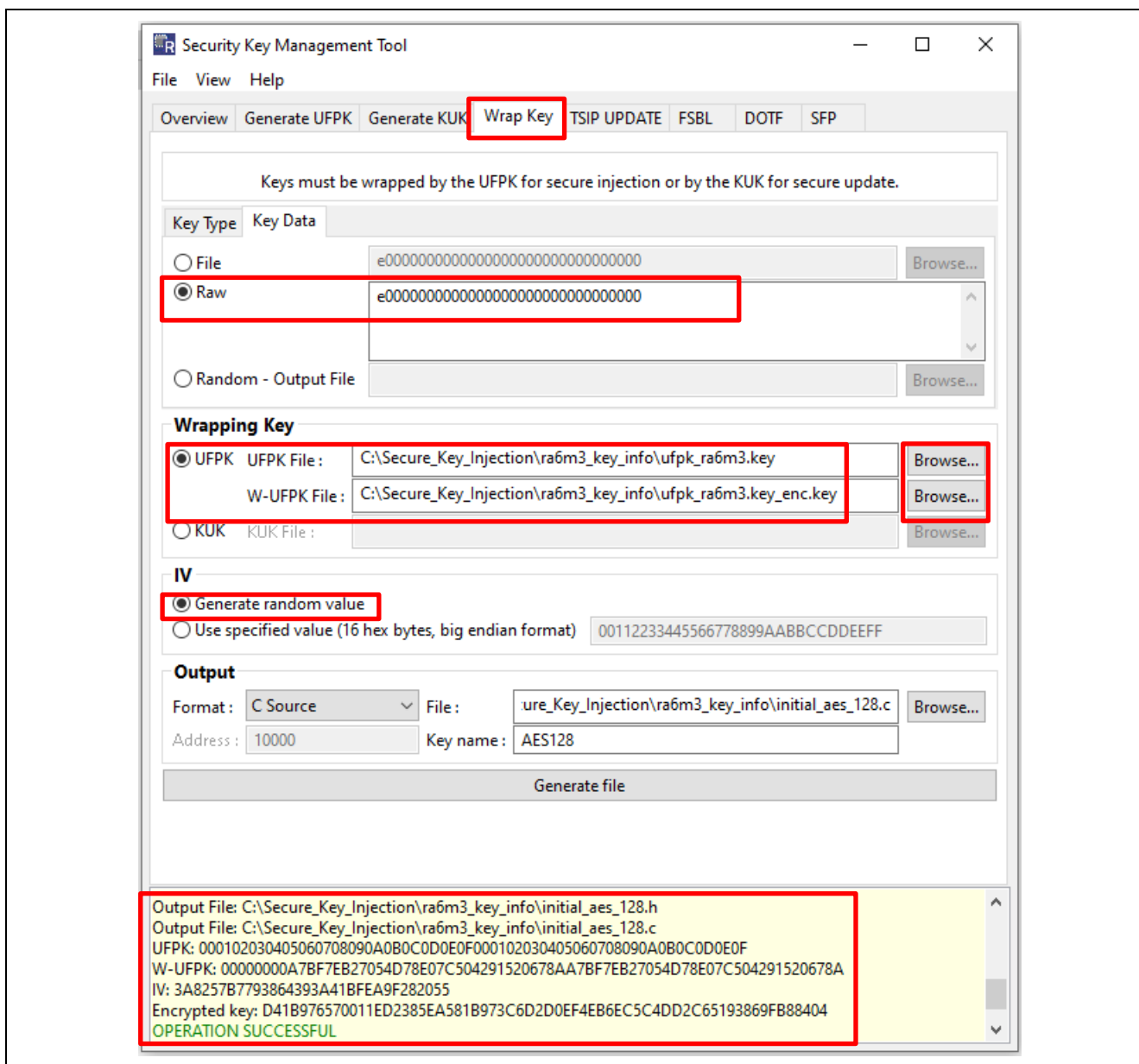

Figure 106. Generate the AES-128 Encrypted Key File

7. Example Project for RA6M4 (SCE9 Protected Mode)

To exercise the example projects as is, users can follow the steps below:

- Inject the included example RFP injection keys (AES256.rkey, KUK.rkey, and ECC_Public_Key.rkey which are included in rfp_resource_ra6m4.zip) by following section 5.2.2.
- A set of new user keys (AES256 as well as ECC Public Key) generated using the example KUK is already provisioned in the example projects. The user can then directly proceed to exercise the example project.
- **Please do not use the example keys for production support.**

To use the example projects with customized keys, the user can follow below steps:

- To test customized RFP injection keys and new user update keys (generated by the following section 5.1.1 or 5.1.2 rather than using the ones included in `rfp_resources_ra6m4.zip`), the user needs to follow section 5.2.2 to inject the keys to the MCU. User also needs to generate customized new user key files (`new_aes_key.c/.h` and `new_ecc_public_key.c/.h`) with the same key name to replace the corresponding files used in the example project. Once the example projects are updated, the user can proceed to run the example projects to verify the operations.
- To test the new user key update procedure only, the user can use the included RFP `KUK.rkey` file to generate new source files to replace the corresponding files in the example project. Once the example projects are updated, the user can then proceed to the verification of the operations.

7.1 Example Project Overview

This pair of TrustZone-based secure and non-secure example projects provides the following functions:

Secure project (`secure_key_inject_update_ra6m4_s`):

- Uses the injected AES-256 key to perform cryptographic operation using AES256-CBC.
- The injected Key-Update Key (KUK) is used to inject the new AES-256 key and store this new AES-256 key for data flash.
- Uses the new AES-256 to perform cryptographic operation using AES256-CBC.
- Uses the injected ECC public key to verify the NIST test signature shown in Figure 69.
- The injected Key-Update Key (KUK) is used to inject the newly wrapped ECC public key and store this new ECC public key for data flash.
- Uses the new ECC public key to verify the NIST test signature shown in Figure 81.

Non-secure project (`secure_key_inject_update_ra6m4_ns`):

- Establishes an RTT Viewer interface to allow users to select the intended Secure Crypto Engine and flash operation.
- Calls the non-secure callable APIs provided from the secure project based on user selection from the RTT Viewer interface.
- Prints the user operation results on the RTT Viewer.

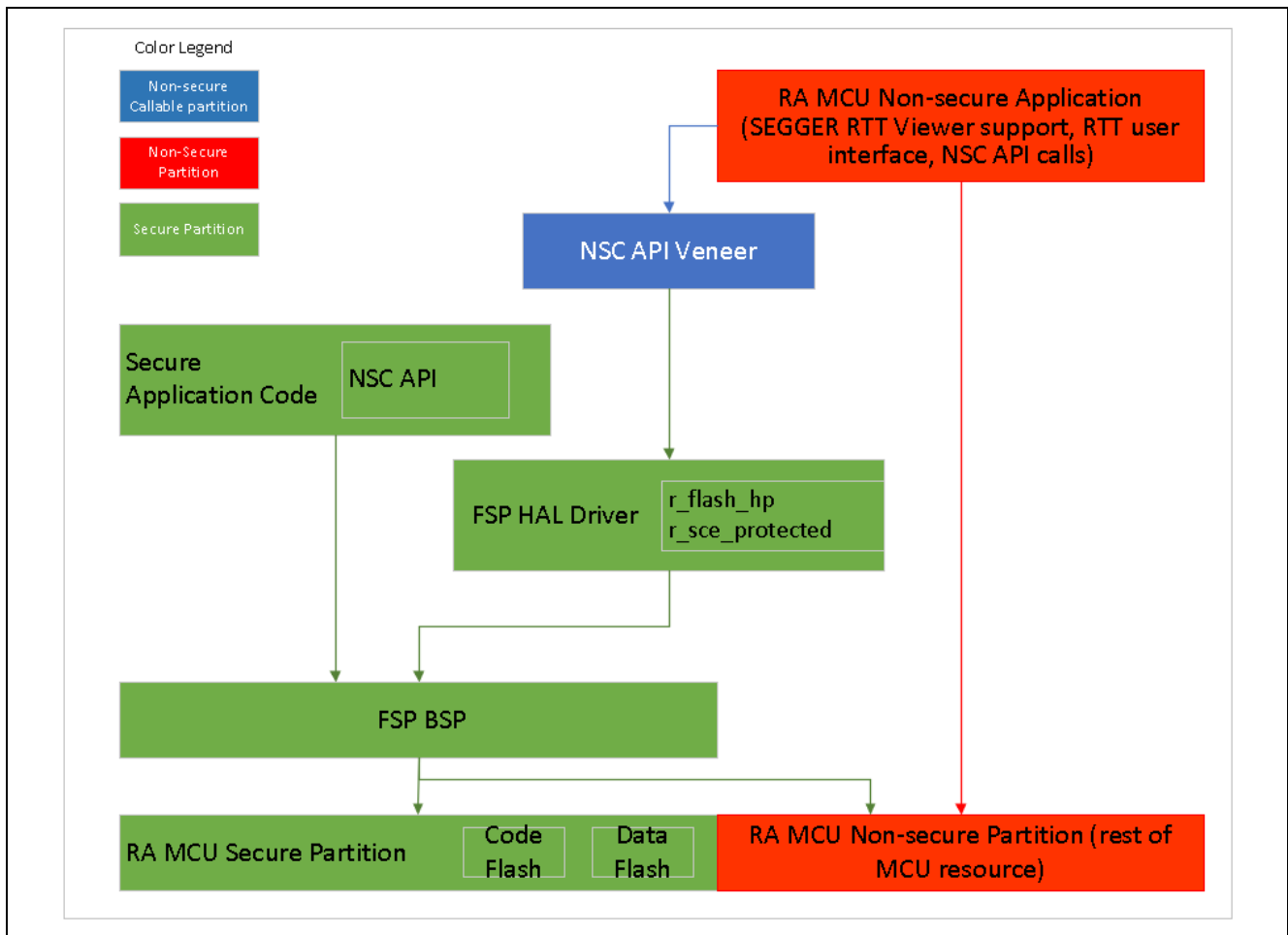

Figure 107. Software Block Diagram

The FSP modules used in this pair of example projects are:

- `r_sce_protected`: This module is used in the secure region and provides services to the non-secure region via non-secure callable APIs
- `r_flash_hp`: This module is used in the secure region and provides services to the non-secure region via non-secure callable APIs

For more information on designing applications with TrustZone® support, refer to the application project *Renesas RA Family MCU Security Design with TrustZone – IP Protection*.

7.2 Using the RFP Injected Keys

7.2.1 Formatting the Injected Keys

The keys that are injected into the MCU flash using RFP cannot be used directly by the FSP Crypto APIs. A minor formatting change is required.

7.2.1.1 Formatting the Injected AES Key

The following code snippet reads the AES-256 key from Flash. The destination buffer can then be used for cryptographic operations. Replace the macro `DIRECT_AES_KEY_ADDRESS` with the actual injection address.

```
static sce_aes_wrapped_key_t injected_key;
injected_key.type = SCE_KEY_INDEX_TYPE_AES256;
memcpy(injected_key.value, (uint32_t *)DIRECT_AES_KEY_ADDRESS,
        HW_SCE_AES256_KEY_INDEX_WORD_SIZE*4);
```

7.2.1.2 Formatting the Injected ECC Public Key

The following code snippet reads the ECC public key from Flash. The destination buffer can then be used for cryptographic operations. Replace the macro `DIRECT_ECC_PUB_KEY_ADDRESS` with the actual injection address.

```
static sce_ecc_public_wrapped_key_t ecc_public_key_injected;
ecc_public_key_injected.type = SCE_KEY_INDEX_TYPE_ECC_P256_PUBLIC;
wrapped_ecc_public_key_size = sizeof(ecc_public_key_injected.value);
memcpy((uint8_t *)(&(ecc_public_key_injected.value)), (uint8_t *)DIRECT_ECC_PUB_KEY_ADDRESS,
        wrapped_ecc_public_key_size);
```

7.2.1.3 Formatting the Injected KUK

The following code snippet reads the injected KUK from the flash. The destination buffer can then be used for secure key updates. Replace the macro `KUK_ADDRESS` with the actual injection address.

```
static sce_key_update_key_t kuk_key;
kuk_key.type = SCE_KEY_INDEX_TYPE_UPDATE_KEY_RING;
memcpy(kuk_key.value, (uint32_t *) (KUK_ADDRESS), HW_SCE_UPDATE_KEY_RING_INDEX_WORD_SIZE*4);
```

7.2.1.4 Formatting an Injected RSA Public Key

This application project does not include an example usage for RSA secure key injection and update, but the principles are identical. The following code snippet can be used to format an injected RSA public key. Replace the macro `RSA_2048_PUB_KEY_ADDRESS` with the actual injection address

```
static sce_rsa2048_public_wrapped_key_t injected_rsa_public_key;
injected_rsa_public_key.type = SCE_KEY_INDEX_TYPE_RSA2048_PUBLIC;
uint32_t wrapped_rsa_2048_public_key_size = sizeof(injected_rsa_public_key.value);
memcpy((uint8_t *)(&(injected_rsa_public_key.balur)), (uint32_t *)RSA_2048_PUB_KEY_ADDRESS,
        wrapped_rsa_2048_public_key_size);
```

7.2.2 Verifying the Injected Key and the Updated Key

To verify the AES injection, provide the plaintext message and the expected cipher text for the injected AES key and the updated AES key to the software project. For example, based on the NIST vectors presented in Figure 64 and Figure 77, use the plaintext data below in `aes_crypto_operations.c`:

```
#define BLOCK    16
/* NIST vector plaintext message used for both directly injected AES key and updated AES key*/
static uint8_t plain_text[BLOCK] = {
    0x00, 0x00, 0x00, 0x00, 0x00, 0x00, 0x00, 0x00, 0x00, 0x00, 0x00, 0x00, 0x00, 0x00, 0x00, 0x00
};

/* NIST vector initialization vector for the directly injected AES key and the AES key update*/
static uint8_t iv[BLOCK] = {
    0x00, 0x00, 0x00, 0x00, 0x00, 0x00, 0x00, 0x00, 0x00, 0x00, 0x00, 0x00, 0x00, 0x00, 0x00, 0x00
};

/* NIST cipher to match directly injected AES key*/
static uint8_t cipher_expected[BLOCK] = {
    0xe3, 0x5a, 0x6d, 0xcb, 0x19, 0xb2, 0x01, 0xa0, 0x1e, 0xbc, 0xfa, 0x8a, 0xa2, 0x2b, 0x57, 0x59
};

/* NIST cipher to match new AES key */
static uint8_t cipher_expected_new[BLOCK] = {
    0xb2, 0x91, 0x69, 0xcd, 0xcf, 0x2d, 0x83, 0xe8, 0x38, 0x12, 0x5a, 0x12, 0xee, 0x6a, 0xa4, 0x00
};
```

To verify the ECC public key injection, the expected signature using the ECC private key, which matches the injected ECC public key (see Figure 69) is provided in the array `ECC_SECP256R1ExpectedSignature` in `ecc_crypto_operation.c`.

```
/* This is an externally generated NIST test signature using the private key */
uint8_t ECC_SECP256R1ExpectedSignature[] =
{
    0xf3, 0xac, 0x80, 0x61, 0xb5, 0x14, 0x79, 0x5b, 0x88, 0x43, 0xe3, 0xd6, 0x62, 0x95, 0x27, 0xed,
    0x2a, 0xfd, 0x6b, 0x1f, 0x6a, 0x55, 0x5a, 0x7a, 0xca, 0xbb, 0x5e, 0x6f, 0x79, 0xc8, 0xc2, 0xac,
    0x8b, 0xf7, 0x78, 0x19, 0xca, 0x05, 0xa6, 0xb2, 0x78, 0x6c, 0x76, 0x26, 0x2b, 0xf7, 0x37, 0x1c,
    0xef, 0x97, 0xb2, 0x18, 0xe9, 0x6f, 0x17, 0x5a, 0x3c, 0xcd, 0xda, 0x2a, 0xcc, 0x05, 0x89, 0x03
};
```

Figure 108. Provision the ECC_SECP256R1ExpectedSignature Array

Similarly, the expected signature using the ECC private key which matches the updated ECC public key (see Figure 81) is provided in the array `ECC_SECP256R1ExpectedSignature_New` in `ecc_crypto_operation.c`.

```
/* This is an externally generated signature using the private key */
uint8_t ECC_SECP256R1ExpectedSignature_New[] =
{
    0x97, 0x6d, 0x3a, 0x4e, 0x9d, 0x23, 0x32, 0x6d, 0xc0, 0xba, 0xa9, 0xfa, 0x56, 0x0b, 0x7c, 0x4e,
    0x53, 0xf4, 0x28, 0x64, 0xf5, 0x08, 0x48, 0x3a, 0x64, 0x73, 0xb6, 0xa1, 0x10, 0x79, 0xb2, 0xdb,
    0x1b, 0x76, 0x6e, 0x9c, 0xeb, 0x71, 0xba, 0x6c, 0x01, 0xdc, 0xd4, 0x6e, 0x0a, 0xf4, 0x62, 0xcd,
    0x4c, 0xfa, 0x65, 0x2a, 0xe5, 0x01, 0x7d, 0x45, 0x55, 0xb8, 0xee, 0xef, 0xe3, 0x6e, 0x19, 0x32
};
```

Figure 109. Provision the ECC_SECP256R1ExpectedSignature_New Array

There is no action needed from the user if the same sets of keys and plaintext messages are used. If new sets of keys and messages are used, the user needs to update the project with the new keys and messages.

7.3 FSP Crypto Module Support for User Key Update

This section introduces the FSP Crypto APIs for SCE Protected Mode that are used for secure user key updates. For a complete description of all FSP Crypto APIs, refer to the FSP User's Manual.

To use keys that have been injected via the secure key injection process using the MCUboot interfaces, the application must refer to those keys at the address where they were injected. If you inject keys at addresses other than those demonstrated above, be sure to change your application code to reflect those addresses. See instructions in section 7.4.

To perform a secure AES key update, use the following API to MCU-uniquely wrap a new AES key using a previously injected Key-Update Key:

```
fsp_err_t R_SCE_AES256_EncryptedKeyWrap (
    uint8_t *initial_vector,
    uint8_t *encrypted_key,
    sce_key_update_key_t *key_update_key,
    sce_aes_wrapped_key_t *wrapped_key )
```

The API parameters are:

- [in] `initial_vector`: Pointer to a buffer that holds the initialization vector that was used to wrap the new key. This must be the IV that was used during the key wrap process shown in section 5.1.1.4 or section 5.1.1.4. This value will be included in the generated `new_aes_key.c` and `new_aes_key.h`.
- [in] `encrypted_key`: Pointer to a buffer that holds the new key, wrapped by the KUK. In this example, it is the KUK-wrapped AES-256 key that was output during the key wrap process shown in section 5.1.1.4 or section 5.1.2.4. This value will be included in the generated `new_aes_key.c` and `new_aes_key.h`.
- [in] `key_update_key`: Pointer to the Key-Update Key that was previously injected on the MCU. This address must match the address used when injecting the KUK into section 5.2.2. The user needs to update the macro definition `KUK_ADDRESS` defined in `flash_storage.h` to match the injection address.
- [in, out] `wrapped_key`: This is the SRAM buffer to store the wrapped new user key. For security considerations, it is recommended to erase this buffer right after the wrapped key is saved to flash. In this application project, the newly generated wrapped key is stored in data flash and used in the example project.

To perform a secure ECC public key update, use the following API to MCU-uniquely wrap a new ECC public key using a previously injected Key-Update Key:

```
fsp_err_t R_SCE_ECC_secp256r1_EncryptedPublicKeyWrap (
    uint8_t * initial_vector,
    uint8_t * encrypted_key,
    sce_key_update_key_t * key_update_key,
    sce_ecc_public_wrapped_key_t * wrapped_key )
```

The API parameters are:

- [in] `initial_vector`: Pointer to a buffer that holds the initialization vector that was used to wrap the new key. This must be the IV that was used during the key wrap process shown in section 5.1.1.5 or section 5.1.2.5. This value will be included in the generated `new_ecc_public_key.c` and `new_ecc_public_key.h`.
- [in] `encrypted_key`: Pointer to a buffer that holds the new key, wrapped by the HUK. In this example, it is the KUK-wrapped ECC private key that was output during the key wrap process shown in section 5.1.1.5 or section 5.1.2.5. This value will be included in the generated `new_ecc_public_key.c` and `new_ecc_public_key.h`.
- [in] `key_update_key`: Pointer to the Key-Update Key that was previously injected on the MCU. This address must match the address used when injecting the KUK into section 5.2.2. The user needs to update the macro definition `KUK_ADDRESS` defined in `flash_storage.h` to match the injection address.
- [in, out] `wrapped_key`: This is the SRAM buffer to store the wrapped new user key. For security considerations, it is recommended to erase this buffer right after the wrapped key is saved to flash. In this application project, the newly generated wrapped key is stored in data flash and used in the example project.

7.3.1 Save the New Wrapped Key to Data Flash

Once a new key is wrapped, the user needs to use the flash driver `r_flash_hp` to manually store it in the data flash.

```
sce_aes_wrapped_key_t wrapped_new_user_key;
error = R_SCE_AES256_EncryptedKeyWrap (
    iv_encrypt_new_key, encrypted_new_key, &kuk_key, &wrapped_new_user_key );
```

Refer to function `store_new_aes_key_to_data_flash()` and function `store_new_ecc_pub_key_to_data_flash()` for the operations of storing the new wrapped keys to data flash.

7.4 Import and Compile the Example Project

Follow the steps below to exercise the example project. Note that there are sections of the code that must be updated using the secure key injection results generated above prior to compiling and running the project. Note that if the user has used the NIST vectors included in this application project for verification purposes, steps 4 to 5 can be skipped.

1. Launch e² studio and import `secure_key_inject_update_ra6m4.zip` file to a workspace.
2. At the bottom of `flash_storage.h`, find the macro definitions `DIRECT_AES_KEY_ADDRESS`, `DIRECT_ECC_PUB_KEY_ADDRESS`, and `KUK_ADDRESS` based on Figure 98.
3. Replace `new_aes_key.h` and `new_aes_key.c` with the new sets of files generated in section 5.1.1.4 or section 5.1.2.4 located in folder `\secure_key_inject_update_ra6m4_s\src\`.
4. Replace `new_ecc_public_key.c` and `new_ecc_public_key.h` generated in section 5.1.1.5 or section 5.1.2.5 located in folder `\secure_key_inject_update_ra6m4_s\src\`.
5. If different file names are used, update the `#include` definition in `aes_crypto_operations.c` on this line to reflect the new file name.

```
#include "crypto_operations.h"
#include "hal_data.h"
#include "r_sce.h"
#include "flash_storage.h"
#include "new_aes_key.h"
```

Figure 110. Include the Generated Header File for AES Operation

6. If different file names are used, update the `#include` definition in `ecc_crypto_operations.c` on this line to reflect the new file name.

```
#include <crypto_operations.h>
#include "hal_data.h"
#include "r_sce.h"
#include "flash_storage.h"
#include "new_ecc_public_key.h"
```

Figure 111. Include the Generated Header File for ECC Operation

7. Next, double-click `configuration.xml` from the secure project. Once the configurator is opened, click **Generate Project Content** and then compile the secure project.
8. Expand the non-secure project and double-click the `configuration.xml` file. Once the configurator is opened, click **Generate Project Content** and compile the non-secure project.

7.5 Running the Example Project

Prior to running the example project, the user is requested to remove Jumper J16 to put the MCU in Normal execution mode.

Once the source code compilation is successful, follow the steps below to exercise the example projects:

1. Choose to debug from the non-secure application. Right-click on `secure_key_inject_update_ra6m4_ns` and select **Debug As > Renesas GDB Hardware Debugging**.
2. Execution will halt at the secure project reset handler.

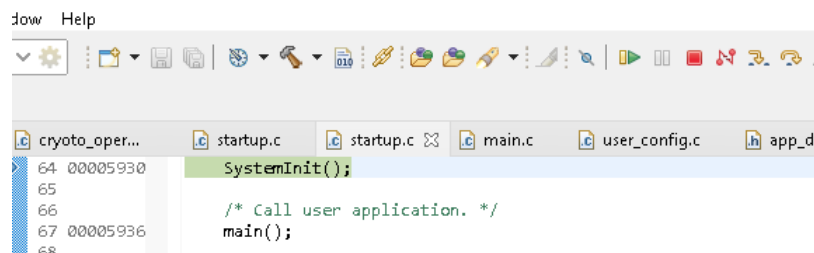



Figure 112. Running to the Secure Project Reset Handler

3. Click **Resume**  twice to run the project.
4. Open the J-Link RTT Viewer with the settings shown below.

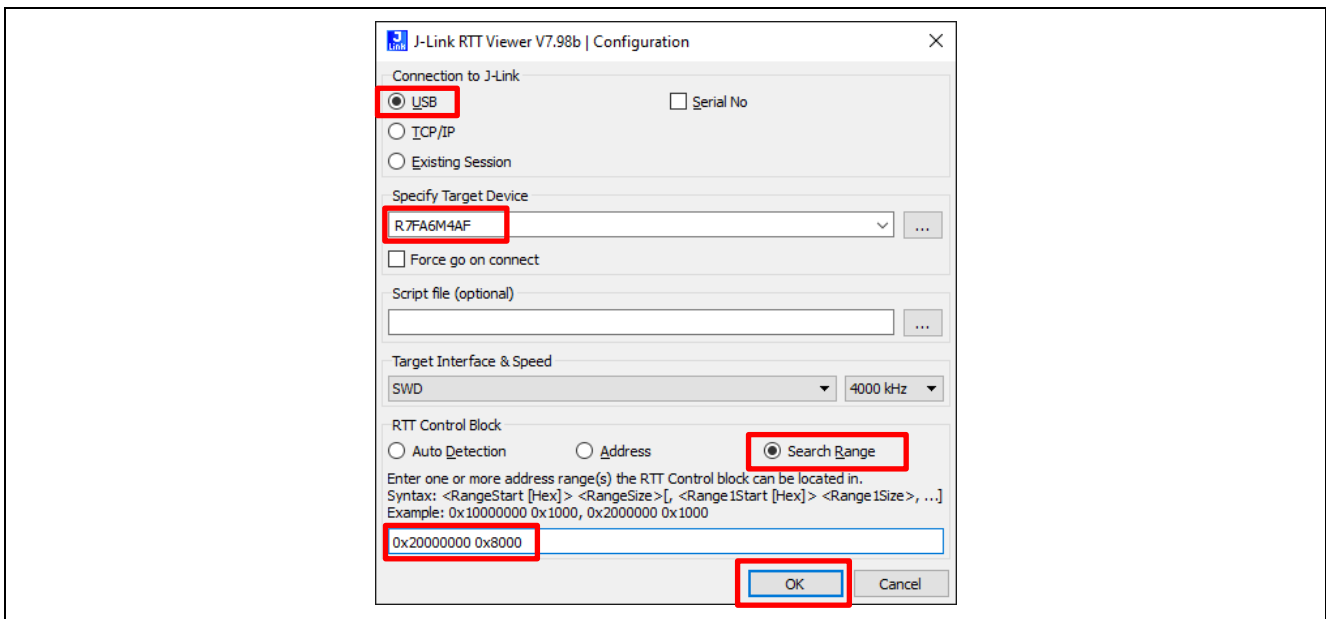

Figure 113. RTT Viewer Setting

5. Click **OK**. The following menu should be printed.

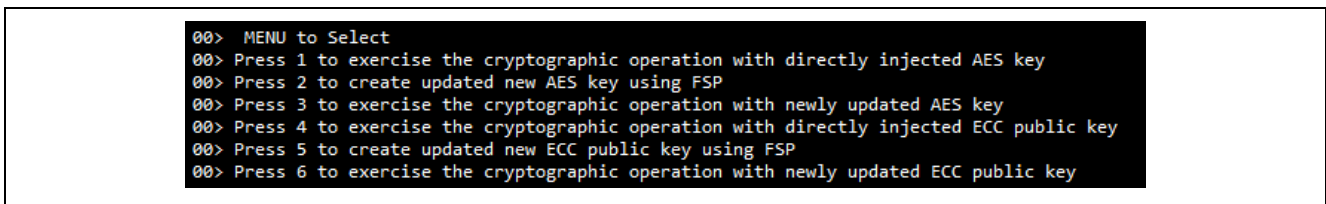

Figure 114. Main RTT User Menu

- A. Input **1** to confirm that the cipher text for the first AES key is successfully decrypted by the injected AES-256 key.

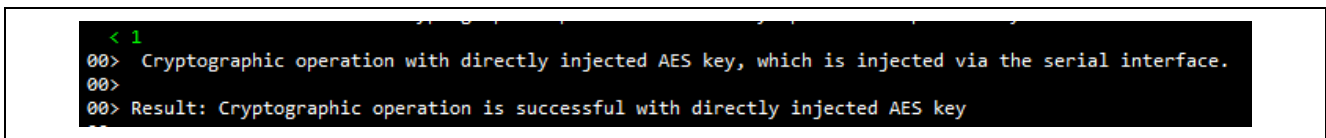

Figure 115. Crypto Operation with Injected AES-256 Key

- B. Input **2** to perform a key update to wrap the new AES-256 key and save the new key to data flash. Note that the SCE handles the wrapping of the new key internally without exposing the plaintext key. It is not possible to extract the plaintext key. The wrapped AES key in SRAM is deleted after storing it to the data flash. **Note that if menu option '1' is rerun after menu item '2' is run, it will fail because the new AES key will not generate the same cipher text as the original key.**

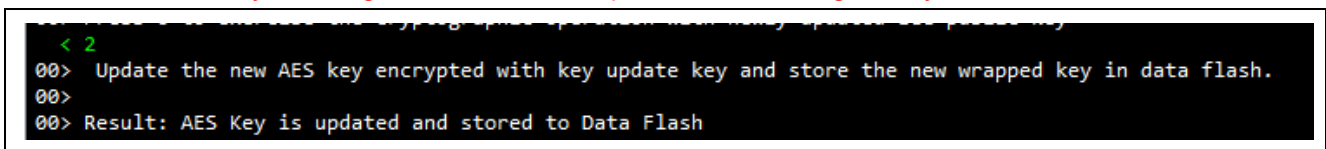

Figure 116. Update the AES Key and Store to Data Flash

- C. Input **3** to confirm that the cipher text for the second AES key is successfully decrypted by the updated AES-256 key.

```
< 3
00> Cryptographic operation with new wrapped AES key stored in data flash
00>
00>
00> Result: Cryptographic operation is successful with Updated AES Key
00>
```

Figure 117. Crypto Operation with the New AES Key

- D. Input **4** to confirm that the signature generated using the first ECC private key is successfully verified by the injected ECC public key.

```
< 4
00> Cryptographic operation with directly injected ECC public key, which is injected via the serial interface.
00>
00> Result: Cryptographic operation is successful with directly injected ECC public key
```

Figure 118. Crypto Operation with Injected ECC Public Key

- E. Input **5** to perform a key update to wrap the new ECC public key and save the new key to data flash. Note that the SCE handles the wrapping of the new key internally without exposing the plaintext key. It is not possible to extract the plaintext key. The wrapped ECC public key in SRAM is deleted after storing to data flash. **Note that if menu option '4' is rerun after menu item '5' is run, it will fail because the new ECC public key cannot verify a signature that was generated by the first key's private key.**

```
< 5
00> Update the new ECC public key encrypted with key update key and store the new wrapped key in data flash.
00>
00> Result: ECC public Key is updated and stored to Data Flash
```

Figure 119. Update the ECC Public Key and Store to Data Flash

- F. Input **6** to confirm that the signature generated using the second ECC private key is successfully verified by the updated ECC public key.

```
< 6
00> Cryptographic operation with new wrapped ECC public key stored in data flash
00>
00>
00> Result: Cryptographic operation is successful with Updated ECC public Key
```

Figure 120. Crypto Operation with the New ECC Public Key

Successful operations of the above menu items conclude the demonstration of the secure key injection and update in this application project.

8. Example Project for RA8M1 (RSIP Compatibility Mode)

This section introduces RSIP Compatibility Mode with an example of AES-128 user key injection and update.

8.1 Overview

This example project demonstrates the following functionalities of the compatibility mode of RSIP-E51A.

- AES-128 key injection using the files generated in section 6.1.
- Verifying the injected AES-128 key using PSA Crypto APIs and a NIST AES test vector.

8.2 Using the SKMT-Generated Files

The source files generated from Figure 103 are included in the example project. These files provide the UFPK-wrapped user key information used to demonstrate the functionality described in section 8.1.

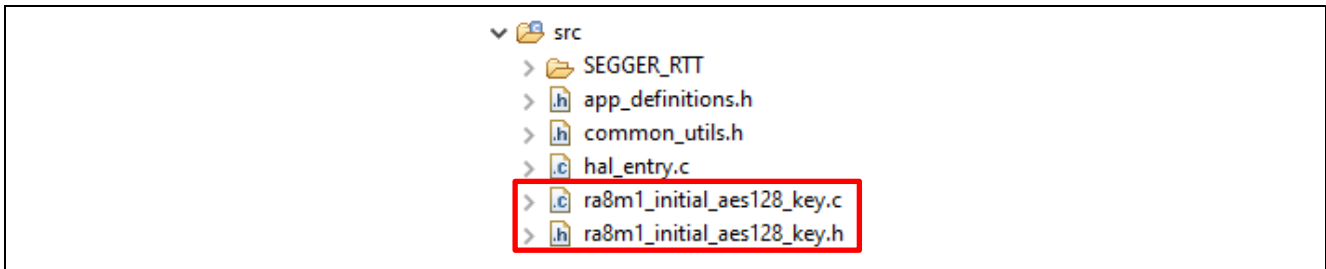

Figure 121. R8M1 Example Project Source Code

8.3 RSIP Compatibility Mode Key Injection APIs

This demonstration uses the APIs in the Key Injection module (`r_rsip_key_injection`) to perform key injection. Refer to the FSP User Manual for the complete list of key injection APIs and their parameters.

8.4 Import and Compile the Example Project

Note that if AES keys other than the NIST vectors are used, then those new source files need to replace the existing files in the example project prior to compiling and running the example project. If the NIST vectors included in this application project are being used for verification purposes, step 2 can be skipped.

1. Launch e² studio and import `secure_key_inject_ra8m1.zip` file to a workspace.
2. Replace `ra8m1_initial_aes128_key.h` and `ra8m1_initial_aes128_key.c` with the new set of files generated in Figure 106.
3. If different file names are used, update the `#include` definition in `hal_entry.c` on this line to reflect the new file name.

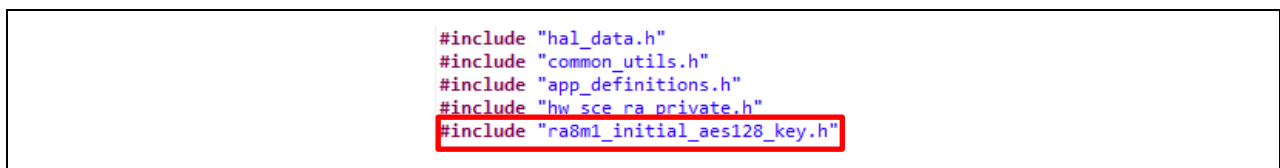

Figure 122. Include the Generated Header File for AES Operation

4. Next, double-click `configuration.xml`. Once the Configurator is opened, click **Generate Project Content** and then compile the secure project.

8.5 Running the Example Project

Follow the steps below to exercise the example projects:

1. Right-click on `secure_key_inject_ra8m1` and select **Debug As > Renesas GDB Hardware Debugging**.
2. Execution will halt at the reset handler.

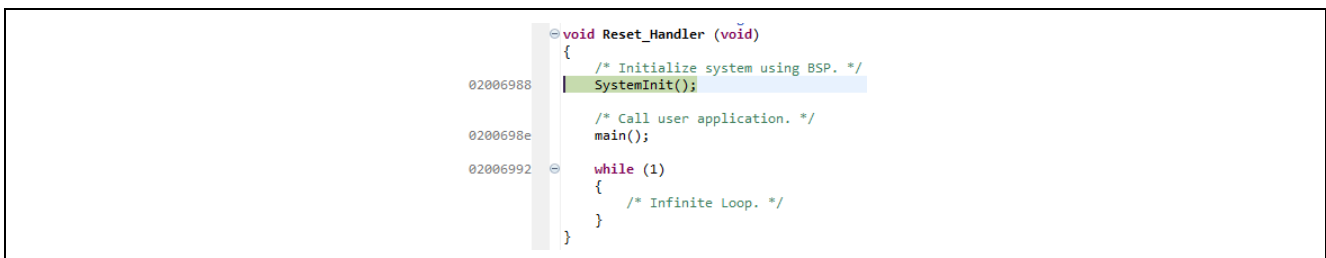



Figure 123. Running to the Project Reset Handler

3. Click **Resume**  twice to run the project.
4. Open the J-Link RTT Viewer with the settings shown below.

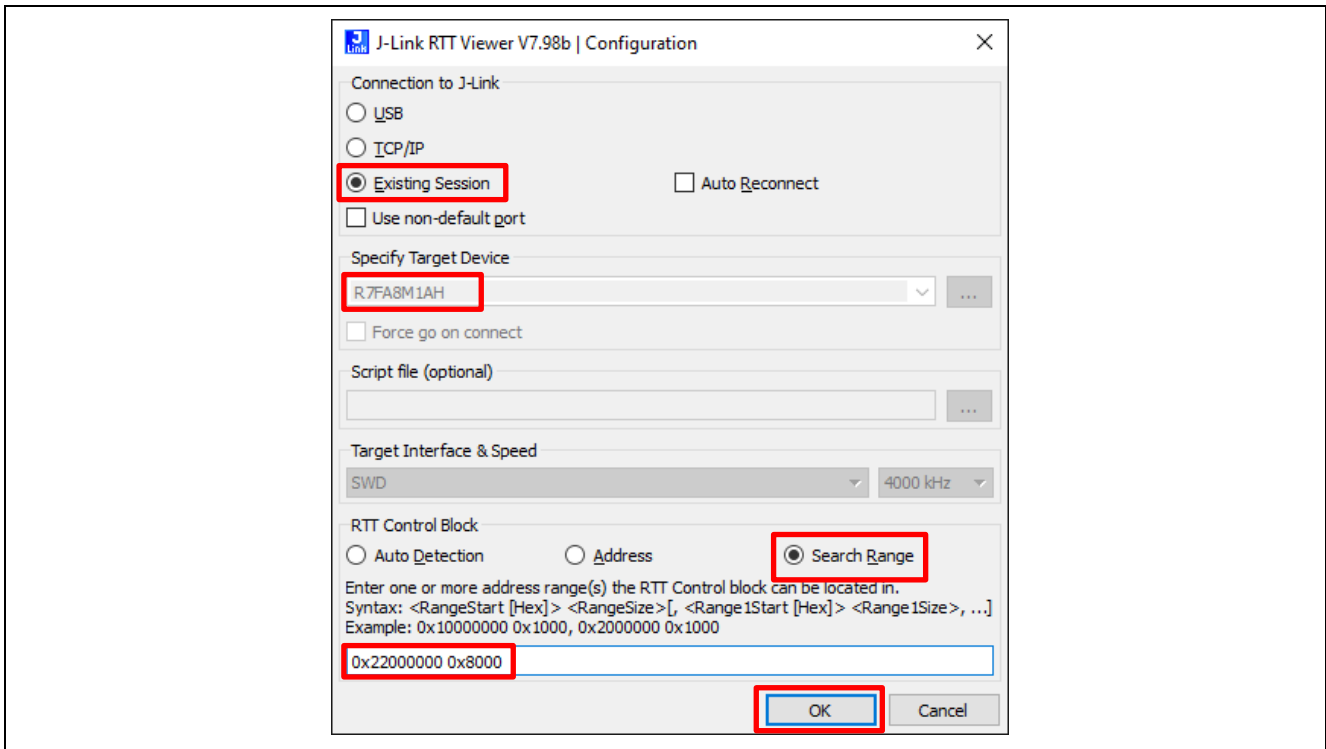

Figure 124. RTT Viewer Setting

5. Click **OK**. The following execution result should be printed. Users can step into the code to understand the code execution flow.

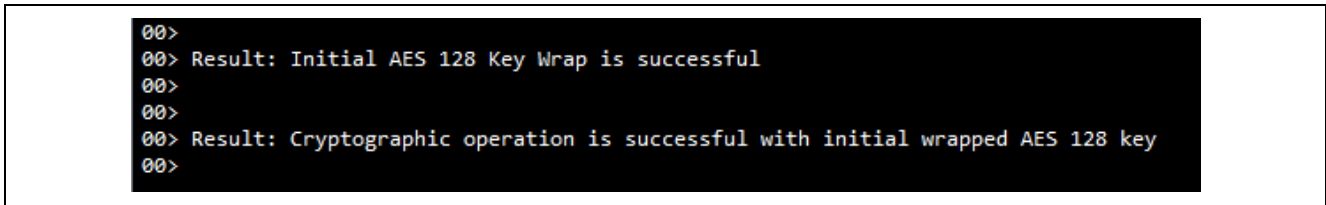

Figure 125. Execution Result - Secure Key Injection Example Project for RA8M1

9. Example Project for RA6M3 (SCE7 Compatibility Mode)

This section introduces SCE7 Compatibility Mode with an example of AES-128 user key injection and update.

9.1 Overview

This example project demonstrates the following functionalities of the compatibility mode of SCE7:

- AES-128 key injection using the files generated in section 6.2.
- Verifying the injected AES-128 key using PSA Crypto APIs and a NIST AES test vector.

9.2 Using the SKMT-Generated Files

The source files generated Section 6.2 from Figure 106 are included in the example project. These files provide the UFPK-wrapped AES key source files used to demonstrate the functionality described above.

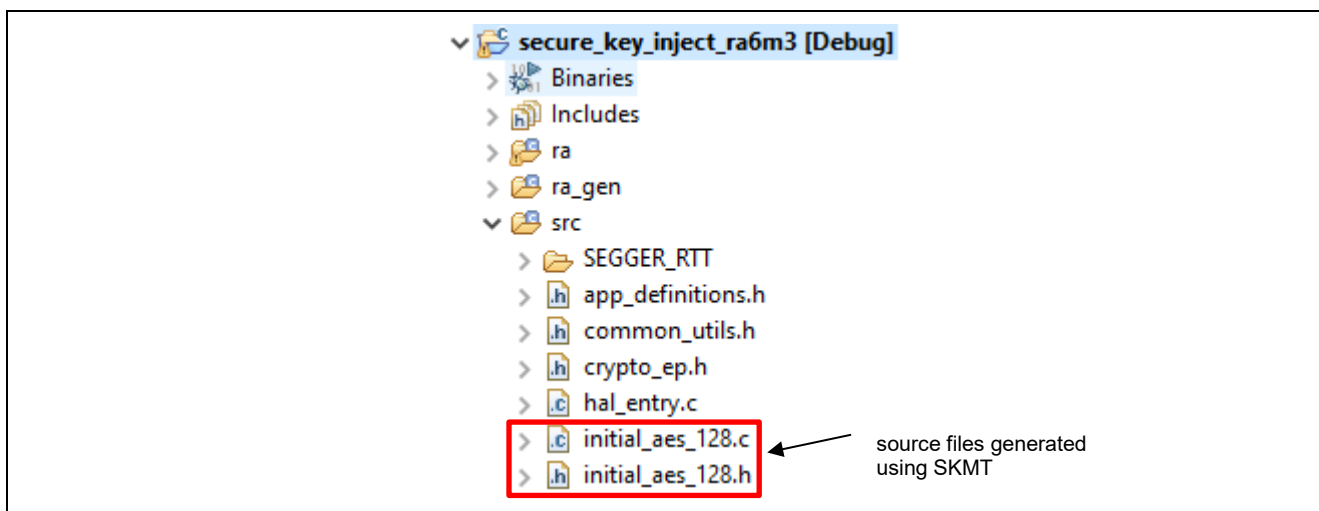

Figure 126. RA6M3 Example Project Source Code

9.3 SCE7 Compatibility Mode Key Injection APIs

This demonstration uses the APIs in the Key Injection module (`r_sce_key_injection`) to perform key injection. Refer to the FSP User Manual for the complete list of key injection APIs and their parameters.

9.4 Import and Compile the Example Project

Note that if AES keys other than the NIST vectors are used, then those new source files need to replace the existing files in the example project prior to compiling and running the example project. If the NIST vectors included in this application project are being used for verification purposes, steps 2 to 5 can be skipped.

1. Launch e² studio and import `secure_key_inject_ra6m3.zip` file to a workspace.
2. Replace `initial_aes_128.h` and `initial_aes_128.c` with the new set of files generated in Figure 106.
3. If different file names are used, update the `#include` definition in `hal_entry.c` on this line to reflect the new file name.

```
#include "hal_data.h"
#include "common_utils.h"
#include "crypto_ep.h"
#include "app_definitions.h"
#include "hw_sce_ra_private.h"
#include "initial aes 128.h"
```

Figure 127. Include the Generated Header File for AES Operation

4. Next, double-click `configuration.xml`. Once the configurator is opened, click **Generate Project Content** and then compile the project.

9.5 Running the Example Project

Follow the steps below to exercise the example projects:

6. Right-click on `secure_key_injection_ra6m3` and select **Debug As > Renesas GDB Hardware Debugging**.
7. Execution will halt at the reset handler.

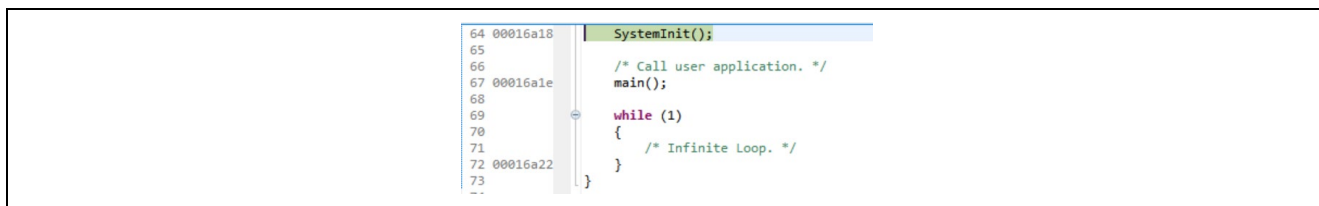



Figure 128. Running to the Project Reset Handler

8. Click **Resume**  twice to run the project.
9. Open the J-Link RTT Viewer with the settings shown below.

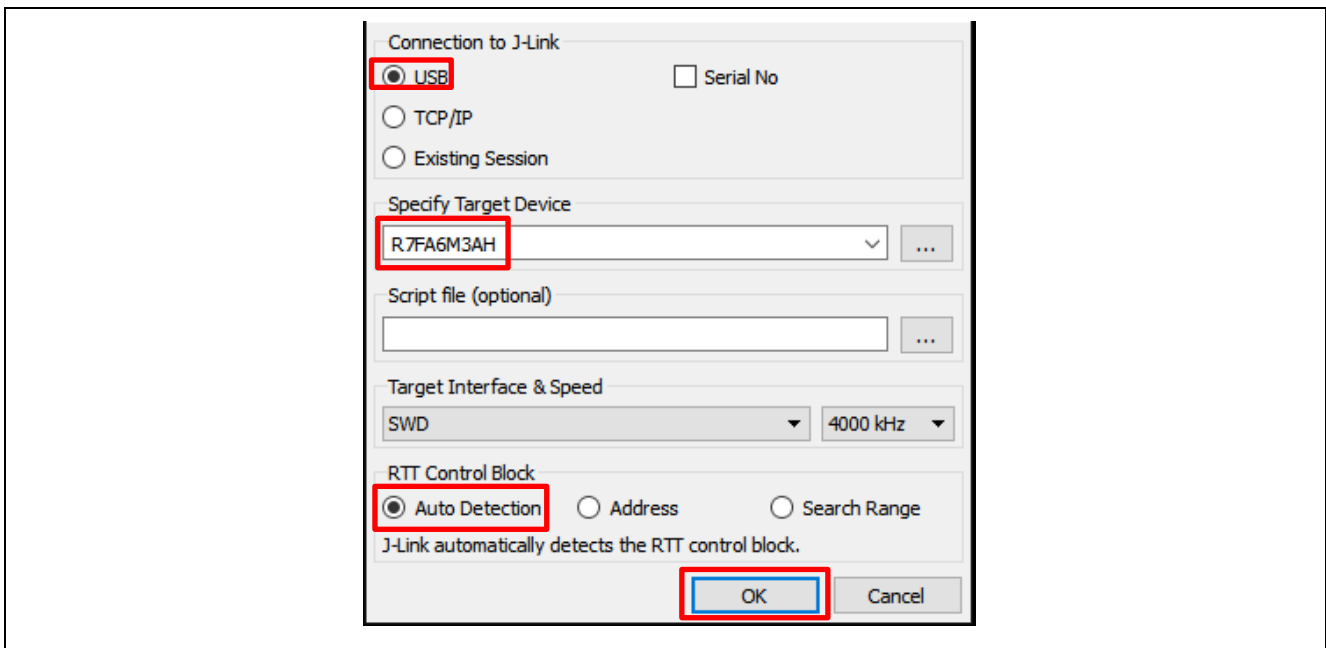

Figure 129. RTT Viewer Setting

10. Click **OK**. The following execution result should be printed. Users can step into the code to understand the code execution flow.

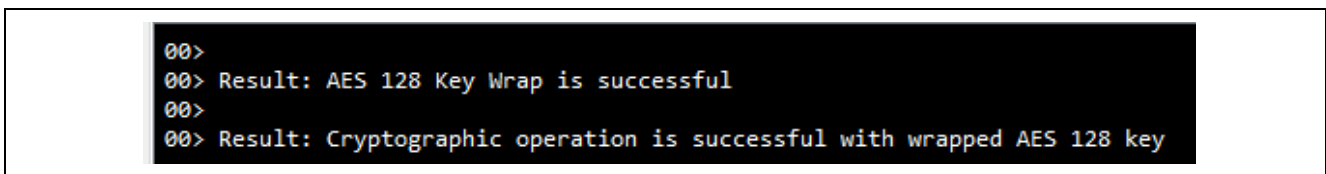

Figure 130. Execution Result - Secure Key Injection for Example Project RA6M3

10. References

1. Renesas RA Family Device Lifecycle Management Key Injection Application Note (R11AN0469)
2. Renesas RA Family Secure Crypto Engine Operational Modes Application Note (R11AN0498)
3. Renesas RA Family MCU Security Design with TrustZone® – IP Protection (R11AN0467)
4. Renesas RA Family MCU Plaintext Key Injection (R11AN0473)

11. Website and Support

Visit the following URLs to learn about the RA family of microcontrollers, download tools and documentation, and get support.

EK-RA6M4 Resources	renesas.com/ra/ek-ra6m4
EK-RA8M1 Resources	renesas.com/ra/ek-ra8m1
EK-RA6M3 Resources	renesas.com/ra/ek-ra6m3
RA Product Information	renesas.com/ra
Flexible Software Package (FSP)	renesas.com/ra/fsp
RA Product Support Forum	renesas.com/ra/forum
Renesas Support	renesas.com/support

Revision History

Rev.	Date	Description	
		Page	Summary
1.00	May.19.21	-	First release document
1.10	Jan.27.22	-	Update to use Security Key Management Tool CLI V1.0.0
1.20	Mar.25.22	-	Updated to add SKMT GUI support
1.30	Oct.25.22	-	Update to support SCE7 with FSP v4.0.0
2.00	Jan.03.24	-	Update to FSP v5.1.0
2.10	Oct.15.24	-	Update to FSP v5.5.0

General Precautions in the Handling of Microprocessing Unit and Microcontroller Unit Products

The following usage notes are applicable to all Microprocessing unit and Microcontroller unit products from Renesas. For detailed usage notes on the products covered by this document, refer to the relevant sections of the document as well as any technical updates that have been issued for the products.

1. Precaution against Electrostatic Discharge (ESD)

A strong electrical field, when exposed to a CMOS device, can cause destruction of the gate oxide and ultimately degrade the device operation. Steps must be taken to stop the generation of static electricity as much as possible, and quickly dissipate it when it occurs. Environmental control must be adequate. When it is dry, a humidifier should be used. This is recommended to avoid using insulators that can easily build up static electricity. Semiconductor devices must be stored and transported in an anti-static container, static shielding bag or conductive material. All test and measurement tools including work benches and floors must be grounded. The operator must also be grounded using a wrist strap. Semiconductor devices must not be touched with bare hands. Similar precautions must be taken for printed circuit boards with mounted semiconductor devices.

2. Processing at power-on

The state of the product is undefined at the time when power is supplied. The states of internal circuits in the LSI are indeterminate and the states of register settings and pins are undefined at the time when power is supplied. In a finished product where the reset signal is applied to the external reset pin, the states of pins are not guaranteed from the time when power is supplied until the reset process is completed. In a similar way, the states of pins in a product that is reset by an on-chip power-on reset function are not guaranteed from the time when power is supplied until the power reaches the level at which resetting is specified.

3. Input of signal during power-off state

Do not input signals or an I/O pull-up power supply while the device is powered off. The current injection that results from input of such a signal or I/O pull-up power supply may cause malfunction and the abnormal current that passes in the device at this time may cause degradation of internal elements. Follow the guideline for input signal during power-off state as described in your product documentation.

4. Handling of unused pins

Handle unused pins in accordance with the directions given under handling of unused pins in the manual. The input pins of CMOS products are generally in the high-impedance state. In operation with an unused pin in the open-circuit state, extra electromagnetic noise is induced in the vicinity of the LSI, an associated shoot-through current flows internally, and malfunctions occur due to the false recognition of the pin state as an input signal become possible.

5. Clock signals

After applying a reset, only release the reset line after the operating clock signal becomes stable. When switching the clock signal during program execution, wait until the target clock signal is stabilized. When the clock signal is generated with an external resonator or from an external oscillator during a reset, ensure that the reset line is only released after full stabilization of the clock signal. Additionally, when switching to a clock signal produced with an external resonator or by an external oscillator while program execution is in progress, wait until the target clock signal is stable.

6. Voltage application waveform at input pin

Waveform distortion due to input noise or a reflected wave may cause malfunction. If the input of the CMOS device stays in the area between V_{IL} (Max.) and V_{IH} (Min.) due to noise, for example, the device may malfunction. Take care to prevent chattering noise from entering the device when the input level is fixed, and also in the transition period when the input level passes through the area between V_{IL} (Max.) and V_{IH} (Min.).

7. Prohibition of access to reserved addresses

Access to reserved addresses is prohibited. The reserved addresses are provided for possible future expansion of functions. Do not access these addresses as the correct operation of the LSI is not guaranteed.

8. Differences between products

Before changing from one product to another, for example to a product with a different part number, confirm that the change will not lead to problems. The characteristics of a microprocessing unit or microcontroller unit products in the same group but having a different part number might differ in terms of internal memory capacity, layout pattern, and other factors, which can affect the ranges of electrical characteristics, such as characteristic values, operating margins, immunity to noise, and amount of radiated noise. When changing to a product with a different part number, implement a system-evaluation test for the given product.

Notice

1. Descriptions of circuits, software and other related information in this document are provided only to illustrate the operation of semiconductor products and application examples. You are fully responsible for the incorporation or any other use of the circuits, software, and information in the design of your product or system. Renesas Electronics disclaims any and all liability for any losses and damages incurred by you or third parties arising from the use of these circuits, software, or information.
2. Renesas Electronics hereby expressly disclaims any warranties against and liability for infringement or any other claims involving patents, copyrights, or other intellectual property rights of third parties, by or arising from the use of Renesas Electronics products or technical information described in this document, including but not limited to, the product data, drawings, charts, programs, algorithms, and application examples.
3. No license, express, implied or otherwise, is granted hereby under any patents, copyrights or other intellectual property rights of Renesas Electronics or others.
4. You shall be responsible for determining what licenses are required from any third parties, and obtaining such licenses for the lawful import, export, manufacture, sales, utilization, distribution or other disposal of any products incorporating Renesas Electronics products, if required.
5. You shall not alter, modify, copy, or reverse engineer any Renesas Electronics product, whether in whole or in part. Renesas Electronics disclaims any and all liability for any losses or damages incurred by you or third parties arising from such alteration, modification, copying or reverse engineering.
6. Renesas Electronics products are classified according to the following two quality grades: "Standard" and "High Quality". The intended applications for each Renesas Electronics product depends on the product's quality grade, as indicated below.

"Standard": Computers; office equipment; communications equipment; test and measurement equipment; audio and visual equipment; home electronic appliances; machine tools; personal electronic equipment; industrial robots; etc.

"High Quality": Transportation equipment (automobiles, trains, ships, etc.); traffic control (traffic lights); large-scale communication equipment; key financial terminal systems; safety control equipment; etc.

Unless expressly designated as a high reliability product or a product for harsh environments in a Renesas Electronics data sheet or other Renesas Electronics document, Renesas Electronics products are not intended or authorized for use in products or systems that may pose a direct threat to human life or bodily injury (artificial life support devices or systems; surgical implantations; etc.), or may cause serious property damage (space system; undersea repeaters; nuclear power control systems; aircraft control systems; key plant systems; military equipment; etc.). Renesas Electronics disclaims any and all liability for any damages or losses incurred by you or any third parties arising from the use of any Renesas Electronics product that is inconsistent with any Renesas Electronics data sheet, user's manual or other Renesas Electronics document.
7. No semiconductor product is absolutely secure. Notwithstanding any security measures or features that may be implemented in Renesas Electronics hardware or software products, Renesas Electronics shall have absolutely no liability arising out of any vulnerability or security breach, including but not limited to any unauthorized access to or use of a Renesas Electronics product or a system that uses a Renesas Electronics product. RENESAS ELECTRONICS DOES NOT WARRANT OR GUARANTEE THAT RENESAS ELECTRONICS PRODUCTS, OR ANY SYSTEMS CREATED USING RENESAS ELECTRONICS PRODUCTS WILL BE INVULNERABLE OR FREE FROM CORRUPTION, ATTACK, VIRUSES, INTERFERENCE, HACKING, DATA LOSS OR THEFT, OR OTHER SECURITY INTRUSION ("Vulnerability Issues"). RENESAS ELECTRONICS DISCLAIMS ANY AND ALL RESPONSIBILITY OR LIABILITY ARISING FROM OR RELATED TO ANY VULNERABILITY ISSUES. FURTHERMORE, TO THE EXTENT PERMITTED BY APPLICABLE LAW, RENESAS ELECTRONICS DISCLAIMS ANY AND ALL WARRANTIES, EXPRESS OR IMPLIED, WITH RESPECT TO THIS DOCUMENT AND ANY RELATED OR ACCOMPANYING SOFTWARE OR HARDWARE, INCLUDING BUT NOT LIMITED TO THE IMPLIED WARRANTIES OF MERCHANTABILITY, OR FITNESS FOR A PARTICULAR PURPOSE.
8. When using Renesas Electronics products, refer to the latest product information (data sheets, user's manuals, application notes, "General Notes for Handling and Using Semiconductor Devices" in the reliability handbook, etc.), and ensure that usage conditions are within the ranges specified by Renesas Electronics with respect to maximum ratings, operating power supply voltage range, heat dissipation characteristics, installation, etc. Renesas Electronics disclaims any and all liability for any malfunctions, failure or accident arising out of the use of Renesas Electronics products outside of such specified ranges.
9. Although Renesas Electronics endeavors to improve the quality and reliability of Renesas Electronics products, semiconductor products have specific characteristics, such as the occurrence of failure at a certain rate and malfunctions under certain use conditions. Unless designated as a high reliability product or a product for harsh environments in a Renesas Electronics data sheet or other Renesas Electronics document, Renesas Electronics products are not subject to radiation resistance design. You are responsible for implementing safety measures to guard against the possibility of bodily injury, injury or damage caused by fire, and/or danger to the public in the event of a failure or malfunction of Renesas Electronics products, such as safety design for hardware and software, including but not limited to redundancy, fire control and malfunction prevention, appropriate treatment for aging degradation or any other appropriate measures. Because the evaluation of microcomputer software alone is very difficult and impractical, you are responsible for evaluating the safety of the final products or systems manufactured by you.
10. Please contact a Renesas Electronics sales office for details as to environmental matters such as the environmental compatibility of each Renesas Electronics product. You are responsible for carefully and sufficiently investigating applicable laws and regulations that regulate the inclusion or use of controlled substances, including without limitation, the EU RoHS Directive, and using Renesas Electronics products in compliance with all these applicable laws and regulations. Renesas Electronics disclaims any and all liability for damages or losses occurring as a result of your noncompliance with applicable laws and regulations.
11. Renesas Electronics products and technologies shall not be used for or incorporated into any products or systems whose manufacture, use, or sale is prohibited under any applicable domestic or foreign laws or regulations. You shall comply with any applicable export control laws and regulations promulgated and administered by the governments of any countries asserting jurisdiction over the parties or transactions.
12. It is the responsibility of the buyer or distributor of Renesas Electronics products, or any other party who distributes, disposes of, or otherwise sells or transfers the product to a third party, to notify such third party in advance of the contents and conditions set forth in this document.
13. This document shall not be reprinted, reproduced or duplicated in any form, in whole or in part, without prior written consent of Renesas Electronics.
14. Please contact a Renesas Electronics sales office if you have any questions regarding the information contained in this document or Renesas Electronics products.

(Note1) "Renesas Electronics" as used in this document means Renesas Electronics Corporation and also includes its directly or indirectly controlled subsidiaries.

(Note2) "Renesas Electronics product(s)" means any product developed or manufactured by or for Renesas Electronics.

(Rev.5.0-1 October 2020)

Corporate Headquarters

TOYOSU FORESIA, 3-2-24 Toyosu,
Koto-ku, Tokyo 135-0061, Japan
www.renesas.com

Trademarks

Renesas and the Renesas logo are trademarks of Renesas Electronics Corporation. All trademarks and registered trademarks are the property of their respective owners.

Contact information

For further information on a product, technology, the most up-to-date version of a document, or your nearest sales office, please visit:
www.renesas.com/contact/