

RTK0EE0013D10002BJ

Electrical Characteristics of 860-MHz-Band RF Transceiver (ETSI EN 300 220)

Introduction

This document shows the electrical characteristics measurement results in the 860 MHz band with the RF part of the RTK0EE0013D10002BJ (R9A06G062GNP CE/UKCA-Compliant Sub-GHz Wireless Communication Evaluation Kit). The target regulation is “ETSI EN 300 220” and the frequency band is 863MHz to 870MHz.

Note: The contents of this document are provided as an example for reference and do not guarantee the signal quality in systems. When implementing this example into an existing system, thoroughly evaluate the product in the overall system and apply the contents of this document at your own responsibility.

Target Device

R9A06G062GNP

Contents

1. Evaluation condition	2
1.1 System configuration.....	2
1.2 Temperature and supply voltage conditions	2
2. Electrical Characteristics	3
2.1 Current Characteristics.....	3
2.1.1 FSK (50kbps, modulation index = 0.5).....	3
2.1.2 OFDM (Option4, MCS6).....	3
2.2 TX Electrical Characteristics	4
2.2.1 FSK (50kbps, modulation index = 0.5).....	4
2.2.2 FSK (100kbps, modulation index = 0.5).....	12
2.2.3 OFDM (Option4, MCS6).....	20
2.3 RX Electrical Characteristics	27
2.3.1 FSK (50kbps, modulation index = 0.5).....	27
2.3.2 FSK (100kbps, modulation index = 0.5).....	30
2.3.3 OFDM (Option4, MCS6).....	33
3. Detailed information on the Evaluation Kit.....	36
Revision History	37

1. Evaluation condition

1.1 System configuration

Figure 1 shows the RF part of Evaluation kit to be evaluated. Table 1 shows common evaluation conditions. The evaluation target described in this document is Daughter Board of Evaluation kit. The configuration of the evaluation kit including the motherboard can viewed at be the user's manual (r02uz0005ejxxx-sub-ghz).

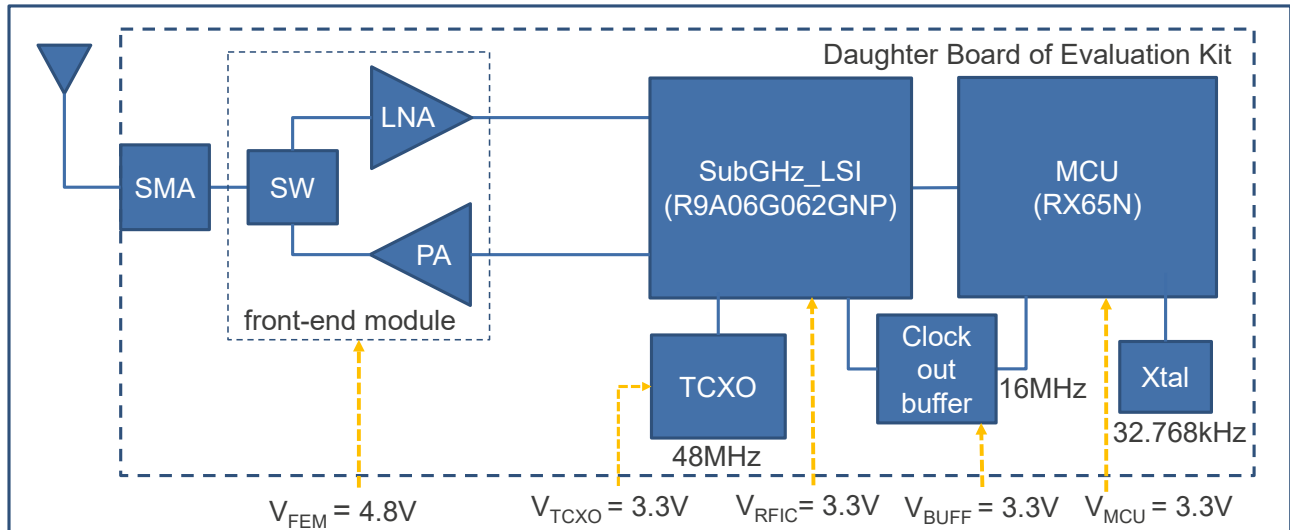

Figure 1 System Configuration

1.2 Temperature and supply voltage conditions

Table 1 shows the temperature and voltage settings for each part during evaluation.

Table 1 Temperature and supply voltage conditions

Item	Conditions
Temperature	25deg C
MCU Main clock	96MHz
V _{FEM}	Voltage supplied to FEM
V _{TCXO}	Voltage supplied to TCXO
V _{RFIC}	Voltage supplied to R9A06G062GNP
V _{BUFF}	Voltage supplied to Clock out buffer IC
V _{MCU}	Voltage supplied to MCU

2. Electrical Characteristics

2.1 Current Characteristics

2.1.1 FSK (50kbps, modulation index = 0.5)

Table 2 shows the current value in each mode for each power supply.

Table 2 Current Characteristics

Item		RF Frequency [MHz]	TX Power [dBm]	Unit	Evaluation results
TX Mode	V _{RFIC}	866.5	+12	mA	15.2
	V _{FEM}			mA	96.0
	V _{MCU}			mA	15.2
RX Mode	V _{RFIC}	866.5	-	mA	17.5
	V _{FEM}			mA	6.3
	V _{MCU}			mA	15.2
Idle Mode	V _{RFIC}	866.5	-	mA	5.8
	V _{FEM}			uA	6.6
	V _{MCU}			mA	15.1

2.1.2 OFDM (Option4, MCS6)

Table 3 shows the current value in each mode for each power supply.

Table 3 Current Characteristics

Item		RF Frequency [MHz]	TX Power [dBm]	Unit	Evaluation results
TX Mode	V _{RFIC}	866.5	+12	mA	37.0
	V _{FEM}			mA	99.1
	V _{MCU}			mA	15.2
RX Mode	V _{RFIC}	866.5	-	mA	22.5
	V _{FEM}			mA	6.3
	V _{MCU}			mA	15.2
Idle Mode	V _{RFIC}	866.5	-	mA	5.8
	V _{FEM}			uA	6.6
	V _{MCU}			mA	15.1

2.2 TX Electrical Characteristics

2.2.1 FSK (50kbps, modulation index = 0.5)

(1) TX Power sweep characteristics

Signal condition: Frequency = 866.5MHz

Table 4 TX Power sweep characteristics

Items		Unit	Evaluation results
TX Power Range	Max	dBm	31.6
	Min		4.6
	Variable power range	dB	27.0
Current Range	V _{FEM}	Max	794.8
		Min	65.7
	V _{RFIC}	Max	68.2
		Min	13.5

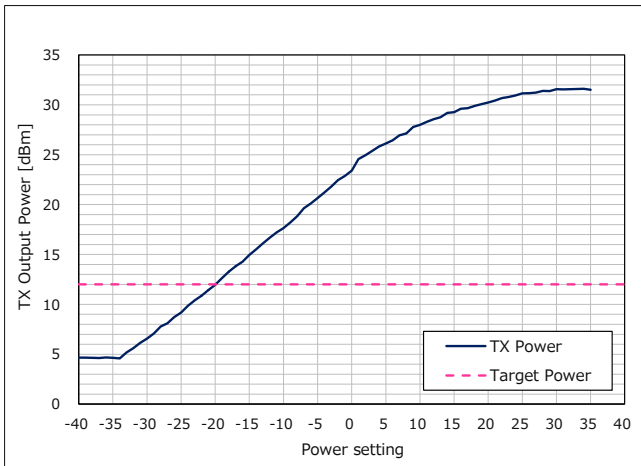

Figure 2 Power Setting vs. TX Power (Frequency = 866.5MHz)

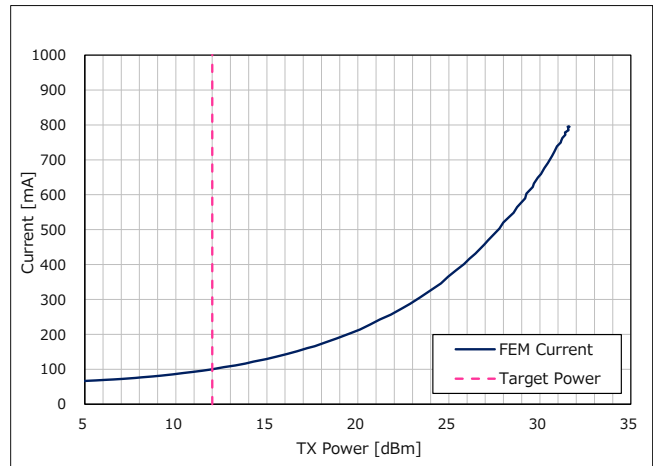

Figure 3 TX Power vs. Current of V_{FEM} for TX mode (Frequency = 866.5MHz)

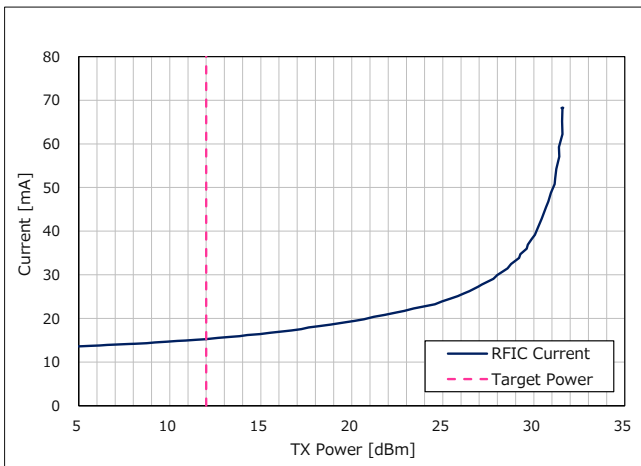

Figure 4 TX Power vs. Current of V_{RFIC} for TX mode (Frequency = 866.5MHz)

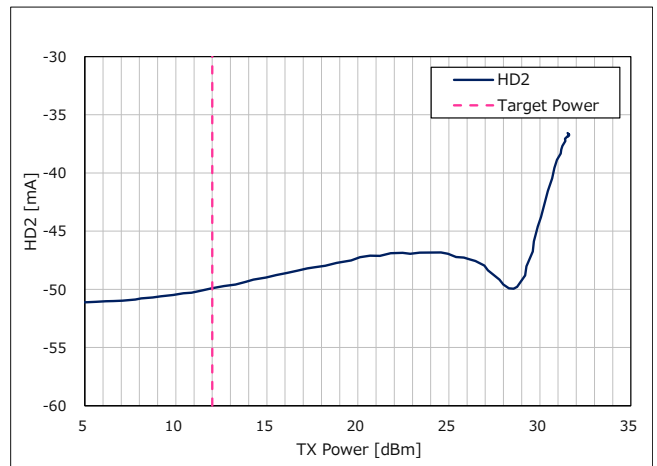

Figure 5 TX Power vs. 2nd Harmonics (Frequency = 866.5MHz)

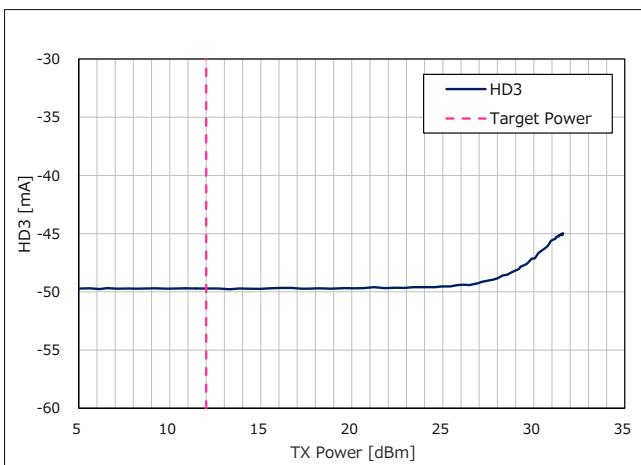

Figure 6 TX Power vs. 3rd Harmonics (Frequency = 866.5MHz)

(2) TX Radio Regulations characteristics

Signal condition: Target TX Power = +12dBm

Table 5 TX Radio Regulations characteristics (1/4)

Items		RF Frequency [MHz]	Unit	Evaluation results	Spec
TX Power		863.1	dBm	11.5	14 (*1)
		866.5		11.5	
		869.9		11.4	
Harmonics	2nd	863.1	dBm /MHz	-60.8	-30 (*1)
		866.5		-59.4	
		869.9		-58.5	
	3rd	863.1		-64.9	-30 (*1)
		866.5		-65.0	
		869.9		-65.1	
Occupied Bandwidth		863.1	kHz	52.6	-
		866.5		52.4	
		869.9		52.2	
Adjacent Channel Power Ratio (M1_Lower, 84.375 kHz offset) (*2)		863.1	dBc	-43.3	-20 (*4)
		866.5		-43.2	
		869.9		-43.3	
Adjacent Channel Power Ratio (M1_Upper, 84.375 kHz offset) (*2)		863.1	dBc	-42.5	-20 (*4)
		866.5		-42.7	
		869.9		-42.3	
Adjacent Channel Power Ratio (M2_Lower, 168.75 kHz offset) (*2)		863.1	dBc	-61.0	-35 (*4)
		866.5		-60.8	
		869.9		-60.7	
Adjacent Channel Power Ratio (M2_Upper, 168.75 kHz offset) (*2)		863.1	dBc	-61.1	-35 (*4)
		866.5		-60.6	
		869.9		-60.7	
Deviation Offset		863.1	% rms	4.2	30 (*3)
		866.5		4.2	
		869.9		4.3	
Zero Crossing Error		863.1	% pk	2.0	±12.5 (*3)
		866.5		2.6	
		869.9		2.1	
Frequency tolerance (*5)		866.5	ppm	0.5	±11.5 (*1)

(*1) ETSI EN 300 220-2 V3.3.1(2018-06)

(*2) IEEE.802.15.4-2020

 M1: $9/16 \cdot S \cdot (h+1)$, M2: $9/8 \cdot S \cdot (h+1)$, S(Channel spacing): 100kHz, h(modulation index): 0.5

(*3) Wi-SUN PHY Technical Specification - Amendment 1VA9 (11 Nov 2022). (*4) IEEE.802.15.4-2020

(*5) This characteristic depends on TCXO.

Table 6 TX Radio Regulations characteristics (2/4)

Items		RF Frequency [MHz]	Unit	Evaluation results	Spec
Unwanted emissions	9 kHz - 47 MHz	863.1	dBm /100kHz	-50.3	-36 (*1)
		866.5		-51.6	
		869.9		-52.4	
	47 MHz - 74 MHz	863.1	dBm /100kHz	-70.2	-54 (*1)
		866.5		-70.6	
		869.9		-71.0	
	74 MHz - 87.5 MHz	863.1	dBm /100kHz	-70.3	-36 (*1)
		866.5		-70.6	
		869.9		-70.6	
	87.5 MHz - 118 MHz	863.1	dBm /100kHz	-70.1	-54 (*1)
		866.5		-70.5	
		869.9		-69.6	
	118 MHz - 174 MHz	863.1	dBm /100kHz	-69.3	-36 (*1)
		866.5		-69.8	
		869.9		-69.0	
	174 MHz - 230 MHz	863.1	dBm /100kHz	-68.8	-54 (*1)
		866.5		-69.8	
		869.9		-69.7	
	230 MHz - 470 MHz	863.1	dBm /100kHz	-67.8	-36 (*1)
		866.5		-68.7	
		869.9		-68.8	
	470 MHz - 790 MHz	863.1	dBm /100kHz	-64.1	-54 (*1)
		866.5		-65.0	
		869.9		-64.8	
790 MHz - fc-m MHz (*2)	863.1	dBm /100kHz	-57.3	-36 (*1)	
	866.5		-56.8		
	869.9		-57.0		
fc-m MHz - fc-n MHz (*2)	863.1	dBm /10kHz	-55.5	-36 (*1)	
	866.5		-58.1		
	869.9		-56.5		
fc-n MHz - fc-p MHz (*2)	863.1	dBm /kHz	-62.0	-36 (*1)	
	866.5		-62.4		
	869.9		-62.1		
fc+p MHz - fc+n MHz (*2)	863.1	dBm /kHz	-60.1	-36 (*1)	
	866.5		-60.8		
	869.9		-61.1		

(*1) ETSI EN 300 220-2 V3.3.1(2018-06)

(*2) fc: Operating frequency m: 1MHz n: 0.4MHz p: 0.25MHz

m/n/p are in the case of operating channel width: 100kHz

Table 7 TX Radio Regulations characteristics (3/4)

Items		RF Frequency [MHz]	Unit	Evaluation results	Spec
Unwanted emissions	fc+n MHz - fc+m MHz (*2)	863.1	dBm /10kHz	-59.1	-36 (*1)
		866.5		-57.2	
		869.9		-56.9	
	fc+m MHz - 1 GHz (*2)	863.1	dBm /100kHz	-56.3	-36 (*1)
		866.5		-54.4	
		869.9		-57.3	
	1 GHz - 6 GHz	863.1	dBm /MHz	-50.6	-30 (*1)
		866.5		-50.2	
		869.9		-50.2	
Transient power	$\pm 0.5 \cdot \text{OCW}$ $\pm 3\text{kHz}$ (*3)	863.1	dBm /kHz	-31.5	0 (*1)
		866.5		-31.4	
		869.9		-31.4	
	$\pm \text{OCW}$ (*3)	863.1	dBm /kHz	-39.2	0 (*1)
		866.5		-39.0	
		869.9		-39.1	
	$\pm 0.5 \cdot \text{OCW}$ $\pm 400\text{kHz}$ (*3)	863.1	dBm /kHz	-67.9	-27 (*1)
		866.5		-68.0	
		869.9		-67.9	
	$\pm 0.5 \cdot \text{OCW}$ $\pm 1200\text{kHz}$ (*3)	863.1	dBm /kHz	-83.3	-27 (*1)
		866.5		-83.4	
		869.9		-83.2	

(*1) ETSI EN 300 220-2 V3.3.1(2018-06)

(*2) fc: Operating frequency m: 1MHz n: 0.4MHz p: 0.25MHz
m/n/p are in the case of operating channel width: 100kHz

(*3) OCW: 100kHz

Table 8 TX Radio Regulations characteristics (4/4)

Items		RF Frequency [MHz]	Unit	Evaluation results	Spec
Tx out of band emission (around)	$f \leq f_c - 2.5OCW$	863.1	dBm /kHz	PASS (Refer to Figure 7)	-36 (*1)
		866.5		PASS (Refer to Figure 8)	
		869.9		PASS (Refer to Figure 9)	
	$f_c - 2.5OCW \leq f < f_c - 0.5OCW$ (Margin)	863.1	dB	PASS (Refer to Figure 7)	0 (*1)
		866.5		PASS (Refer to Figure 8)	
		869.9		PASS (Refer to Figure 9)	
	$f_c + 0.5OCW < f \leq f_c + 2.5OCW$ (Margin)	863.1	dB	PASS (Refer to Figure 7)	0 (*1)
		866.5		PASS (Refer to Figure 8)	
		869.9		PASS (Refer to Figure 9)	
	$f_c + 2.5OCW \leq f$	863.1	dBm /kHz	PASS (Refer to Figure 7)	-36 (*1)
		866.5		PASS (Refer to Figure 8)	
		869.9		PASS (Refer to Figure 9)	
Tx out of band emission (Band edge)	$f \leq f_{low} - 0.4MHz$ (*2)	863.1	dBm /10kHz	PASS (Refer to Figure 10)	-36 (*1)
		866.5		PASS (Refer to Figure 11)	
		869.9		PASS (Refer to Figure 12)	
	$f_{low} - 0.4MHz < f \leq f_{low} - 0.2MHz$ (*2)	863.1	dBm /kHz	PASS (Refer to Figure 10)	
		866.5		PASS (Refer to Figure 11)	
		869.9		PASS (Refer to Figure 12)	
	$f_{low} - 0.2MHz \leq f < f_{low}$ (Margin) (*2)	863.1	dB	PASS (Refer to Figure 10)	0 (*1)
		866.5		PASS (Refer to Figure 11)	
		869.9		PASS (Refer to Figure 12)	
	$f_{high} < f \leq f_{high} + 0.2MHz$ (Margin) (*2)	863.1	dB	PASS (Refer to Figure 10)	0 (*1)
		866.5		PASS (Refer to Figure 11)	
		869.9		PASS (Refer to Figure 12)	
	$f_{high} + 0.2MHz < f \leq f_{high} + 0.4MHz$ (*2)	863.1	dBm /kHz	PASS (Refer to Figure 10)	-36 (*1)
		866.5		PASS (Refer to Figure 11)	
		869.9		PASS (Refer to Figure 12)	
	$f_{high} + 0.4MHz \leq f$ (*2)	863.1	dBm /10kHz	PASS (Refer to Figure 10)	
		866.5		PASS (Refer to Figure 11)	
		869.9		PASS (Refer to Figure 12)	

(*1) ETSI EN 300 220-2 V3.3.1(2018-06)

(*2) f_{low} : 863MHz f_{high} : 870MHz

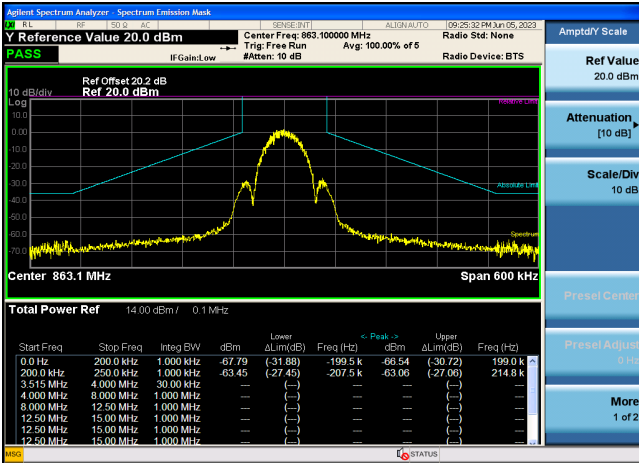

Figure 7 TX Out of Band Emissions for Operating Channel (Frequency = 863.1MHz)

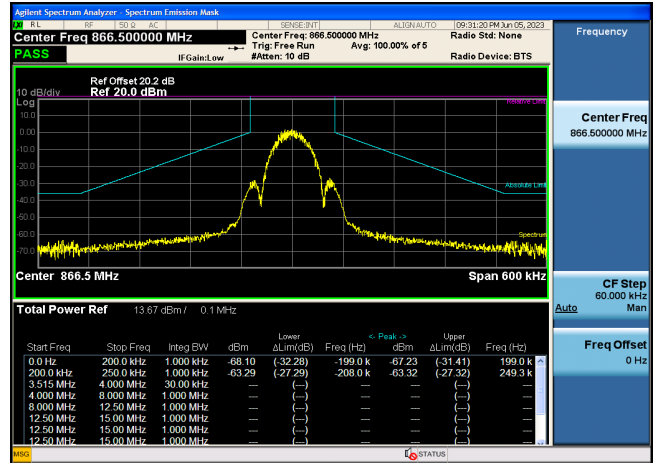

Figure 8 TX Out of Band Emissions for Operating Channel (Frequency = 866.5MHz)

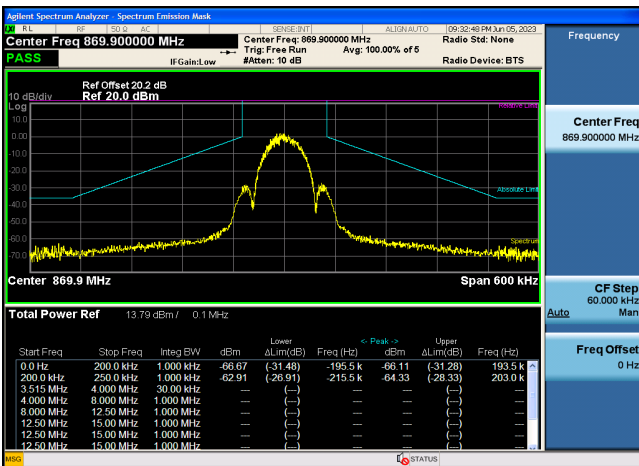

Figure 9 TX Out of Band Emissions for Operating Channel (Frequency = 869.9MHz)

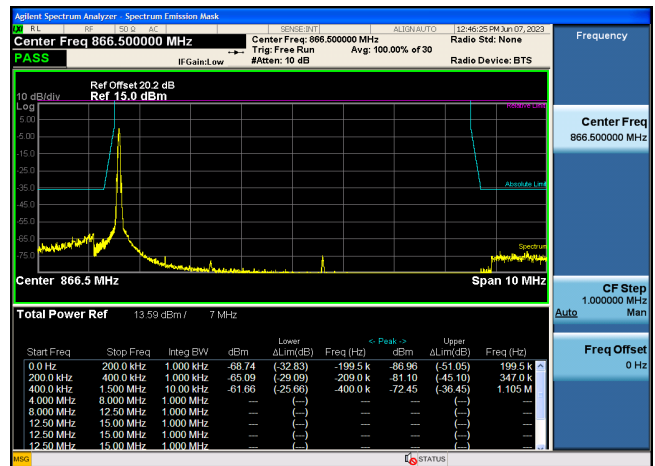

Figure 10 TX Out of Band Emissions for Operational Frequency Band (Frequency = 863.1MHz)

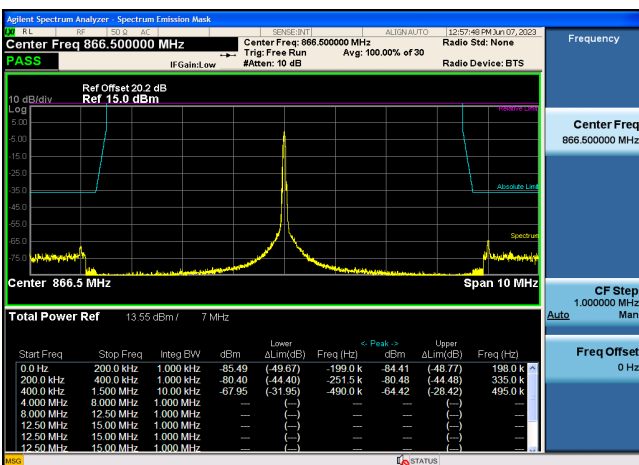

Figure 11 TX Out of Band Emissions for Operational Frequency Band (Frequency = 866.5MHz)

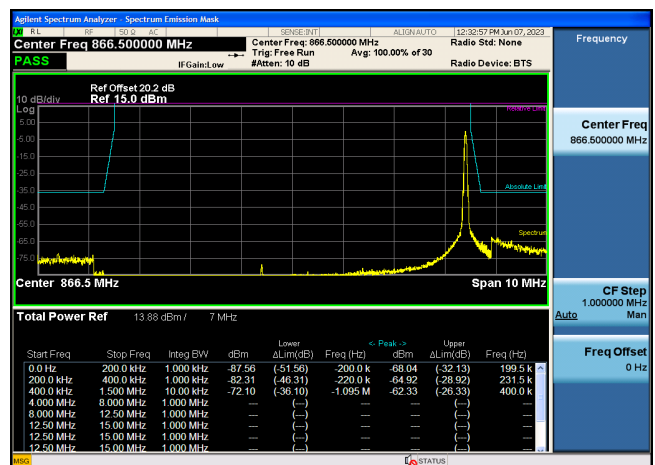

Figure 12 TX Out of Band Emissions for Operational Frequency Band (Frequency = 869.9MHz)

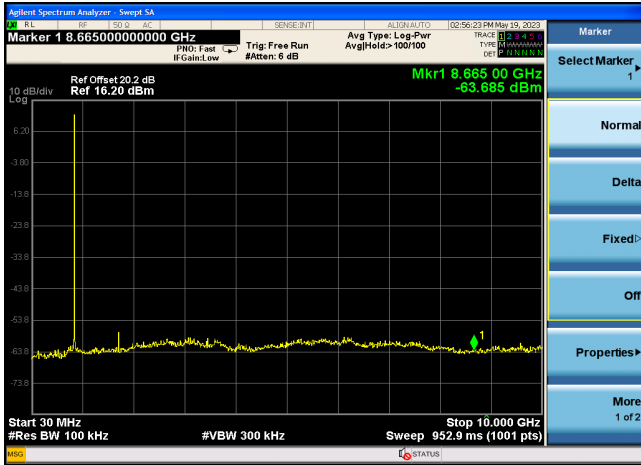

Figure 13 TX Spurious emission (Frequency = 866.5MHz)

2.2.2 FSK (100kbps, modulation index = 0.5)

(1) TX Power sweep characteristics

Signal condition: Frequency = 866.5MHz

Table 9 TX Power sweep characteristics

Items		Unit	Evaluation results
TX Power Range	Max	dBm	31.7
	Min		4.7
	Variable power range	dB	27
Current Range	V _{FEM}	Max	796.8
		Min	65.7
	V _{RFIC}	Max	68.2
		Min	13.6

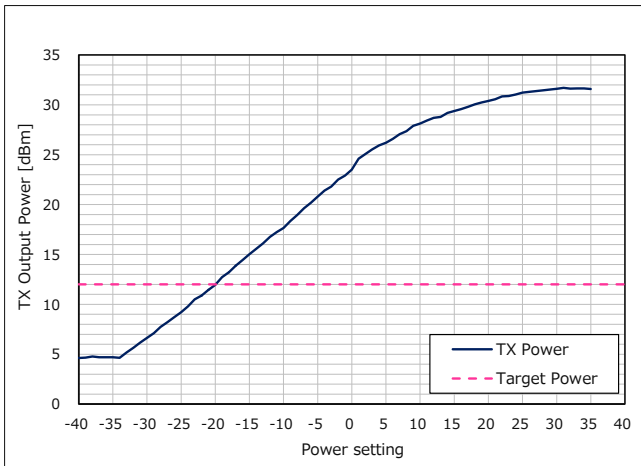

Figure 14 Power Setting vs. TX Power (Frequency = 866.5MHz)

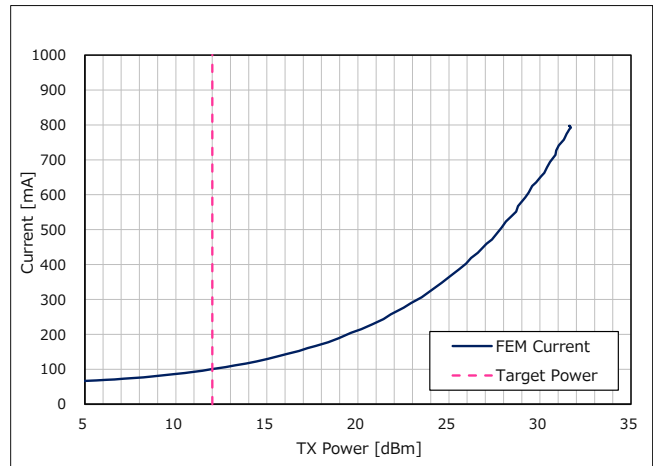

Figure 15 TX Power vs. Current of V_{FEM} for TX mode (Frequency = 866.5MHz)

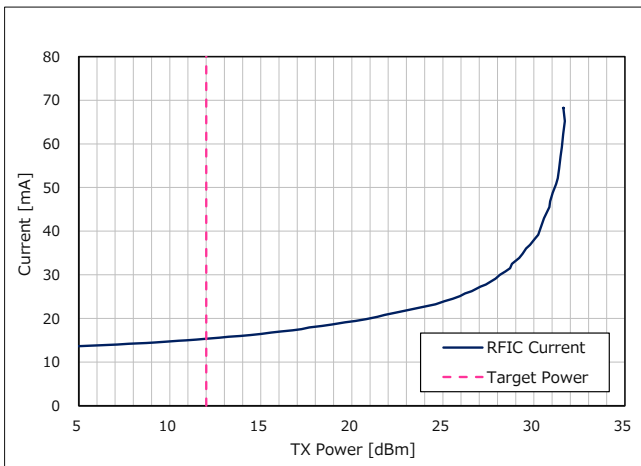

Figure 16 TX Power vs. Current of V_{RFIC} for TX mode (Frequency = 866.5MHz)

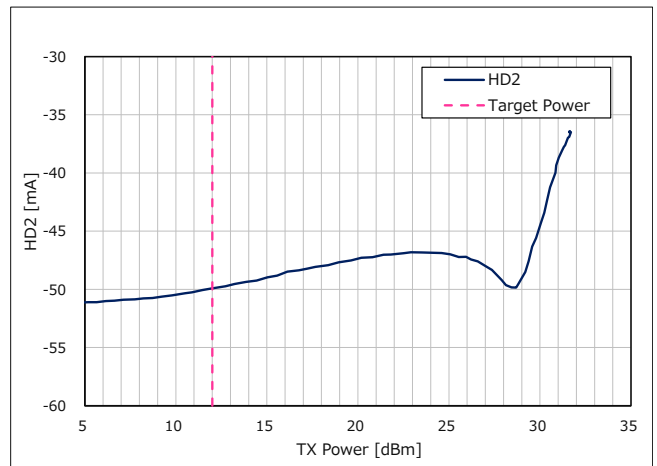

Figure 17 TX Power vs. 2nd Harmonics (Frequency = 866.5MHz)

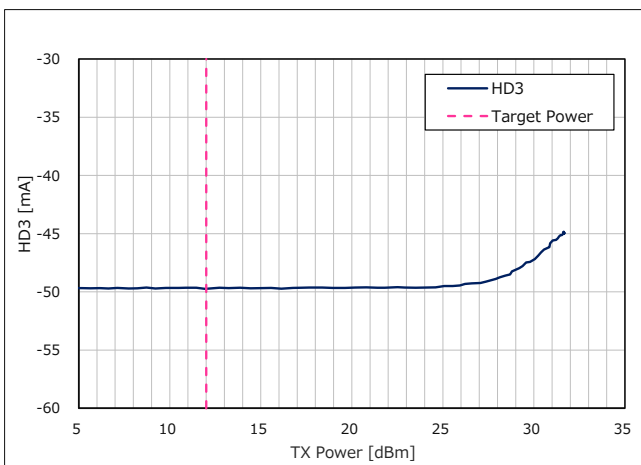

Figure 18 TX Power vs. 3rd Harmonics (Frequency = 866.5MHz)

(2) TX Radio Regulations characteristics

Signal condition: Target TX Power = +12dBm

Table 10 TX Radio Regulations characteristics (1/4)

Items		RF Frequency [MHz]	Unit	Evaluation results	Spec
TX Power		863.1	dBm	11.6	14 (*1)
		866.5		11.6	
		869.9		11.4	
Harmonics	2nd	863.1	dBm /MHz	-60.8	-30 (*1)
		866.5		-59.7	
		869.9		-58.5	
	3rd	863.1		-64.9	-30 (*1)
		866.5		-65.0	
		869.9		-65.1	
Occupied Bandwidth		863.1	kHz	107.0	-
		866.5		105.8	
		869.9		105.7	
Adjacent Channel Power Ratio (M1_Lower, 225.0 kHz offset) (*2)		863.1	dBc	-56.1	-25 (*4)
		866.5		-55.9	
		869.9		-56.0	
Adjacent Channel Power Ratio (M1_Upper, 225.0 kHz offset) (*2)		863.1	dBc	-56.2	-25 (*4)
		866.5		-56.0	
		869.9		-56.0	
Adjacent Channel Power Ratio (M2_Lower, 450.0 kHz offset) (*2)		863.1	dBc	-65.3	-35 (*4)
		866.5		-65.0	
		869.9		-65.0	
Adjacent Channel Power Ratio (M2_Upper, 450.0 kHz offset) (*2)		863.1	dBc	-65.4	-35 (*4)
		866.5		-65.3	
		869.9		-65.1	
Deviation Offset		863.1	% rms	5.8	30 (*3)
		866.5		5.6	
		869.9		5.7	
Zero Crossing Error		863.1	% pk	-2.3	±12.5 (*3)
		866.5		-2.2	
		869.9		-2.2	
Frequency tolerance (*5)		866.5	ppm	0.03	±11.5 (*1)

(*1) ETSI EN 300 220-2 V3.3.1(2018-06)

(*2) IEEE.802.15.4-2020

 M1: $1.5 \cdot R \cdot (h+1)$, M2: $3 \cdot R \cdot (h+1)$, R(symbol rate): 100kbps, h(modulation index): 0.5

(*3) Wi-SUN PHY Technical Specification - Amendment 1VA9 (11 Nov 2022). (*4) IEEE.802.15.4-2020

(*5) This characteristic depends on TCXO.

Table 11 TX Radio Regulations characteristics (2/4)

Items		RF Frequency [MHz]	Unit	Evaluation results	Spec
Unwanted emissions	9 kHz - 47 MHz	863.1	dBm /100kHz	-51.5	-36 (*1)
		866.5		-51.7	
		869.9		-50.9	
	47 MHz - 74 MHz	863.1	dBm /100kHz	-69.0	-54 (*1)
		866.5		-70.2	
		869.9		-70.0	
	74 MHz - 87.5 MHz	863.1	dBm /100kHz	-69.8	-36 (*1)
		866.5		-70.3	
		869.9		-70.9	
	87.5 MHz - 118 MHz	863.1	dBm /100kHz	-69.8	-54 (*1)
		866.5		-70.0	
		869.9		-69.8	
	118 MHz - 174 MHz	863.1	dBm /100kHz	-69.5	-36 (*1)
		866.5		-68.6	
		869.9		-69.1	
	174 MHz - 230 MHz	863.1	dBm /100kHz	-69.1	-54 (*1)
		866.5		-69.1	
		869.9		-68.9	
	230 MHz - 470 MHz	863.1	dBm /100kHz	-68.0	-36 (*1)
		866.5		-69.1	
		869.9		-69.1	
	470 MHz - 790 MHz	863.1	dBm /100kHz	-64.1	-54 (*1)
		866.5		-64.0	
		869.9		-64.5	
	790 MHz - fc-m MHz (*2)	863.1	dBm /100kHz	-58.9	-36 (*1)
		866.5		-60.0	
		869.9		-57.8	
	fc-m MHz - fc-n MHz (*2)	863.1	dBm /10kHz	-62.5	-36 (*1)
		866.5		-63.4	
		869.9		-62.2	
	fc-n MHz - fc-p MHz (*2)	863.1	dBm /kHz	-67.4	-36 (*1)
		866.5		-68.0	
		869.9		-66.0	
	fc+p MHz - fc+n MHz (*2)	863.1	dBm /kHz	-67.4	-36 (*1)
		866.5		-68.0	
		869.9		-66.0	

(*1) ETSI EN 300 220-2 V3.3.1(2018-06)

(*2) fc: Operating frequency m: 2MHz n: 0.8MHz p: 0.5MHz
m/n/p are in the case of operating channel width: 200kHz

Table 12 TX Radio Regulations characteristics (3/4)

Items		RF Frequency [MHz]	Unit	Evaluation results	Spec
Unwanted emissions	fc+n MHz - fc+m MHz (*2)	863.1	dBm /10kHz	-62.2	-36 (*1)
		866.5		-64.4	
		869.9		-64.1	
	fc+m MHz - 1 GHz (*2)	863.1	dBm /100kHz	-59.8	-36 (*1)
		866.5		-58.9	
		869.9		-57.8	
	1 GHz - 6 GHz	863.1	dBm /MHz	-51.1	-30 (*1)
		866.5		-50.7	
		869.9		-51.4	
Transient power	$\pm 0.5 \cdot \text{OCW}$ $\pm 3\text{kHz}$ (*3)	863.1	dBm /kHz	-35.7	0 (*1)
		866.5		-35.9	
		869.9		-35.4	
	$\pm \text{OCW}$ (*3)	863.1	dBm /kHz	-56.6	0 (*1)
		866.5		-56.2	
		869.9		-57.5	
	$\pm 0.5 \cdot \text{OCW}$ $\pm 400\text{kHz}$ (*3)	863.1	dBm /kHz	-67.6	-27 (*1)
		866.5		-67.6	
		869.9		-68.1	
	$\pm 0.5 \cdot \text{OCW}$ $\pm 1200\text{kHz}$ (*3)	863.1	dBm /kHz	-83.3	-27 (*1)
		866.5		-83.3	
		869.9		-83.3	

(*1) ETSI EN 300 220-2 V3.3.1(2018-06)

(*2) fc: Operating frequency m: 2MHz n: 0.8MHz p: 0.5MHz
m/n/p are in the case of operating channel width: 200kHz

(*3) OCW: 200kHz

Table 13 TX Radio Regulations characteristics (4/4)

Items		RF Frequency [MHz]	Unit	Evaluation results	Spec
Tx out of band emission (around)	$f \leq f_c - 2.5OCW$	863.1	dBm /kHz	PASS (Refer to Figure 19)	-36 (*1)
		866.5		PASS (Refer to Figure 20)	
		869.9		PASS (Refer to Figure 21)	
	$f_c - 2.5OCW \leq f < f_c - 0.5OCW$ (Margin)	863.1	dB	PASS (Refer to Figure 19)	0 (*1)
		866.5		PASS (Refer to Figure 20)	
		869.9		PASS (Refer to Figure 21)	
	$f_c + 0.5OCW < f \leq f_c + 2.5OCW$ (Margin)	863.1	dB	PASS (Refer to Figure 19)	0 (*1)
		866.5		PASS (Refer to Figure 20)	
		869.9		PASS (Refer to Figure 21)	
	$f_c + 2.5OCW \leq f$	863.1	dBm /kHz	PASS (Refer to Figure 19)	-36 (*1)
		866.5		PASS (Refer to Figure 20)	
		869.9		PASS (Refer to Figure 21)	
Tx out of band emission (Band edge)	$f \leq f_{low} - 0.4MHz$ (*2)	863.1	dBm /10kHz	PASS (Refer to Figure 22)	-36 (*1)
		866.5		PASS (Refer to Figure 23)	
		869.9		PASS (Refer to Figure 24)	
	$f_{low} - 0.4MHz < f \leq f_{low} - 0.2MHz$ (*2)	863.1	dBm /kHz	PASS (Refer to Figure 22)	-36 (*1)
		866.5		PASS (Refer to Figure 23)	
		869.9		PASS (Refer to Figure 24)	
	$f_{low} - 0.2MHz \leq f < f_{low}$ (Margin) (*2)	863.1	dB	PASS (Refer to Figure 22)	0 (*1)
		866.5		PASS (Refer to Figure 23)	
		869.9		PASS (Refer to Figure 24)	
	$f_{high} < f \leq f_{high} + 0.2MHz$ (Margin) (*2)	863.1	dB	PASS (Refer to Figure 22)	0 (*1)
		866.5		PASS (Refer to Figure 23)	
		869.9		PASS (Refer to Figure 24)	
$f_{high} + 0.2MHz < f \leq f_{high} + 0.4MHz$ (*2)	863.1	dBm /kHz	PASS (Refer to Figure 22)	-36 (*1)	
	866.5		PASS (Refer to Figure 23)		
	869.9		PASS (Refer to Figure 24)		
$f_{high} + 0.4MHz \leq f$ (*2)	863.1	dBm /10kHz	PASS (Refer to Figure 22)	-36 (*1)	
	866.5		PASS (Refer to Figure 23)		
	869.9		PASS (Refer to Figure 24)		

(*1) ETSI EN 300 220-2 V3.3.1(2018-06)

(*2) f_{low} : 863MHz f_{high} : 870MHz

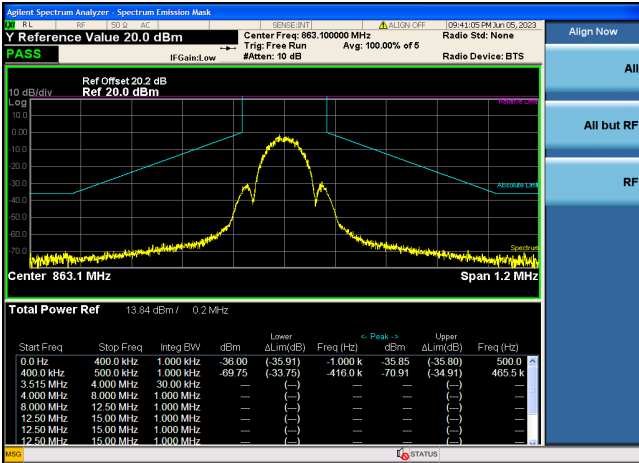

Figure 19 TX Out of Band Emissions for Operating Channel (Frequency = 863.1MHz)

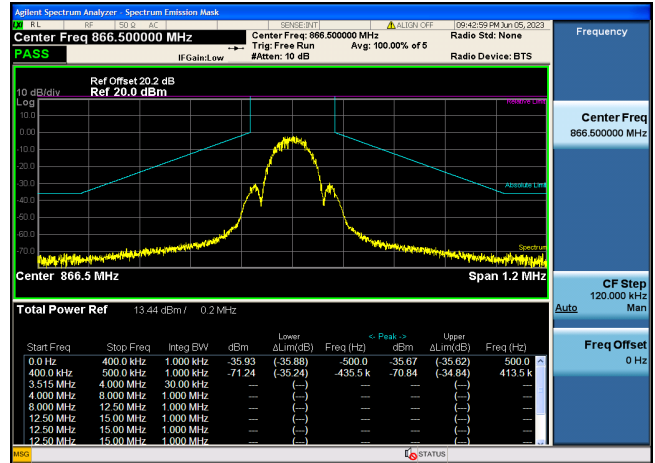

Figure 20 TX Out of Band Emissions for Operating Channel (Frequency = 866.5MHz)

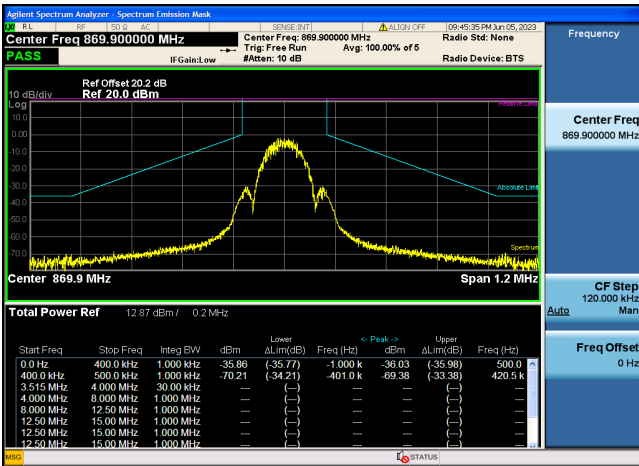

Figure 21 TX Out of Band Emissions for Operating Channel (Frequency = 869.9MHz)

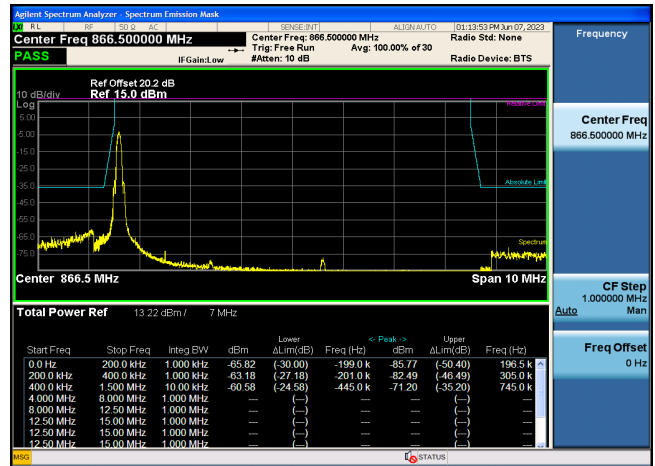

Figure 22 TX Out of Band Emissions for Operational Frequency Band (Frequency = 863.1MHz)

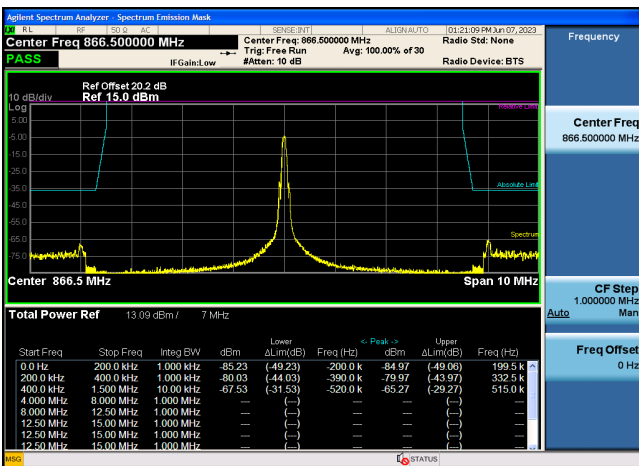

Figure 23 TX Out of Band Emissions for Operational Frequency Band (Frequency = 866.5MHz)

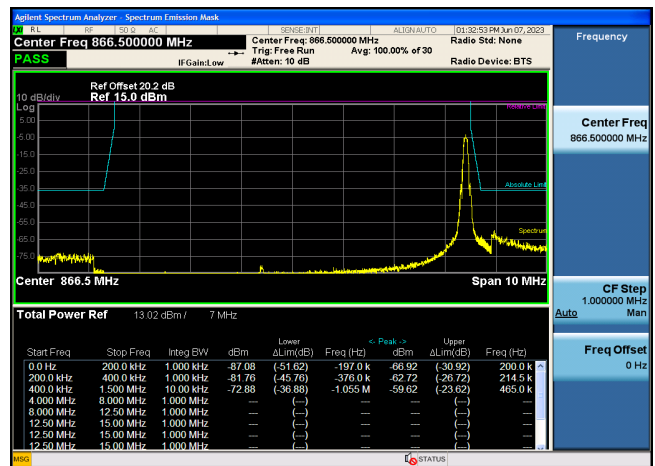

Figure 24 TX Out of Band Emissions for Operational Frequency Band (Frequency = 869.9MHz)

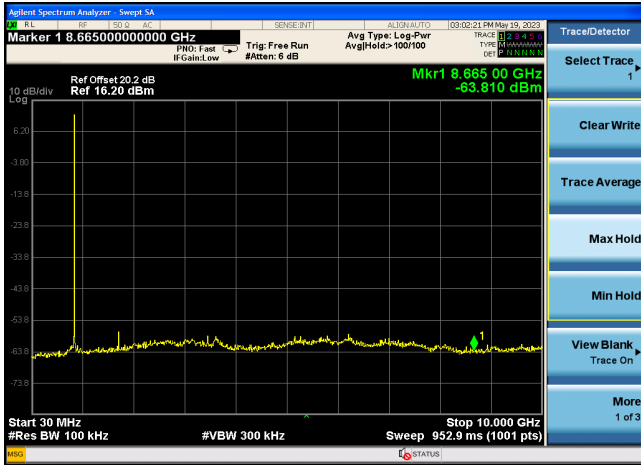

Figure 25 TX Spurious emission
(Frequency = 866.5MHz)

2.2.3 OFDM (Option4, MCS6)

(1) TX Power sweep characteristics

Signal condition: Frequency = 866.5MHz

Table 14 TX Power sweep characteristics

Items		Unit	Evaluation results
TX Power Range	Max	dBm	30.3
	Min		0.2
	Variable power range	dB	30.1
Current Range	V _{FEM}	Max	720.0
		Min	59.2
	V _{RFIC}	Max	91.6
		Min	27.9

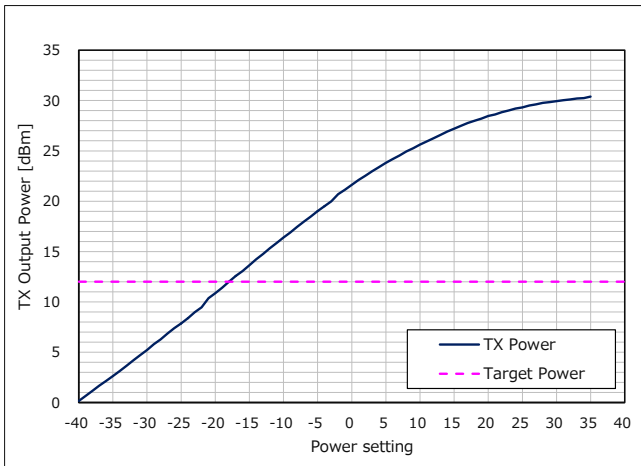

Figure 26 Power Setting vs. TX Power (Frequency = 866.5MHz)

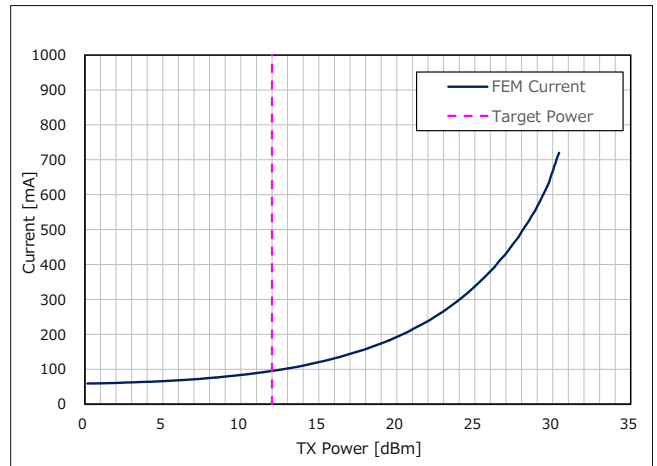

Figure 27 TX Power vs. Current of V_{FEM} for TX mode (Frequency = 866.5MHz)

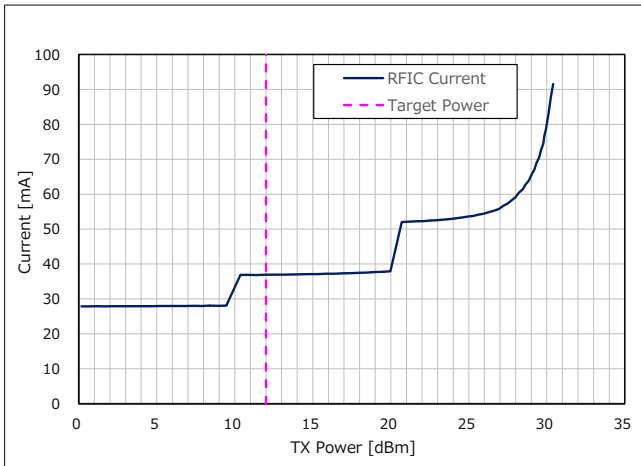

Figure 28 TX Power vs. Current of V_{RFIC} for TX mode (Frequency = 866.5MHz)

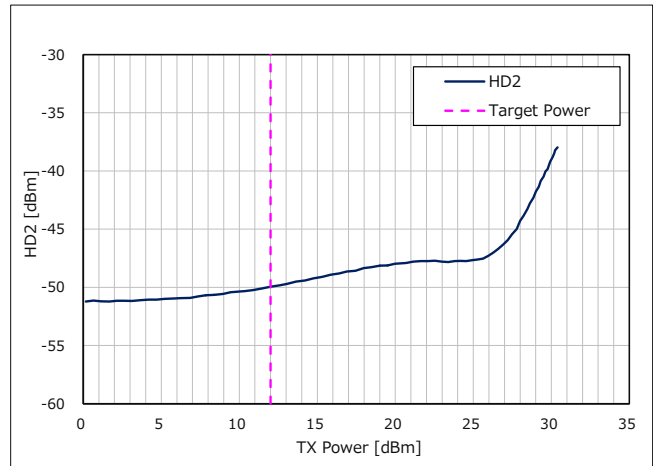

Figure 29 TX Power vs. 2nd Harmonics (Frequency = 866.5MHz)

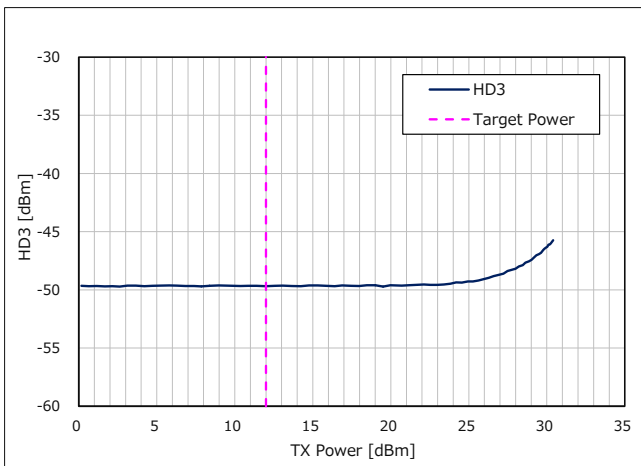

Figure 30 TX Power vs. 3rd Harmonics (Frequency = 866.5MHz)

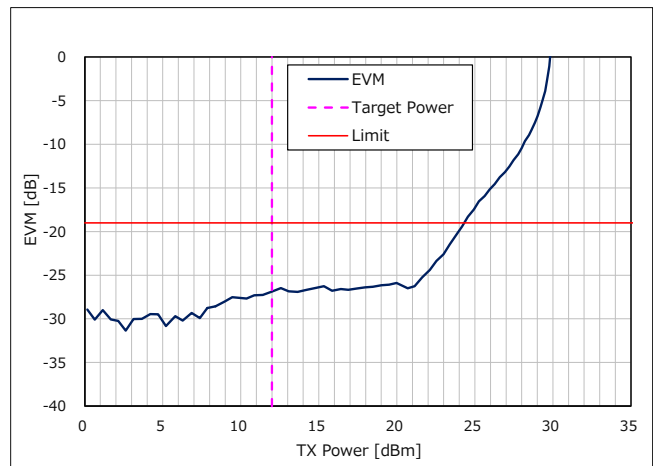

Figure 31 TX Power vs. EVM (Frequency = 866.5MHz)

(2) TX Radio Regulations characteristics

Signal condition: Target TX Power = +12dBm

Table 15 TX Radio Regulations characteristics (1/4)

Items		RF Frequency [MHz]	Unit	Evaluation results	Spec
TX Power		863.1	dBm	12.7	14 (*1)
		866.5		12.6	
		869.9		12.5	
Harmonics	2nd	863.1	dBm /MHz	-58.4	-30 (*1)
		866.5		-57.4	
		869.9		-56.8	
	3rd	863.1		-61.1	-30 (*1)
		866.5		-61.2	
		869.9		-61.3	
Occupied Bandwidth		863.1	kHz	156.9	200 (*1)
		866.5		156.5	
		869.9		157.3	
Adjacent Channel Power Ratio	Lower	863.1	dBc	-35.1	-20 (*2)
		866.5		-34.9	
		869.9		-34.8	
	Upper	863.1		-35.2	
		866.5		-35.1	
		869.9		-35.0	
Alternate Channel Power Ratio	Lower	863.1	dBc	-57.3	-40 (*2)
		866.5		-57.1	
		869.9		-56.9	
	Upper	863.1		-57.5	
		866.5		-57.5	
		869.9		-57.3	
Modulation quality	EVM	863.1	dB	-27.1	-19 (*2)
		866.5		-26.8	
		869.9		-26.3	

(*1) ETSI EN 300 220-2 V3.3.1(2018-06)

(*2) Wi-SUN PHY Technical Specification - Amendment 1VA9 (11 Nov 2022).

(*3) IEEE.802.15.4-2020

Table 16 TX Radio Regulations characteristics (2/4)

Items		RF Frequency [MHz]	Unit	Evaluation results	Spec
Unwanted emissions	9 kHz - 47 MHz	863.1	dBm /100kHz	-50.6	-36 (*1)
		866.5		-49.8	
		869.9		-50.5	
	47 MHz - 74 MHz	863.1	dBm /100kHz	-69.4	-54 (*1)
		866.5		-69.4	
		869.9		-69.9	
	74 MHz - 87.5 MHz	863.1	dBm /100kHz	-69.9	-36 (*1)
		866.5		-70.4	
		869.9		-70.3	
	87.5 MHz - 118 MHz	863.1	dBm /100kHz	-68.5	-54 (*1)
		866.5		-69.0	
		869.9		-69.0	
	118 MHz - 174 MHz	863.1	dBm /100kHz	-66.9	-36 (*1)
		866.5		-67.3	
		869.9		-67.0	
	174 MHz - 230 MHz	863.1	dBm /100kHz	-68.6	-54 (*1)
		866.5		-69.6	
		869.9		-69.2	
	230 MHz - 470 MHz	863.1	dBm /100kHz	-69.3	-36 (*1)
		866.5		-68.7	
		869.9		-69.2	
	470 MHz - 790 MHz	863.1	dBm /100kHz	-58.9	-54 (*1)
		866.5		-58.6	
		869.9		-59.8	
	790 MHz - fc-m MHz (*2)	863.1	dBm /100kHz	-51.5	-36 (*1)
		866.5		-51.3	
		869.9		-52.0	
	fc-m MHz - fc-n MHz (*2)	863.1	dBm /10kHz	-58.9	-36 (*1)
		866.5		-59.2	
		869.9		-57.8	
fc-n MHz - fc-p MHz (*2)	863.1	dBm /kHz	-62.1	-36 (*1)	
	866.5		-64.2		
	869.9		-61.9		
fc+p MHz - fc+n MHz (*2)	863.1	dBm /kHz	-64.5	-36 (*1)	
	866.5		-62.3		
	869.9		-63.1		

(*1) ETSI EN 300 220-2 V3.3.1(2018-06)

(*2) fc: Operating frequency m: 2MHz n: 0.8MHz p: 0.5MHz
m/n/p are in the case of operating channel width: 200kHz

Table 17 TX Radio Regulations characteristics (3/4)

Items		RF Frequency [MHz]	Unit	Evaluation results	Spec
Unwanted emissions	fc+n MHz - fc+m MHz (*2)	863.1	dBm /10kHz	-56.9	-36 (*1)
		866.5		-58.6	
		869.9		-58.5	
	fc+m MHz - 1 GHz (*2)	863.1	dBm /100kHz	-51.6	-36 (*1)
		866.5		-51.8	
		869.9		-51.2	
	1 GHz - 6 GHz	863.1	dBm /MHz	-47.8	-30 (*1)
		866.5		-47.6	
		869.9		-46.4	
Transient power	$\pm 0.5 \cdot \text{OCW}$ $\pm 3\text{kHz}$ (*3)	863.1	dBm /kHz	-33.9	0 (*1)
		866.5		-33.8	
		869.9		-34.2	
	$\pm \text{OCW}$ (*3)	863.1	dBm /kHz	-51.1	0 (*1)
		866.5		-50.4	
		869.9		-50.0	
	$\pm 0.5 \cdot \text{OCW}$ $\pm 400\text{kHz}$ (*3)	863.1	dBm /kHz	-70.7	-27 (*1)
		866.5		-70.6	
		869.9		-70.5	
	$\pm 0.5 \cdot \text{OCW}$ $\pm 1200\text{kHz}$ (*3)	863.1	dBm /kHz	-78.3	-27 (*1)
		866.5		-78.5	
		869.9		-78.5	

(*1) ETSI EN 300 220-2 V3.3.1(2018-06)

(*2) fc: Operating frequency m: 2MHz n: 0.8MHz p: 0.5MHz
m/n/p are in the case of operating channel width: 200kHz

(*3) OCW: 200kHz

Table 18 TX Radio Regulations characteristics (4/4)

Items		RF Frequency [MHz]	Unit	Evaluation results	Spec
Tx out of band emission (around)	$f \leq f_c - 2.5OCW$	863.1	dBm /kHz	PASS (Refer to Figure 32)	-36 (*1)
		866.5		PASS (Refer to Figure 33)	
		869.9		PASS (Refer to Figure 34)	
	$f_c - 2.5OCW \leq f < f_c - 0.5OCW$ (Margin)	863.1	dB	PASS (Refer to Figure 32)	0 (*1)
		866.5		PASS (Refer to Figure 33)	
		869.9		PASS (Refer to Figure 34)	
	$f_c + 0.5OCW < f \leq f_c + 2.5OCW$ (Margin)	863.1	dB	PASS (Refer to Figure 32)	0 (*1)
		866.5		PASS (Refer to Figure 33)	
		869.9		PASS (Refer to Figure 34)	
	$f_c + 2.5OCW \leq f$	863.1	dBm /kHz	PASS (Refer to Figure 32)	-36 (*1)
		866.5		PASS (Refer to Figure 33)	
		869.9		PASS (Refer to Figure 34)	
Tx out of band emission (Band edge)	$f \leq f_{low} - 0.4MHz$ (*2)	863.1	dBm /10kHz	PASS (Refer to Figure 35)	-36 (*1)
		866.5		PASS (Refer to Figure 36)	
		869.9		PASS (Refer to Figure 37)	
	$f_{low} - 0.4MHz < f \leq f_{low} - 0.2MHz$ (*2)	863.1	dBm /kHz	PASS (Refer to Figure 35)	-36 (*1)
		866.5		PASS (Refer to Figure 36)	
		869.9		PASS (Refer to Figure 37)	
	$f_{low} - 0.2MHz \leq f < f_{low}$ (Margin) (*2)	863.1	dB	PASS (Refer to Figure 35)	0 (*1)
		866.5		PASS (Refer to Figure 36)	
		869.9		PASS (Refer to Figure 37)	
	$f_{high} < f \leq f_{high} + 0.2MHz$ (Margin) (*2)	863.1	dB	PASS (Refer to Figure 35)	0 (*1)
		866.5		PASS (Refer to Figure 36)	
		869.9		PASS (Refer to Figure 37)	
	$f_{high} + 0.2MHz < f \leq f_{high} + 0.4MHz$ (*2)	863.1	dBm /kHz	PASS (Refer to Figure 35)	-36 (*1)
		866.5		PASS (Refer to Figure 36)	
		869.9		PASS (Refer to Figure 37)	
	$f_{high} + 0.4MHz \leq f$ (*2)	863.1	dBm /10kHz	PASS (Refer to Figure 35)	-36 (*1)
		866.5		PASS (Refer to Figure 36)	
		869.9		PASS (Refer to Figure 37)	

(*1) ETSI EN 300 220-2 V3.3.1(2018-06)

(*2) f_{low} : 863MHz f_{high} : 870MHz

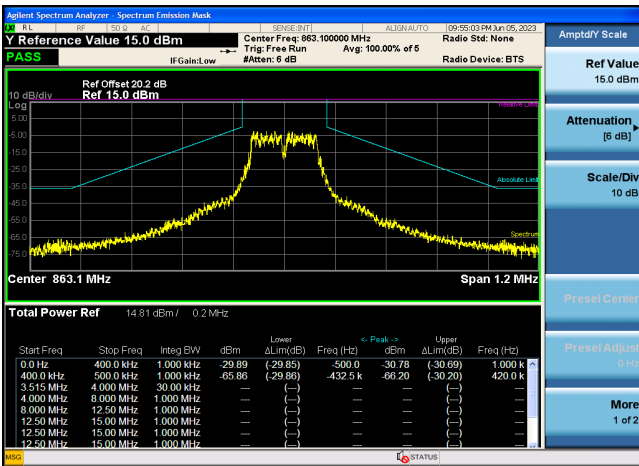

Figure 32 TX Out of Band Emissions for Operating Channel (Frequency = 863.1MHz)

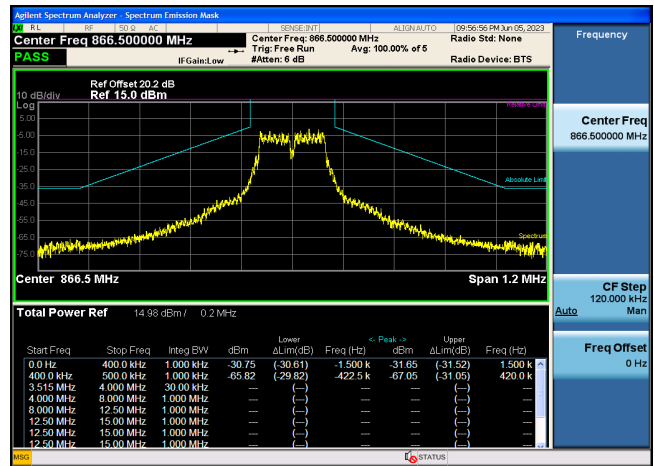

Figure 33 TX Out of Band Emissions for Operating Channel (Frequency = 866.5MHz)

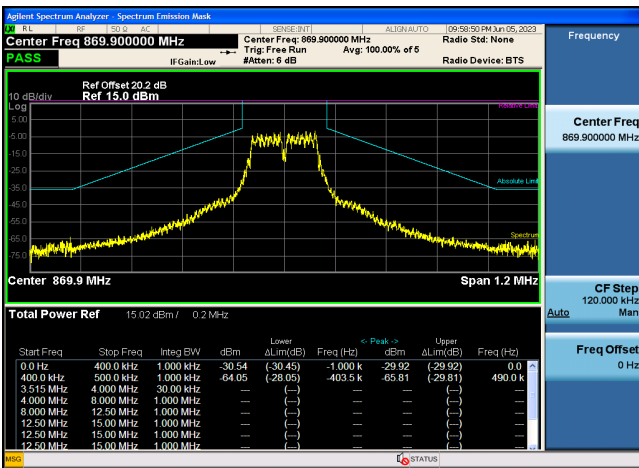

Figure 34 TX Out of Band Emissions for Operating Channel (Frequency = 869.9MHz)

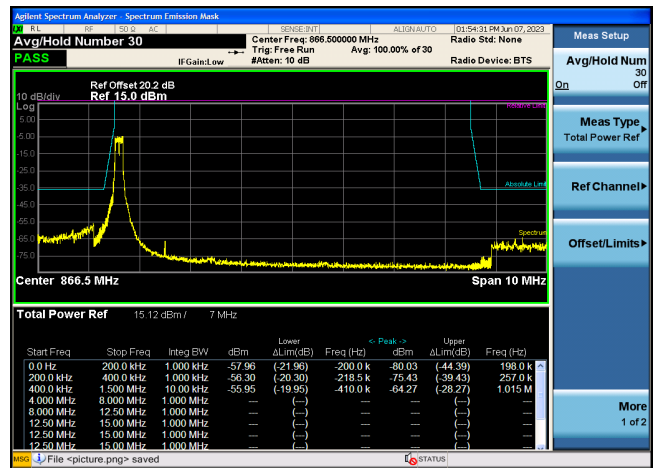

Figure 35 TX Out of Band Emissions for Operational Frequency Band (Frequency = 863.1MHz)

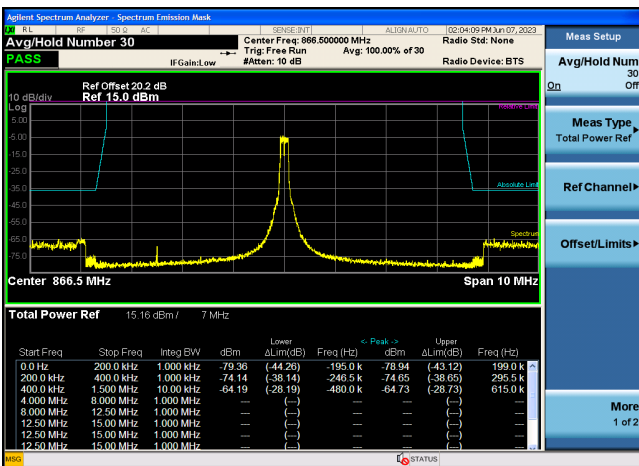

Figure 36 TX Out of Band Emissions for Operational Frequency Band (Frequency = 866.5MHz)

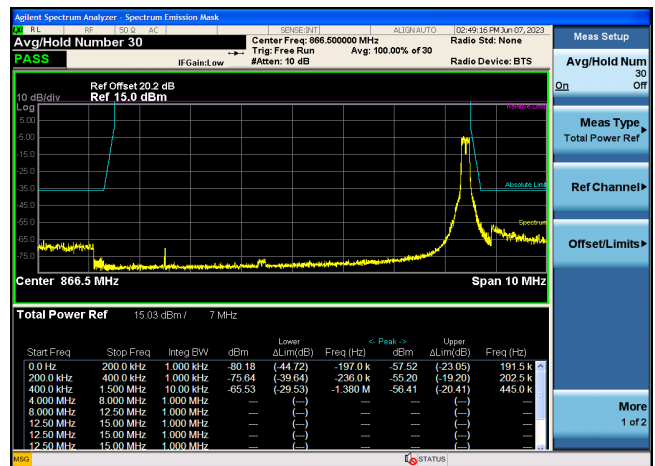

Figure 37 TX Out of Band Emissions for Operational Frequency Band (Frequency = 869.9MHz)

2.3 RX Electrical Characteristics

2.3.1 FSK (50kbps, modulation index = 0.5)

Table 19 RX Electrical Characteristics 1

Items			RF Frequency [MHz]	Unit	Evaluation result	Spec
Receiver sensitivity	PER < 10% Length 250 octets		863.1	dBm	-110	-91 (*4)
			866.5		-111	
			869.9		-111	
Maximum Input level	PER < 10% Length 250 octets		863.1	dBm	10	-
			866.5		10	
			869.9		10	
RSSI accuracy	Average	RSSI range: -111dBm to -21dBm (*1)	863.1	dB	1.0	-
			866.5		1.0	
			869.9		1.0	
	MAX		863.1		1.0	
			866.5		1.0	
			869.9		1.0	
	MIN		863.1		-1.0	
			866.5		-1.0	
			869.9		-1.0	
ED accuracy	Average	ED range: -111dBm to -21dBm (*1)	863.1	dB	-2.0	-
			866.5		-2.0	
			869.9		-2.0	
	MAX		863.1		-2.0	
			866.5		-2.0	
			869.9		-2.0	
	MIN		863.1		-2.0	
			866.5		-2.0	
			869.9		-2.0	
Frequency tolerance	Max	PER < 10% Length 250 octets	866.5	ppm	30	±20
	Min				-30	
Adjacent channel rejection	-100kHz	PER < 10% (*2) (*3) Length 250 octets	866.5	dB	34	10 (*4)
	+100kHz				35	
Alternate channel rejection	-200kHz	PER < 10% (*2) (*3) Length 250 octets	866.5	dB	41	30 (*4)
	+200kHz				40	
Co channel rejection	±0MHz	PER < 10% (*2) (*3) Length 250 octets	866.5	dB	-8.0	-
Blocking	+1MHz	PER < 10% (*2) (*3) Length 250 octets	866.5	dB	62	-
	-2MHz				63	
	+2MHz				63	
	-10MHz				68	
	+10MHz				69	
Image rejection	-1.1MHz	PER < 10% (*2) (*3) Length 250 octets	866.5	dB	43	-
Receiver spurious emission	9kHz - 1000MHz		863.1	dBm /100kHz	-68.3	-57 (*5)
			866.5		-68.8	
			869.9		-68.4	
	1 - 6GHz		863.1	dBm /MHz	-58.6	-47 (*5)
			866.5		-58.6	
			869.9		-58.6	

(*1) Lower limit: RX sensitivity / Upper limit: Limit described in the user's manual (-5dBm) - FEM LNA gain (16dB).

(*2) The level of the desired signal: RX sensitivity + 3dB (-108dBm)

(*3) Interference signal is non-modulated wave. (*4) IEEE.802.15.4-2020. (*5) ETSI EN 300 220-2 V3.3.1(2018-06)

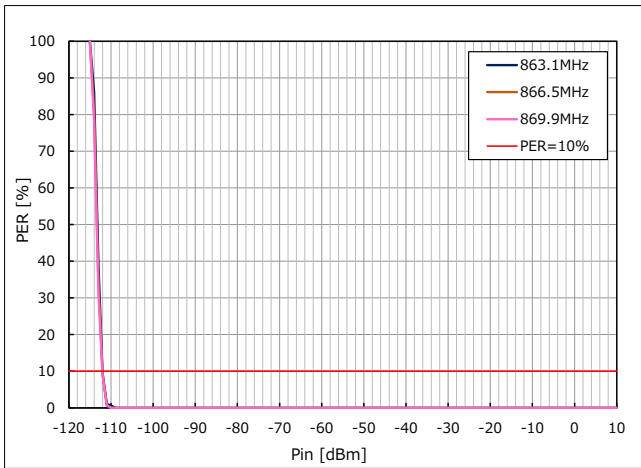

Figure 38 RF Input Level vs. Packet Error Rate
(Frequency = 863.1 / 866.5 / 869.9MHz)

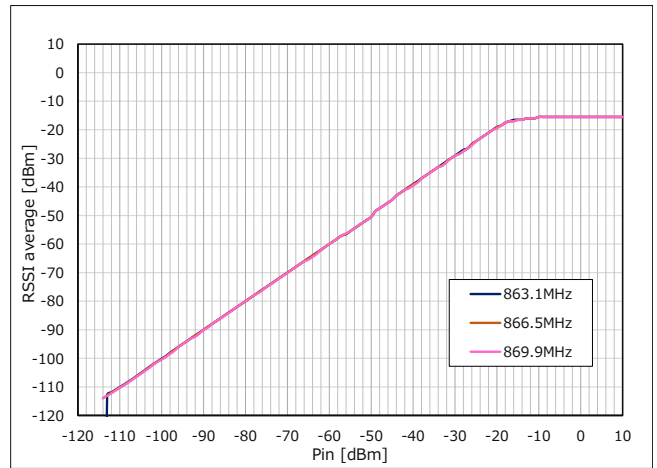

Figure 39 RF Input Level vs. RSSI average
(Frequency = 863.1 / 866.5 / 869.9MHz)

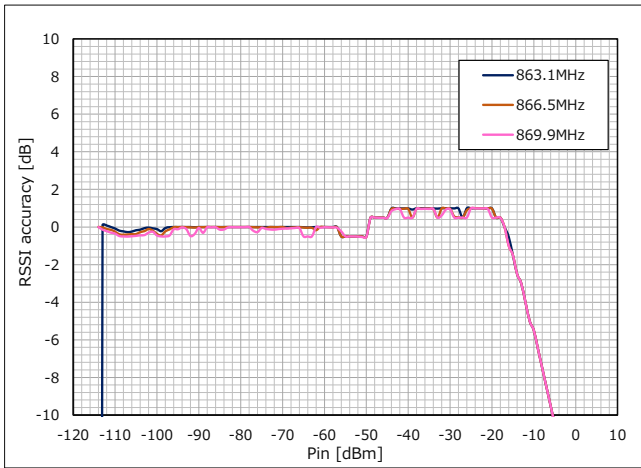

Figure 40 RF Input Level vs. RSSI accuracy
(Frequency = 863.1 / 866.5 / 869.9MHz)

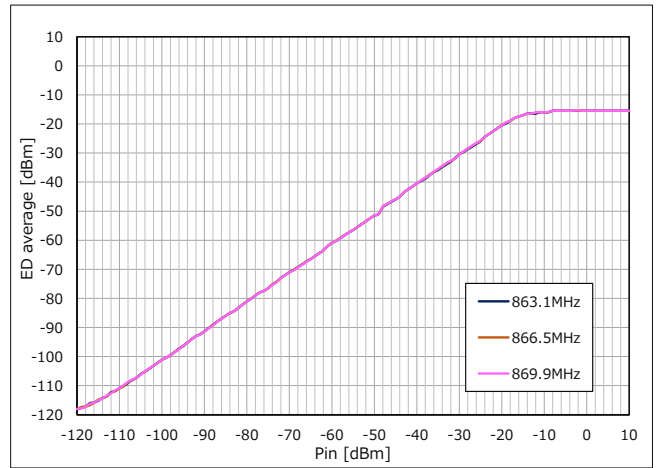

Figure 41 RF Input Level vs. ED average
(Frequency = 863.1 / 866.5 / 869.9MHz)

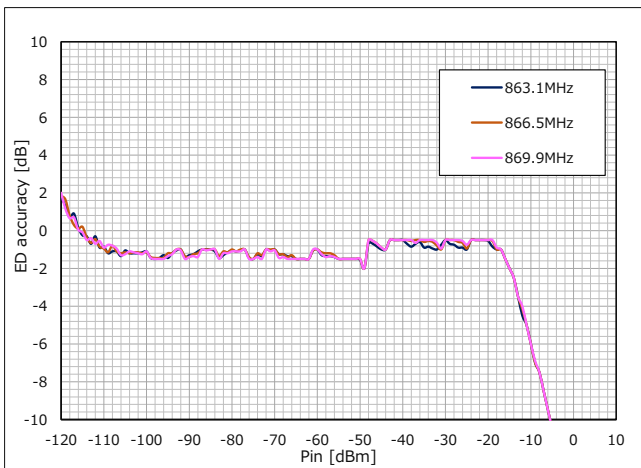

Figure 42 RF Input Level vs. ED accuracy
(Frequency = 863.1 / 866.5 / 869.9MHz)

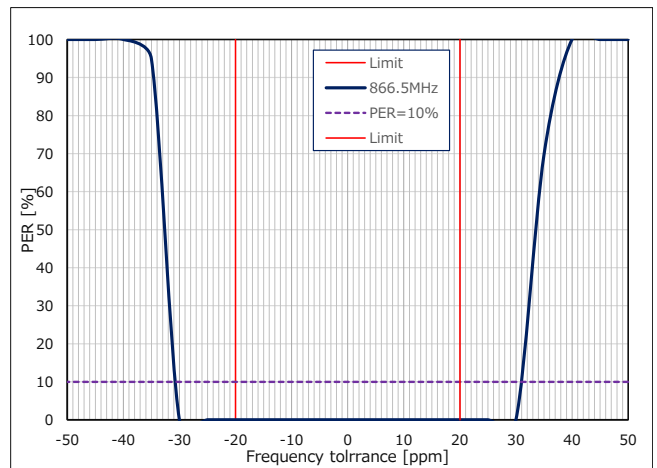

Figure 43 RF Frequency tolerance vs. Packet Error Rate
(Frequency = 866.5MHz)

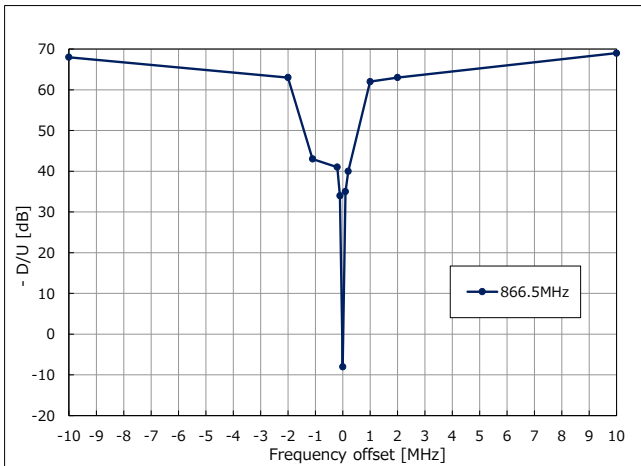

Figure 44 RF Frequency offset vs. Desire/Unwanted Signal Ratio (Frequency = 866.5MHz)

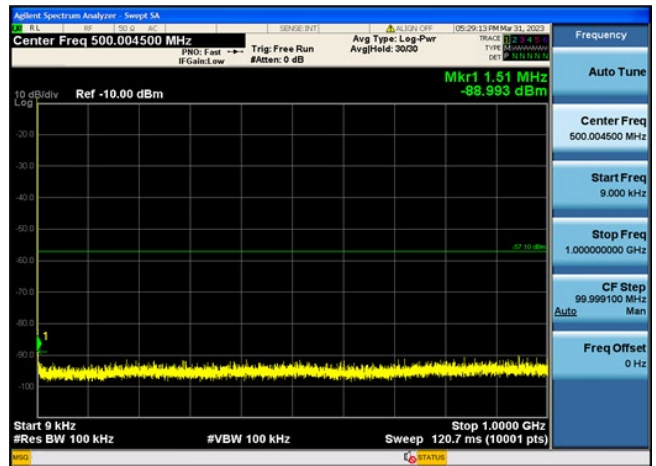

Figure 45 Receiver spurious emission (9kHz -1GHz) (Frequency = 866.5MHz)

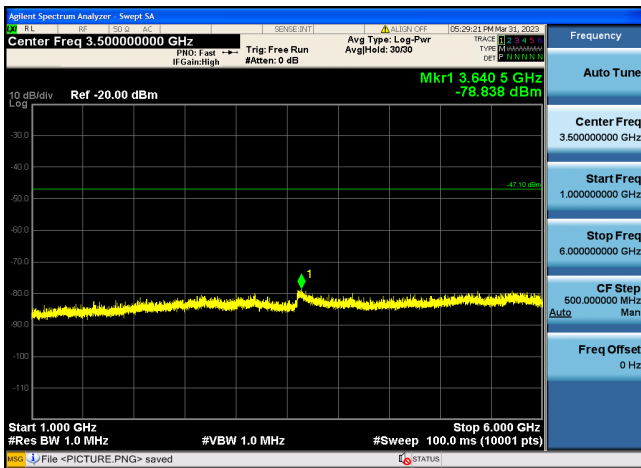

Figure 46 Receiver spurious emission (1GHz -6GHz) (Frequency = 866.5MHz)

2.3.2 FSK (100kbps, modulation index = 0.5)
Table 20 RX Electrical Characteristics 2

Items			RF Frequency [MHz]	Unit	Evaluation result	Spec
Receiver sensitivity	PER < 10% Length 250 octets		863.1	dBm	-107	-88 (*4)
			866.5		-108	
			869.9		-108	
Maximum Input level	PER < 10% Length 250 octets		863.1	dBm	10	-
			866.5		10	
			869.9		10	
RSSI accuracy	Average	RSSI range: -108dBm to -21dBm (*1)	863.1	dB	1.0	-
			866.5		1.0	
			869.9		1.0	
	MAX		863.1		1.0	
			866.5		1.0	
			869.9		1.0	
	MIN		863.1		-0.5	
			866.5		-1.0	
			869.9		-1.0	
ED accuracy	Average	ED range: -108dBm to -21dBm (*1)	863.1	dB	-1.5	-
			866.5		-1.5	
			869.9		-1.5	
	MAX		863.1		-1.5	
			866.5		-1.5	
			869.9		-1.5	
	MIN		863.1		-1.5	
			866.5		-1.5	
			869.9		-1.5	
Frequency tolerance	Max	PER < 10% Length 250 octets	866.5	ppm	≥ 50	±20
	Min				≤ -50	
Adjacent channel rejection	-200kHz	PER < 10% (*2) (*3) Length 250 octets	866.5	dB	34	10 (*4)
	+200kHz				36	
Alternate channel rejection	-400kHz	PER < 10% (*2) (*3) Length 250 octets	866.5	dB	48	30 (*4)
	+400kHz				49	
Co channel rejection	±0MHz	PER < 10% (*2) (*3) Length 250 octets	866.5	dB	-8	-
Blocking	+1MHz	PER < 10% (*2) (*3) Length 250 octets	866.5	dB	59	-
	-2MHz				60	
	+2MHz				60	
	-10MHz				64	
	+10MHz				61	
Image rejection	-1.1MHz	PER < 10% (*2) (*3) Length 250 octets	866.5	dB	42	-
Receiver spurious emission	9kHz - 1000MHz		863.1	dBm /100kHz	-68.1	-57 (*5)
			866.5		-67.9	
			869.9		-67.7	
	1 - 6GHz		863.1	dBm /MHz	-58.2	-47 (*5)
			866.5		-57.5	
			869.9		-58.4	

(*1) Lower limit: RX sensitivity / Upper limit: Limit described in the user's manual (-5dBm) - FEM LNA gain (16dB).

(*2) The level of the desired signal: RX sensitivity + 3dB (-105dBm)

(*3) Interference signal is non-modulated wave. (*4) IEEE.802.15.4-2020. (*5) ETSI EN 300 220-2 V3.3.1(2018-06)

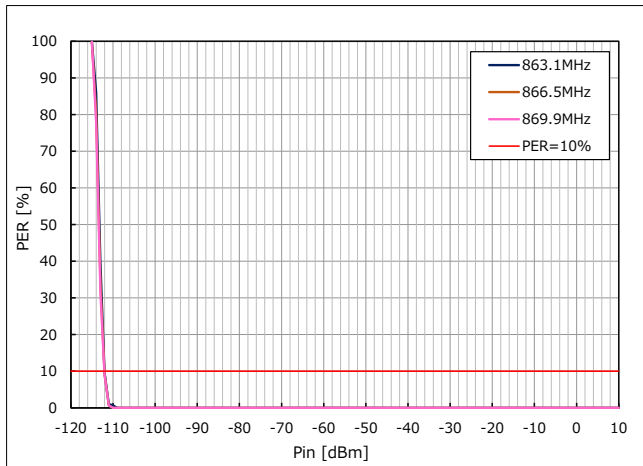

Figure 47 RF Input Level vs. Packet Error Rate (Frequency = 863.1 / 866.5 / 869.9MHz)

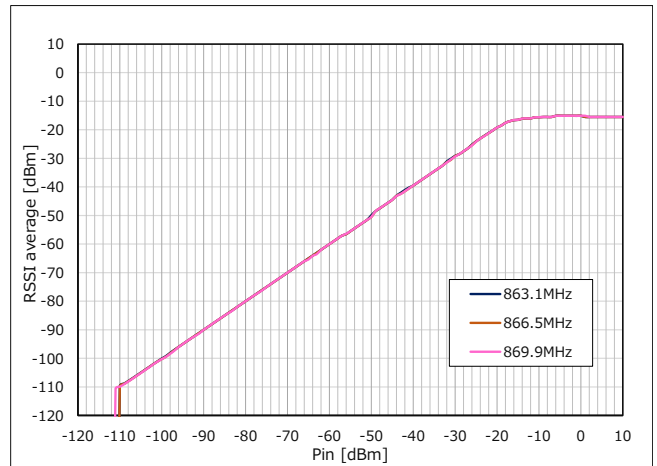

Figure 48 RF Input Level vs. RSSI average (Frequency = 863.1 / 866.5 / 869.9MHz)

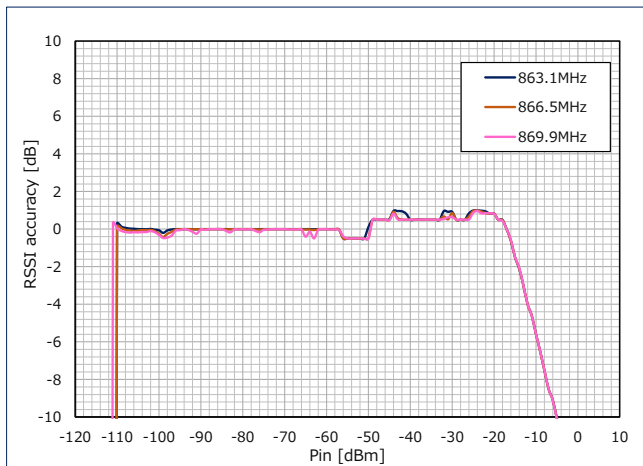

Figure 49 RF Input Level vs. RSSI accuracy (Frequency = 863.1 / 866.5 / 869.9MHz)

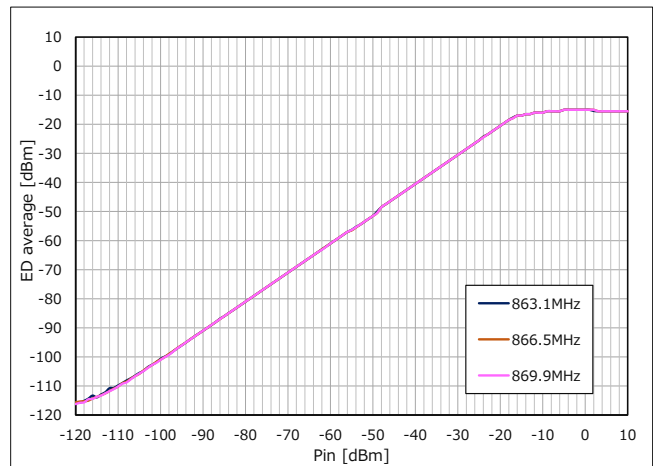

Figure 50 RF Input Level vs. ED average (Frequency = 863.1 / 866.5 / 869.9MHz)

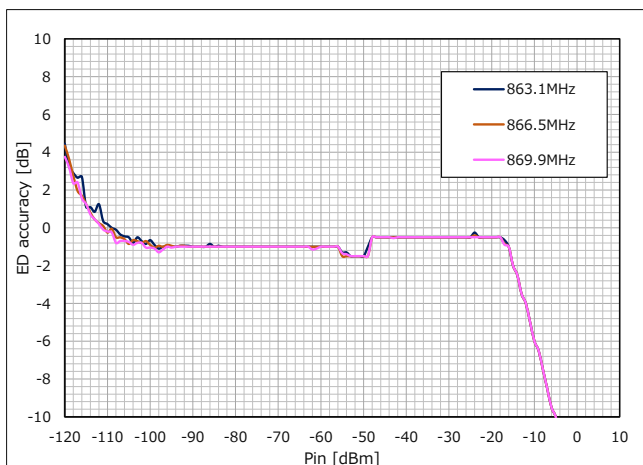

Figure 51 RF Input Level vs. ED accuracy (Frequency = 863.1 / 866.5 / 869.9MHz)

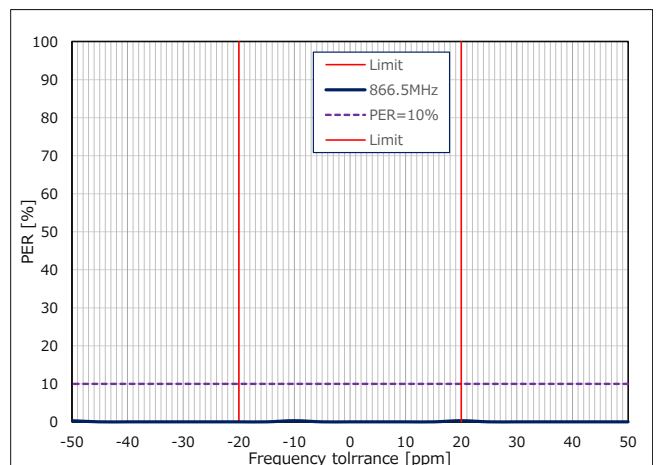

Figure 52 RF Frequency tolerance vs. Packet Error Rate (Frequency = 866.5MHz)

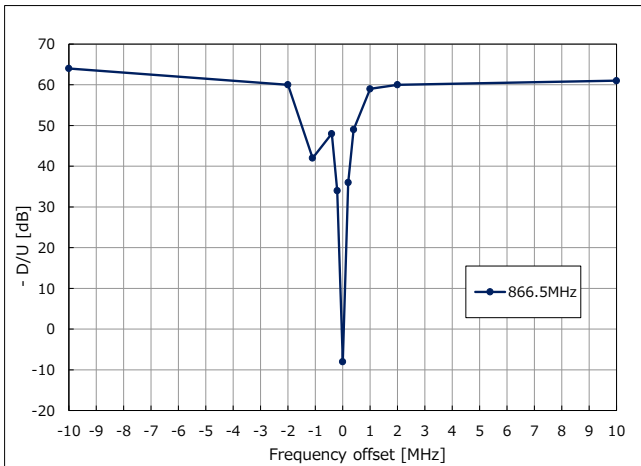

Figure 53 RF Frequency offset vs. Desire/Unwanted Signal Ratio (Frequency = 866.5MHz)

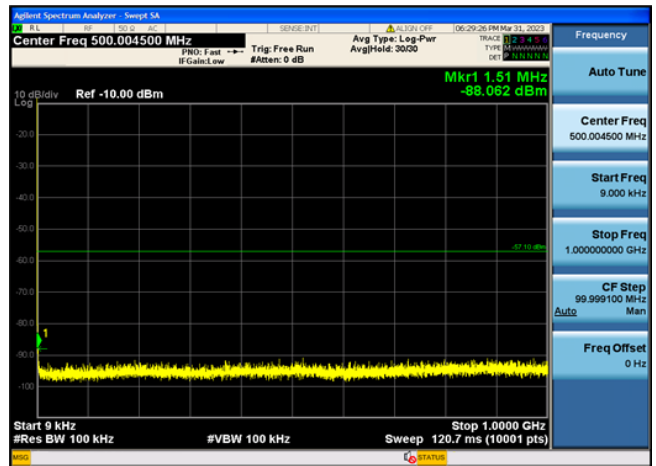

Figure 54 Receiver spurious emission (9kHz -1GHz) (Frequency = 866.5MHz)

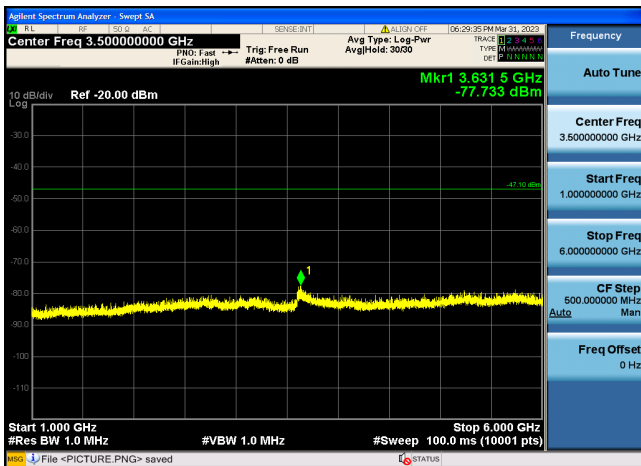

Figure 55 Receiver spurious emission (1GHz -6GHz) (Frequency = 866.5MHz)

2.3.3 OFDM (Option4, MCS6)

Table 21 RX Electrical Characteristics 3

Items		RF Frequency [MHz]	Unit	Evaluation result	Spec	
Receiver sensitivity	PER < 10% Length 250 octets	863.1	dBm	-105	-94 (*6)	
		866.5		-106		
		869.9		-106		
Maximum Input level	PER < 10% Length 250 octets	863.1	dBm	-15	-	
		866.5		-15		
		869.9		-15		
RSSI accuracy	Average	863.1	dB	-1.0	-	
		866.5		-1.0		
		869.9		-1.0		
	MAX	863.1		-1.0		
		866.5		-1.0		
		869.9		-1.0		
	MIN	863.1		-1.5		
		866.5		-1.5		
		869.9		-1.0		
ED accuracy	Average	863.1	dB	-2.0	-	
		866.5		-2.0		
		869.9		-2.2		
	MAX	863.1		-2.0		
		866.5		-2.0		
		869.9		-2.0		
	MIN	863.1		-2.0		
		866.5		-2.0		
		869.9		-2.5		
Frequency tolerance	Max	PER < 10% Length 250 octets	866.5	ppm	-45	±20
	Min					
Adjacent channel rejection	-200kHz	PER < 10% (*2) (*3) (*5) Length 250 octets	866.5	dB	29	2 (*7)
	+200kHz				26	
Alternate channel rejection	-400kHz	PER < 10% (*2) (*3) (*5) Length 250 octets	866.5	dB	36	26 (*7)
	+400kHz				34	
Co channel rejection	±0MHz	PER < 10% (*2) (*4) (*5) Length 250 octets	866.5	dB	-16	-23 (*7)
Blocking	+1MHz	PER < 10% (*2) (*3) (*5) Length 250 octets	866.5	dB	25	-
	-2MHz				52	
	+2MHz				51	
	-10MHz				52	
	+10MHz				52	
Image rejection	-1.1MHz	PER < 10% (*2) (*3) (*5) Length 250 octets	866.5	dB	28	-
Receiver spurious emission	9kHz - 1000MHz	863.1	dBm /100kHz	-67.2	-57 (*8)	
		866.5		-68.2		
		869.9		-68.1		
	1 - 6GHz	863.1	dBm /MHz	-58.1	-47 (*8)	
		866.5		-58.1		
		869.9		-58.7		

(*1) Lower limit: RX sensitivity / Upper limit: Limit described in the user's manual (-5dBm) - FEM LNA gain (16dB).

(*2) The level of the desired signal: RX sensitivity + 3dB (-103dBm)

(*3) Interference signal pattern defined by the certification body. (*4) Interference signal pattern without LTF and STF defined by Wi-SUN. (*5) Interference signal is modulated wave. (*6) IEEE.802.15.4-2020.

(*7) Wi-SUN PHY Technical Specification - Amendment 1VA9 (11 Nov 2022).

(*8) ETSI EN 300 220-2 V3.3.1(2018-06).

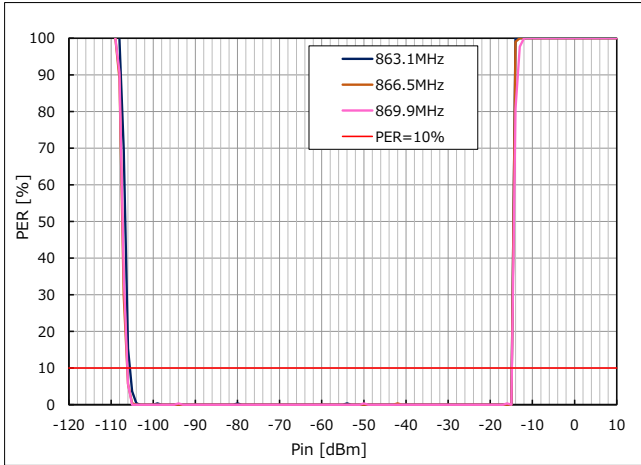

Figure 56 RF Input Level vs. Packet Error Rate
(Frequency = 863.1 / 866.5 / 869.9MHz)

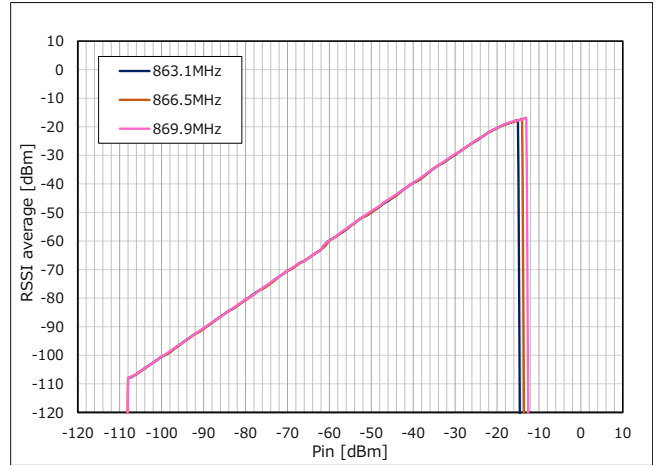

Figure 57 RF Input Level vs. RSSI average
(Frequency = 863.1 / 866.5 / 869.9MHz)

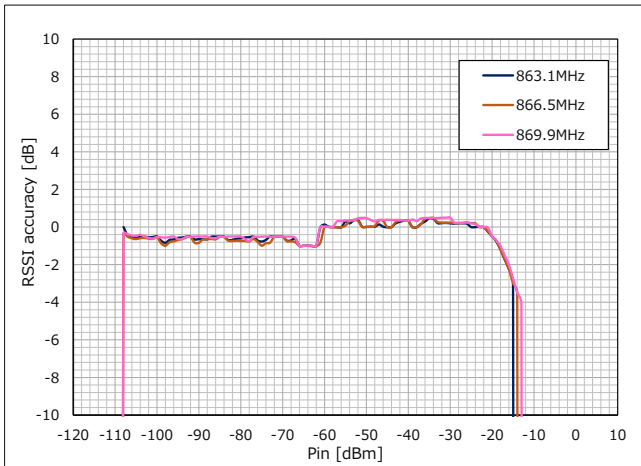

Figure 58 RF Input Level vs. RSSI accuracy
(Frequency = 863.1 / 866.5 / 869.9MHz)

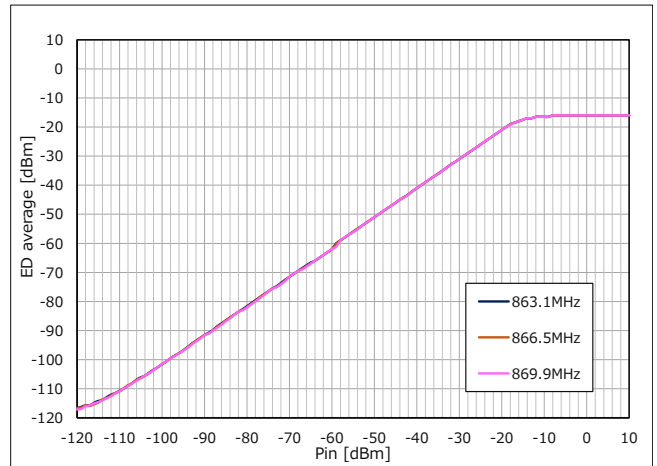

Figure 59 RF Input Level vs. ED average
(Frequency = 863.1 / 866.5 / 869.9MHz)

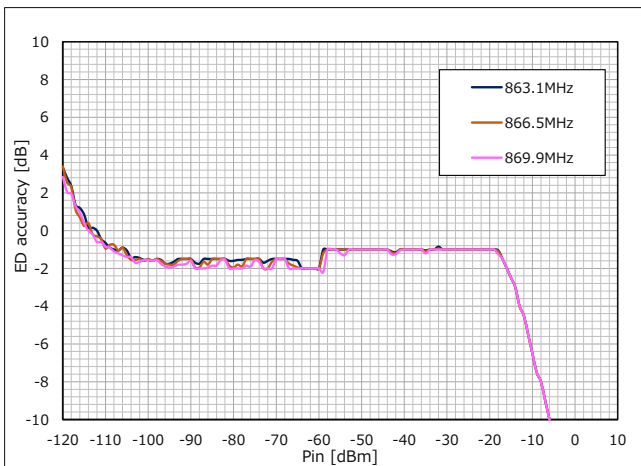

Figure 60 RF Input Level vs. ED accuracy
(Frequency = 863.1 / 866.5 / 869.9MHz)

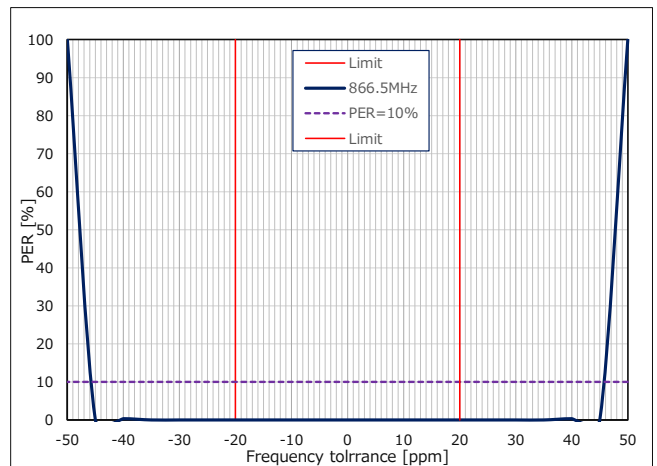

Figure 61 RF Frequency tolerance vs. Packet Error Rate
(Frequency = 866.5MHz)

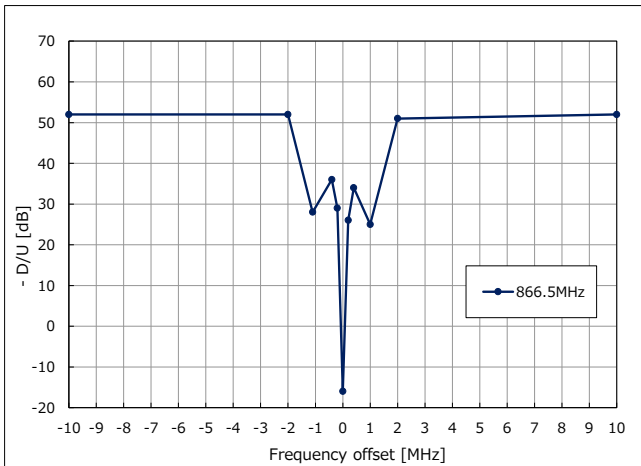

Figure 62 RF Frequency offset vs. Desire/Unwanted Signal Ratio (Frequency = 866.5MHz)

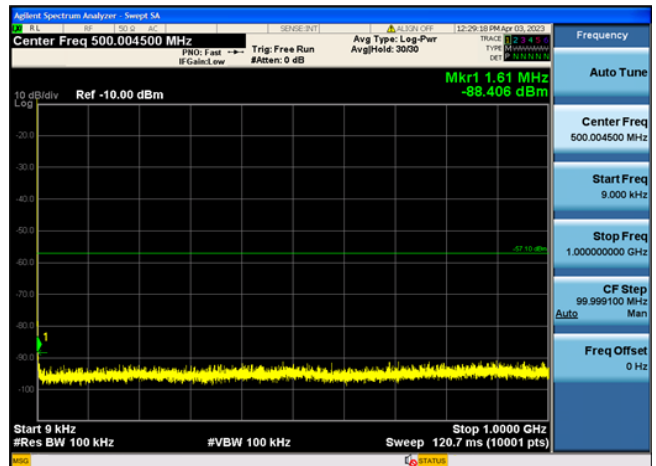

Figure 63 Receiver spurious emission (9kHz -1GHz) (Frequency = 866.5MHz)

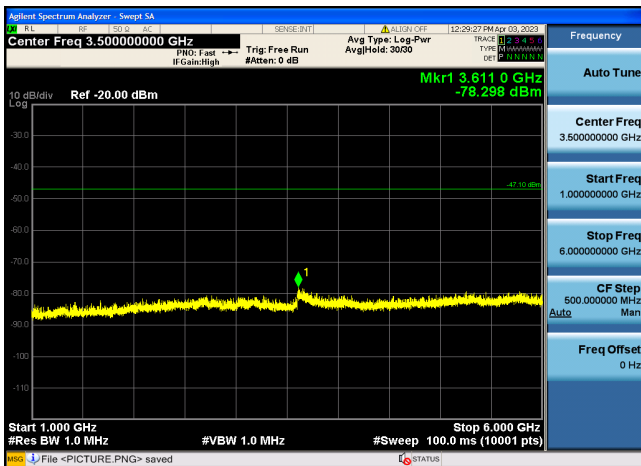

Figure 64 Receiver spurious emission (1GHz -6GHz) (Frequency = 866.5MHz)

3. Detailed information on the Evaluation Kit

The user's manual and design data for the Evaluation Kit can be viewed at the following URL.

RTK0EE0013D10002BJ

<https://www.renesas.com/us/en/products/wireless-connectivity/sub-ghz-wi-sun-transceivers/rtk0ee0013d10002bj-r9a06g062gnp-ceukca-compliant-sub-ghz-wireless-communication-evaluation-kit>

Revision History

Rev.	Date	Description	
		Page	Summary
1.00	JUN.23.2023	-	First edition issued

General Precautions in the Handling of Microprocessing Unit and Microcontroller Unit Products

The following usage notes are applicable to all Microprocessing unit and Microcontroller unit products from Renesas. For detailed usage notes on the products covered by this document, refer to the relevant sections of the document as well as any technical updates that have been issued for the products.

1. Precaution against Electrostatic Discharge (ESD)

A strong electrical field, when exposed to a CMOS device, can cause destruction of the gate oxide and ultimately degrade the device operation. Steps must be taken to stop the generation of static electricity as much as possible, and quickly dissipate it when it occurs. Environmental control must be adequate. When it is dry, a humidifier should be used. This is recommended to avoid using insulators that can easily build up static electricity.

Semiconductor devices must be stored and transported in an anti-static container, static shielding bag or conductive material. All test and measurement tools including work benches and floors must be grounded. The operator must also be grounded using a wrist strap. Semiconductor devices must not be touched with bare hands. Similar precautions must be taken for printed circuit boards with mounted semiconductor devices.

2. Processing at power-on

The state of the product is undefined at the time when power is supplied. The states of internal circuits in the LSI are indeterminate and the states of register settings and pins are undefined at the time when power is supplied. In a finished product where the reset signal is applied to the external reset pin, the states of pins are not guaranteed from the time when power is supplied until the reset process is completed. In a similar way, the states of pins in a product that is reset by an on-chip power-on reset function are not guaranteed from the time when power is supplied until the power reaches the level at which resetting is specified.

3. Input of signal during power-off state

Do not input signals or an I/O pull-up power supply while the device is powered off. The current injection that results from input of such a signal or I/O pull-up power supply may cause malfunction and the abnormal current that passes in the device at this time may cause degradation of internal elements. Follow the guideline for input signal during power-off state as described in your product documentation.

4. Handling of unused pins

Handle unused pins in accordance with the directions given under handling of unused pins in the manual. The input pins of CMOS products are generally in the high-impedance state. In operation with an unused pin in the open-circuit state, extra electromagnetic noise is induced in the vicinity of the LSI, an associated shoot-through current flows internally, and malfunctions occur due to the false recognition of the pin state as an input signal become possible.

5. Clock signals

After applying a reset, only release the reset line after the operating clock signal becomes stable. When switching the clock signal during program execution, wait until the target clock signal is stabilized. When the clock signal is generated with an external resonator or from an external oscillator during a reset, ensure that the reset line is only released after full stabilization of the clock signal. Additionally, when switching to a clock signal produced with an external resonator or by an external oscillator while program execution is in progress, wait until the target clock signal is stable.

6. Voltage application waveform at input pin

Waveform distortion due to input noise or a reflected wave may cause malfunction. If the input of the CMOS device stays in the area between V_{IL} (Max.) and V_{IH} (Min.) due to noise, for example, the device may malfunction. Take care to prevent chattering noise from entering the device when the input level is fixed, and also in the transition period when the input level passes through the area between V_{IL} (Max.) and V_{IH} (Min.).

7. Prohibition of access to reserved addresses

Access to reserved addresses is prohibited. The reserved addresses are provided for possible future expansion of functions. Do not access these addresses as the correct operation of the LSI is not guaranteed.

8. Differences between products

Before changing from one product to another, for example to a product with a different part number, confirm that the change will not lead to problems. The characteristics of a microprocessing unit or microcontroller unit products in the same group but having a different part number might differ in terms of internal memory capacity, layout pattern, and other factors, which can affect the ranges of electrical characteristics, such as characteristic values, operating margins, immunity to noise, and amount of radiated noise. When changing to a product with a different part number, implement a system-evaluation test for the given product.

Notice

1. Descriptions of circuits, software and other related information in this document are provided only to illustrate the operation of semiconductor products and application examples. You are fully responsible for the incorporation or any other use of the circuits, software, and information in the design of your product or system. Renesas Electronics disclaims any and all liability for any losses and damages incurred by you or third parties arising from the use of these circuits, software, or information.
2. Renesas Electronics hereby expressly disclaims any warranties against and liability for infringement or any other claims involving patents, copyrights, or other intellectual property rights of third parties, by or arising from the use of Renesas Electronics products or technical information described in this document, including but not limited to, the product data, drawings, charts, programs, algorithms, and application examples.
3. No license, express, implied or otherwise, is granted hereby under any patents, copyrights or other intellectual property rights of Renesas Electronics or others.
4. You shall be responsible for determining what licenses are required from any third parties, and obtaining such licenses for the lawful import, export, manufacture, sales, utilization, distribution or other disposal of any products incorporating Renesas Electronics products, if required.
5. You shall not alter, modify, copy, or reverse engineer any Renesas Electronics product, whether in whole or in part. Renesas Electronics disclaims any and all liability for any losses or damages incurred by you or third parties arising from such alteration, modification, copying or reverse engineering.
6. Renesas Electronics products are classified according to the following two quality grades: "Standard" and "High Quality". The intended applications for each Renesas Electronics product depends on the product's quality grade, as indicated below.
 - "Standard": Computers; office equipment; communications equipment; test and measurement equipment; audio and visual equipment; home electronic appliances; machine tools; personal electronic equipment; industrial robots; etc.
 - "High Quality": Transportation equipment (automobiles, trains, ships, etc.); traffic control (traffic lights); large-scale communication equipment; key financial terminal systems; safety control equipment; etc.Unless expressly designated as a high reliability product or a product for harsh environments in a Renesas Electronics data sheet or other Renesas Electronics document, Renesas Electronics products are not intended or authorized for use in products or systems that may pose a direct threat to human life or bodily injury (artificial life support devices or systems; surgical implantations; etc.), or may cause serious property damage (space system; undersea repeaters; nuclear power control systems; aircraft control systems; key plant systems; military equipment; etc.). Renesas Electronics disclaims any and all liability for any damages or losses incurred by you or any third parties arising from the use of any Renesas Electronics product that is inconsistent with any Renesas Electronics data sheet, user's manual or other Renesas Electronics document.
7. No semiconductor product is absolutely secure. Notwithstanding any security measures or features that may be implemented in Renesas Electronics hardware or software products, Renesas Electronics shall have absolutely no liability arising out of any vulnerability or security breach, including but not limited to any unauthorized access to or use of a Renesas Electronics product or a system that uses a Renesas Electronics product. RENESAS ELECTRONICS DOES NOT WARRANT OR GUARANTEE THAT RENESAS ELECTRONICS PRODUCTS, OR ANY SYSTEMS CREATED USING RENESAS ELECTRONICS PRODUCTS WILL BE INVULNERABLE OR FREE FROM CORRUPTION, ATTACK, VIRUSES, INTERFERENCE, HACKING, DATA LOSS OR THEFT, OR OTHER SECURITY INTRUSION ("Vulnerability Issues"). RENESAS ELECTRONICS DISCLAIMS ANY AND ALL RESPONSIBILITY OR LIABILITY ARISING FROM OR RELATED TO ANY VULNERABILITY ISSUES. FURTHERMORE, TO THE EXTENT PERMITTED BY APPLICABLE LAW, RENESAS ELECTRONICS DISCLAIMS ANY AND ALL WARRANTIES, EXPRESS OR IMPLIED, WITH RESPECT TO THIS DOCUMENT AND ANY RELATED OR ACCOMPANYING SOFTWARE OR HARDWARE, INCLUDING BUT NOT LIMITED TO THE IMPLIED WARRANTIES OF MERCHANTABILITY, OR FITNESS FOR A PARTICULAR PURPOSE.
8. When using Renesas Electronics products, refer to the latest product information (data sheets, user's manuals, application notes, "General Notes for Handling and Using Semiconductor Devices" in the reliability handbook, etc.), and ensure that usage conditions are within the ranges specified by Renesas Electronics with respect to maximum ratings, operating power supply voltage range, heat dissipation characteristics, installation, etc. Renesas Electronics disclaims any and all liability for any malfunctions, failure or accident arising out of the use of Renesas Electronics products outside of such specified ranges.
9. Although Renesas Electronics endeavors to improve the quality and reliability of Renesas Electronics products, semiconductor products have specific characteristics, such as the occurrence of failure at a certain rate and malfunctions under certain use conditions. Unless designated as a high reliability product or a product for harsh environments in a Renesas Electronics data sheet or other Renesas Electronics document, Renesas Electronics products are not subject to radiation resistance design. You are responsible for implementing safety measures to guard against the possibility of bodily injury, injury or damage caused by fire, and/or danger to the public in the event of a failure or malfunction of Renesas Electronics products, such as safety design for hardware and software, including but not limited to redundancy, fire control and malfunction prevention, appropriate treatment for aging degradation or any other appropriate measures. Because the evaluation of microcomputer software alone is very difficult and impractical, you are responsible for evaluating the safety of the final products or systems manufactured by you.
10. Please contact a Renesas Electronics sales office for details as to environmental matters such as the environmental compatibility of each Renesas Electronics product. You are responsible for carefully and sufficiently investigating applicable laws and regulations that regulate the inclusion or use of controlled substances, including without limitation, the EU RoHS Directive, and using Renesas Electronics products in compliance with all these applicable laws and regulations. Renesas Electronics disclaims any and all liability for damages or losses occurring as a result of your noncompliance with applicable laws and regulations.
11. Renesas Electronics products and technologies shall not be used for or incorporated into any products or systems whose manufacture, use, or sale is prohibited under any applicable domestic or foreign laws or regulations. You shall comply with any applicable export control laws and regulations promulgated and administered by the governments of any countries asserting jurisdiction over the parties or transactions.
12. It is the responsibility of the buyer or distributor of Renesas Electronics products, or any other party who distributes, disposes of, or otherwise sells or transfers the product to a third party, to notify such third party in advance of the contents and conditions set forth in this document.
13. This document shall not be reprinted, reproduced or duplicated in any form, in whole or in part, without prior written consent of Renesas Electronics.
14. Please contact a Renesas Electronics sales office if you have any questions regarding the information contained in this document or Renesas Electronics products.

(Note1) "Renesas Electronics" as used in this document means Renesas Electronics Corporation and also includes its directly or indirectly controlled subsidiaries.

(Note2) "Renesas Electronics product(s)" means any product developed or manufactured by or for Renesas Electronics.

(Rev.5.0-1 October 2020)

Corporate Headquarters

TOYOSU FORESIA, 3-2-24 Toyosu,
Koto-ku, Tokyo 135-0061, Japan

www.renesas.com

Trademarks

Renesas and the Renesas logo are trademarks of Renesas Electronics Corporation. All trademarks and registered trademarks are the property of their respective owners.

Contact information

For further information on a product, technology, the most up-to-date version of a document, or your nearest sales office, please visit:

www.renesas.com/contact/.