

RX72M Group

R01AN4740EJ0101

Rev.1.01

Jan. 31, 2020

Communications Board CANopen (Slave) Startup Manual

Introduction

This is a quick start guide to running CANopen® communications on the RX72M communications board for evaluating industrial networks.

Target Device

- RX72M Group

Sample Program

This sample program uses the evaluation version of the CANopen stack produced by one of our partners, M2M craft Co., Ltd. The stack's major communications specifications are as follows.

- Communications protocol: Compliant with CANopen CiA 301 v4.2
- Supports the conformance test tool v3.0.3.8

For purchase of the official version of the stack and the specifications of the sample program, contact M2M craft Co., Ltd.

M2M craft Co., Ltd. Web site: <http://m2mcraft.co.jp/>

[Restrictions]

The evaluation version of the CANopen stack consists of library files which were built with the functional limitations as listed below. This version is only made available for purposes of evaluation.

- The numbers of communications services and types are fixed.
- The number of objects that can be registered in the object dictionary has a limit of 15.
- The evaluation stack automatically stops running after 60 minutes. Re-starting the program requires resetting the device.

Please note that the evaluation stack cannot be used in commercial products. Purchasing the official version of the CANopen stack is required if it is to be used in a commercial product.

Contents

1. Operating Environment.....	3
2. Setting up and Connecting the Evaluation Board.....	4
2.1 Setting up the Board.....	5
2.2 Selecting the Power Source	5
3. Installing the e ² studio.....	6
3.1 Installing the CC-RX Compiler V3.01.00.....	6
3.2 How to check the registered Compiler	6
4. Connections	8
5. Importing a Sample Project to the e ² studio	9
6. Programming and Debugging	10
7. Appendix	12
7.1 Verifying Operation of the Sample Project	12
7.1.1 Configuration of Connections.....	12
7.1.2 Overview of CANopen Master Operations	14
7.1.3 Verifying the Results of Operations.....	15
7.1.3.1 The RX72M Communications Board as Node ID 32	15
7.1.3.2 The RX72M Communications Board as Node ID 72	15
7.1.4 Changing the Node ID of the RX72M Communications Board	16

1. Operating Environment

The sample program covered in this manual runs in the environment below.

Table 1.1 Operating Environment

Item	Description
Board	RX72M communications board TS-TCS07298 from Tessera Technology
CPU	RX CPU (RXv3)
Operating frequency	CPU clock (CPUCLK): 240 MHz
Operating voltage	3.3 V
Operating modes	Single chip mode
Device requirements	R5F572MNDDBD <ul style="list-style-type: none"> • Code flash memory Capacity: 4 Mbytes ROM cache: 8 Kbytes • Data flash memory Capacity: 32 Kbytes • RAM/extended RAM Capacity: 512 Kbytes / 512 Kbytes
Communications protocol	CANopen
Integrated development environment	e ² studio (V7.5.0 or later) with the CC-RX compiler (V3.01.00)
Emulator (ICE)	Renesas E2 Lite

2. Setting up and Connecting the Evaluation Board

For detailed information on the board, refer to the *RX72M Group Communications Board Hardware Manual*.

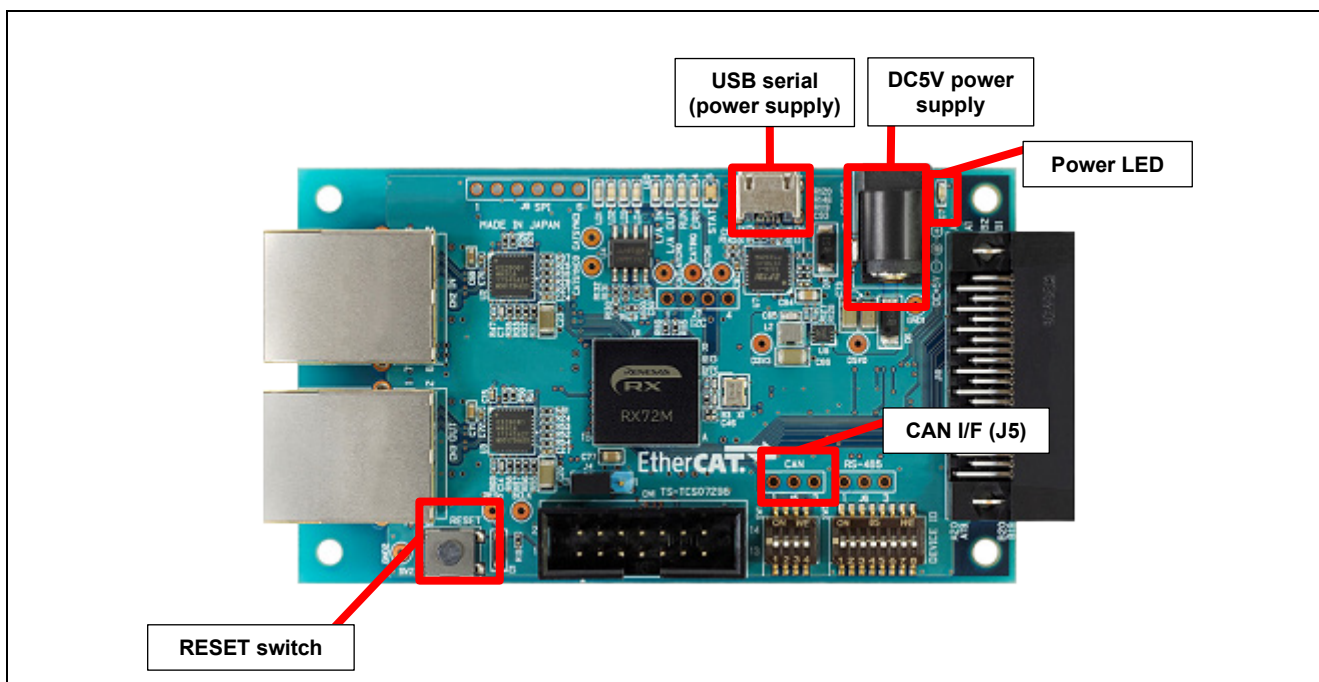

Figure 2.1 Configuration of the RX72M Communications Board

Table 2.1 CAN Interface (J5)

Pin Number	I/O	Signal Name
1	I/O	CANH
2	I/O	CANL
3	—	GND

2.1 Setting up the Board

Before supplying power to the board, set up jumpers and connect the cables. In addition, make settings for the JTAG configuration mode. This mode is normally used with a short circuit between jumper pins 2 and 3.

For the detailed locations of the related parts, refer to the *RX72M Communications Board Hardware Manual*.

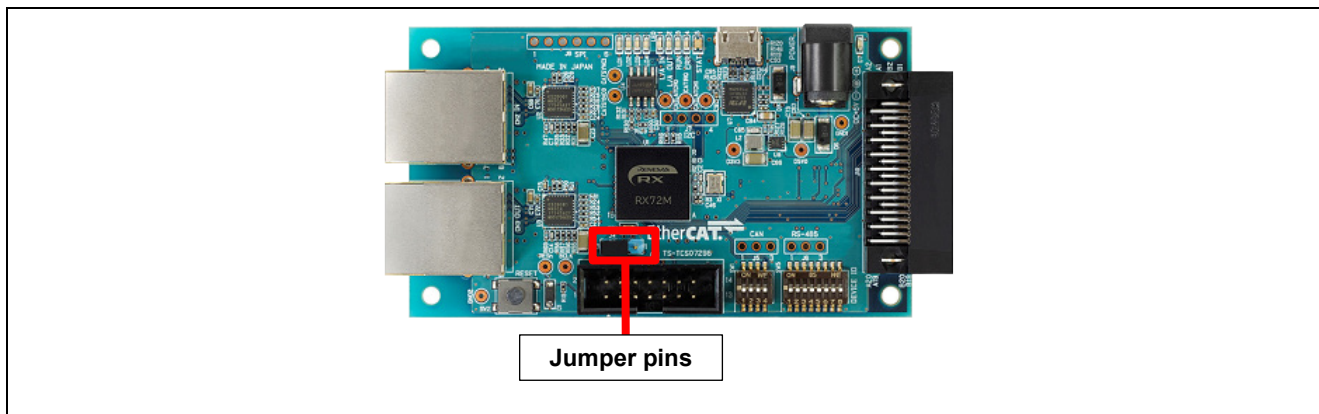

Figure 2.2 Setting up Jumper Pins

2.2 Selecting the Power Source

Power to the RX72M can be supplied from a 5-V DC power source or through the USB port. Use whichever is suitable for the configuration of your operating environment.

3. Installing the e² studio

Download the e² studio for RX72M (V7.5.0 or later) from the Web site below.

https://www.renesas.com/e2studio_download

3.1 Installing the CC-RX Compiler V3.01.00

The compiler selection dialog box appears while installing the e² studio. Click [Renesas CCRX v3.01.00] and select [Next]. CC-RX V3.01.00 Compiler for RX72M will be installed with the e² studio.

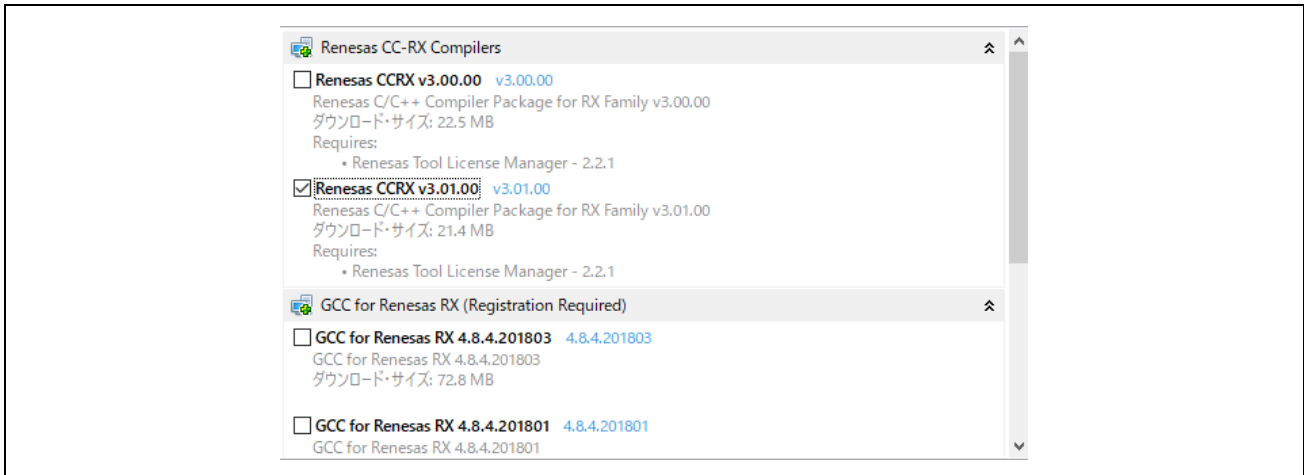

To start the e² studio, execute "e2studio.exe" in the following installation folder.

e2_studio_rx72m\eclipse

3.2 How to check the registered Compiler

- (1) Start the e² studio.
- (2) Select [File] → [New] → [C/C++Project] → [Next].

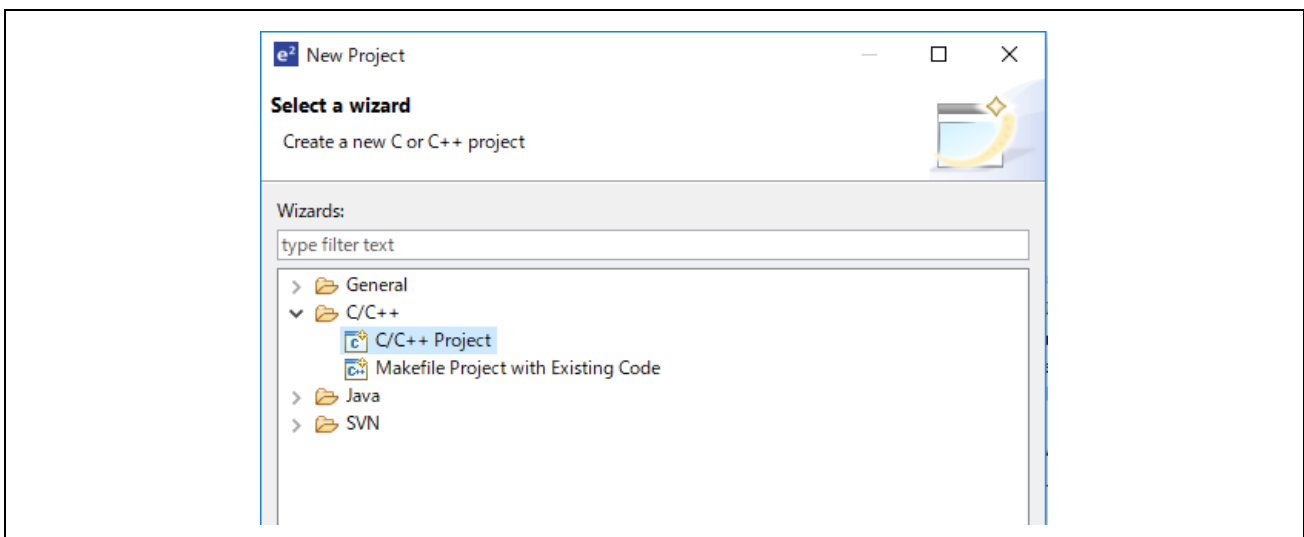

- (3) In the [Templates for New C/C++ Project] dialog box, select [Renesas RX] → [Renesas CC-RX C/C++ Executable Project] → [Next].

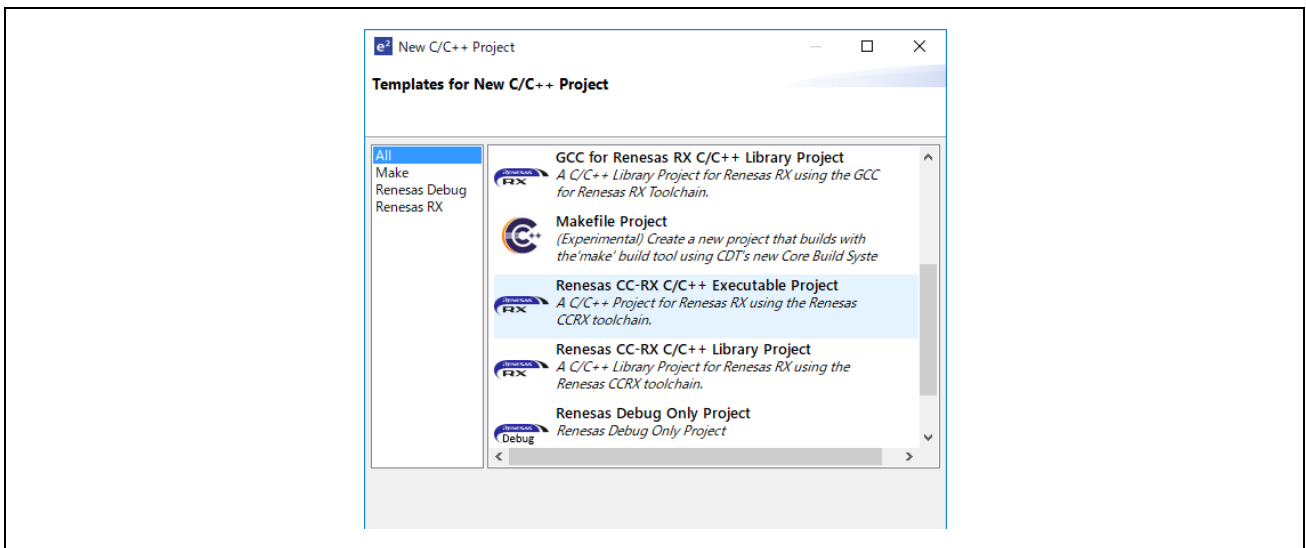

- (4) In the [New Renesas CC-RX C/C++ Executable Project] dialog box, enter a desired project name and select [Next].
- (5) In the [Select toolchain, device & debug settings] dialog box, select [Manage Toolchains...] under [Toolchain Settings].
- (6) In the [Renesas Toolchain Management] dialog box, the registration was successful if "v3.01.00" has been added under "Renesas CCRX".

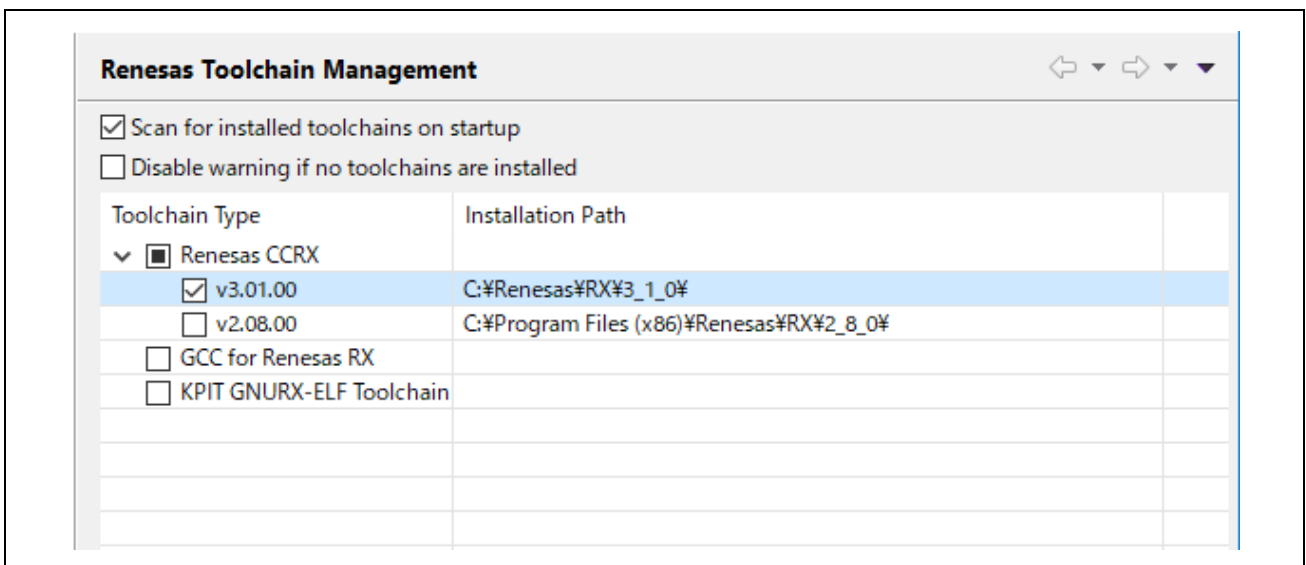

4. Connections

- (1) Connect the CAN interface to the CAN bus.
- (2) Connect the E2 Emulator Lite to the JTAG connector on the communications board with the user interface cable.
- (3) Connect the E2 Emulator Lite to a USB port of the PC you are using. The "ACT" LED on the E2 Emulator Lite starts to blink.
- (4) The "Found new hardware" wizard appears. Follow the procedure described below to install the driver. Installation on a PC running Windows™ 7, 8, or 8.1 requires logging in with a user name that has administrator rights.
 - Windows™ 7/8/8.1: A notice appears on the Windows taskbar when the installation is finished.
 - Windows™ 10: A button for device configuration appears on the Windows taskbar and installation is automatic.
- (5) Supply power to the communications board from a 5-V DC power source or through the USB port.

5. Importing a Sample Project to the e² studio

(1) Select [File] → [Import].

(2) In the [Select] dialog box, select [General] → [Existing Projects into Workspace] and select [Next].

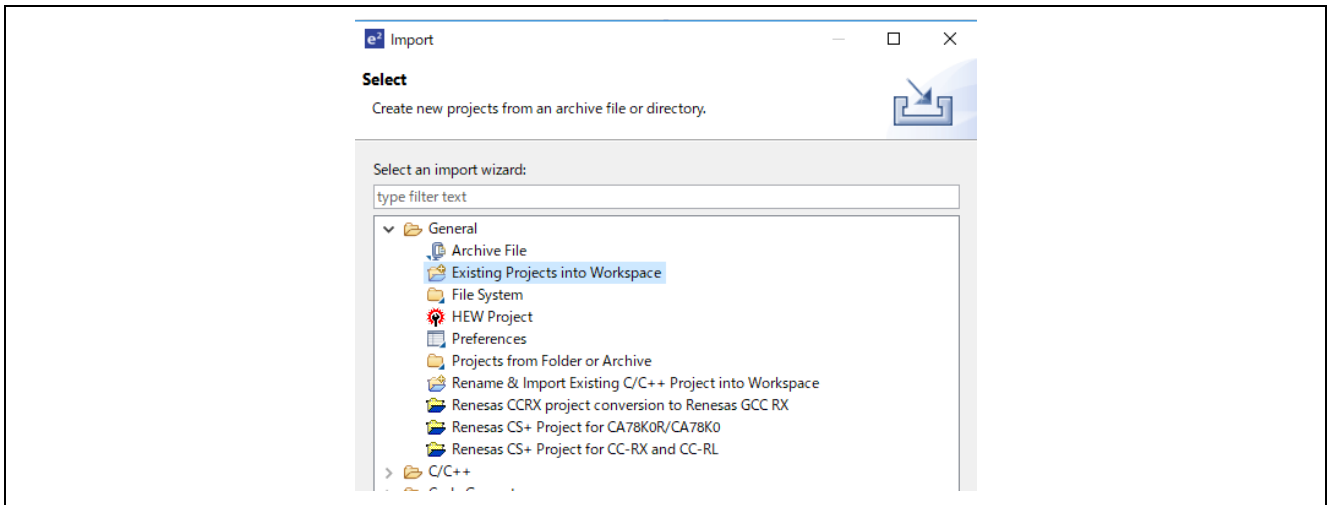

(3) In the [Import Projects] dialog box, check the "Select archive file:" button, then select [Browse...].

(4) Select "RX72M_CoSlave.zip" as a sample project file for the communications board, and select [Open].

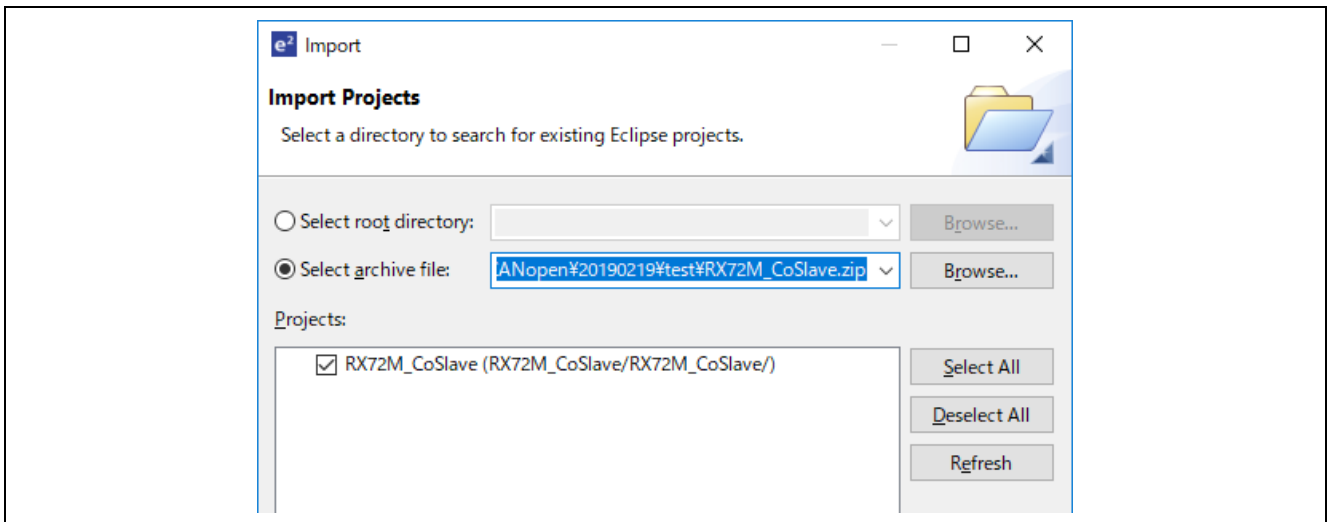

Check "RX72M_CoSlave(RX72M_CoSlave/RX72M_CoSlave/)" under the "Projects" label and select [Next]. The project will be imported into the workspace.

6. Programming and Debugging

- (1) Select the "RX72M_CoSlave " project in the Project Explorer view. Select the arrow next to the build button (hammer icon) and select [HardwareDebug] from the drop-down menu.

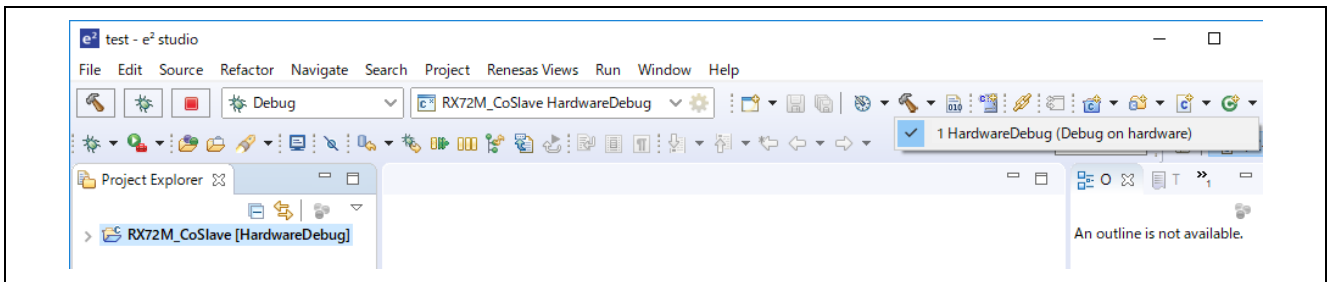

- (2) e² studio will build the project. After the build is completed, select the arrow next to the debug button (bug icon). You can start debugging by selecting [Debug Configurations...].

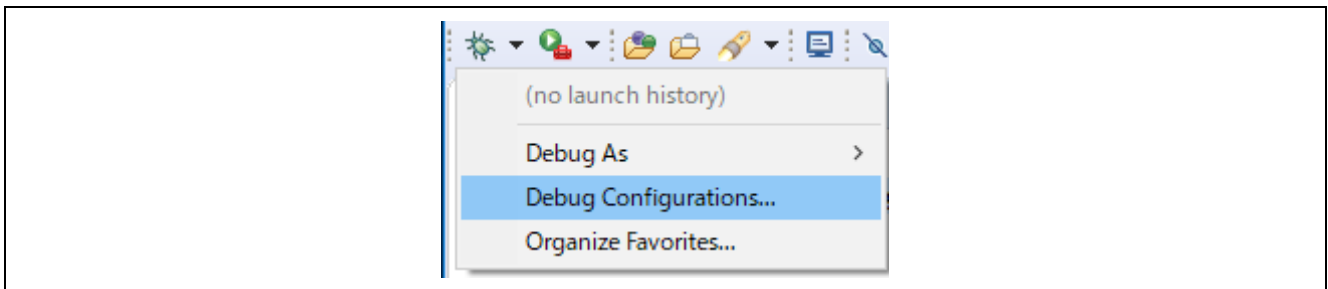

- (3) Select the file "RX72M_CoSlave HardwareDebug" and download the program to the target device. Click on the [Debug] button to start debugging.

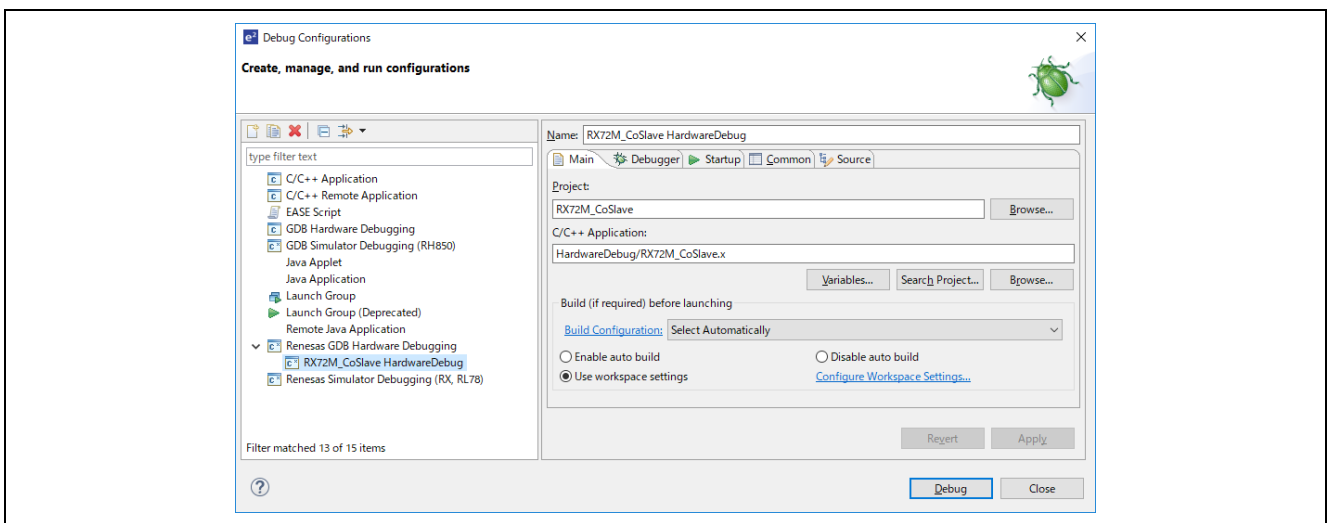

- (4) If a firewall warning is displayed for "e2-server-gdb.exe", check the checkbox for [Private networks, such as my home or work network] and select [Allow access].
- (5) The User Account Control (UAC) dialog box may appear. Enter the administrator's password and select [Yes].
- (6) If the Confirm Perspective Switch dialog box appears prompting you to switch the perspective, check the checkbox for [Remember my decision] and select [Yes].
- (7) The green "ACT" LED on the E2 Lite debugger will be continuously lit.
- (8) After downloading the code, select the [Resume] button to run the code. The code will break at the address where the main function starts. Select the [Resume] button again to continue to run the code.

7. Appendix

7.1 Verifying Operation of the Sample Project

Operation of the sample project can be verified as follows.

7.1.1 Configuration of Connections

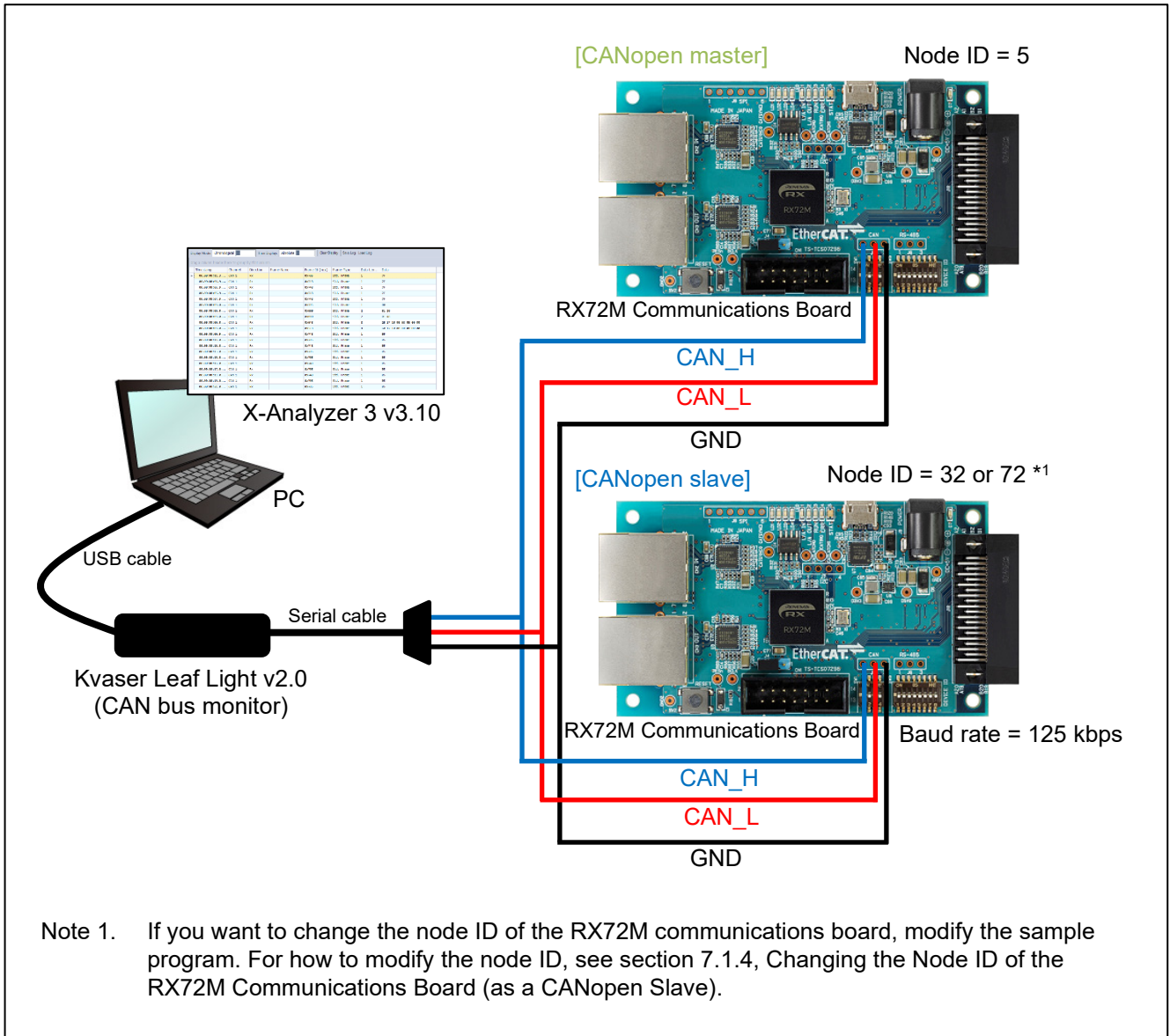

Figure 7.1 Configuration of Connections

Table 7.1 List of Devices

Item	Description
CANopen slave device	RX72M communications board (with this sample program already written to it) TS-TCS02796 (Tessera Technology)
CANopen master device* ¹	RX72M communications board TS-TCS02796 (Tessera Technology)
CAN bus monitor	Kvaser Leaf Light v2.0 (Kvaser)* ²
PC software	X-Analyzer 3 v3.10 (Warwick Control Technologies)* ²

Notes: 1. Download the CANopen master program for CANopen master devices from the Renesas Electronics website.

2. For how to obtain the device and PC software and related support information, contact the respective manufacturers.

7.1.2 Overview of CANopen Master Operations

After the device is reset and started, operations of the CANopen master are as follows.

- It sends an NMT (network management) message "Start" to node ID 32 (= 0x20) or 72 (= 0x48) to request a change of state to "Operational".
- It sends an SDO (service data object) write request to node ID 72 to request a change of the heartbeat time to 3000 ms.

After that, it monitors to check if the required changes have been correctly made.

A flowchart is given below.

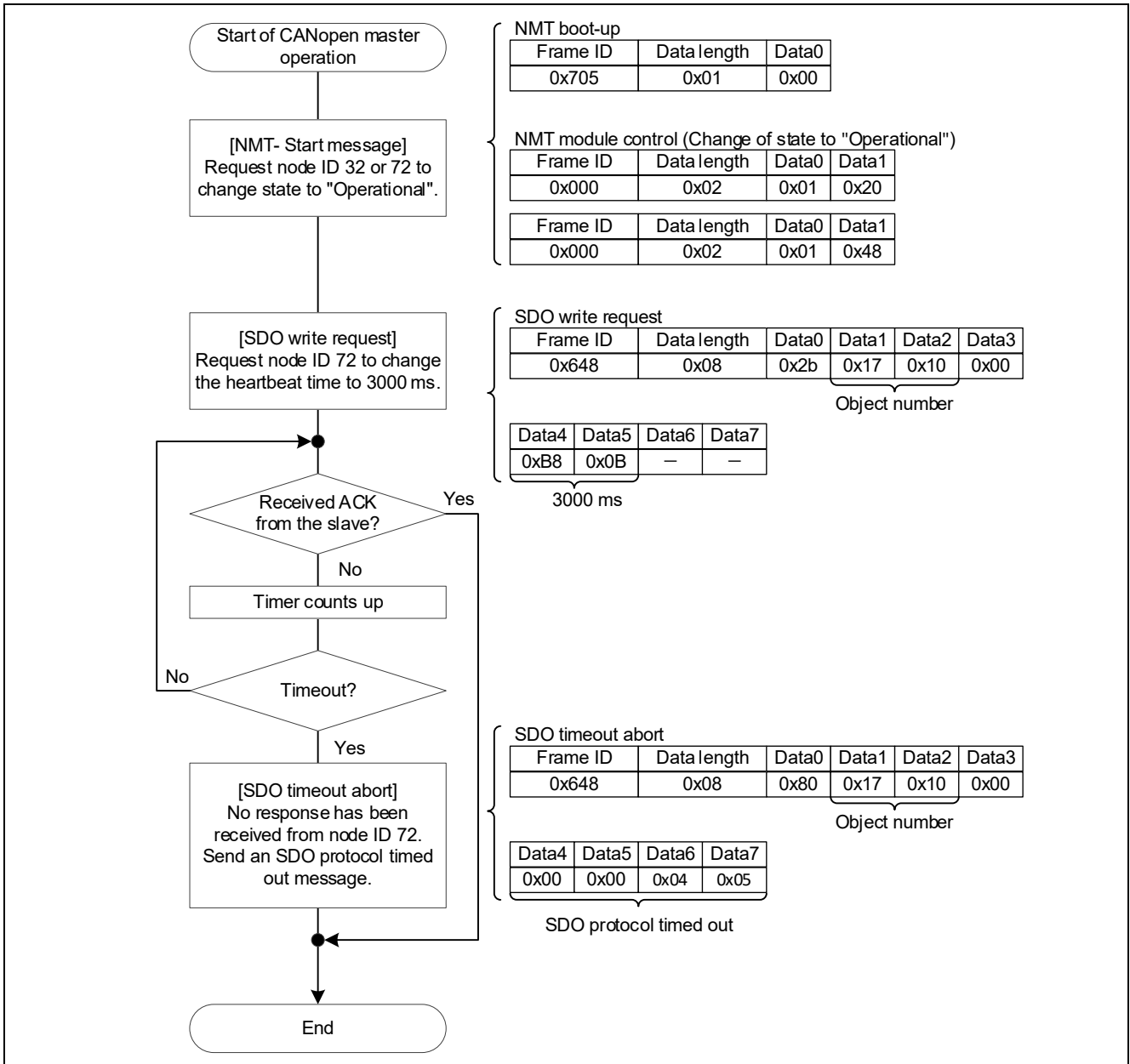

Figure 7.2 Flowchart of CANopen Master Operations

7.1.3 Verifying the Results of Operations

7.1.3.1 The RX72M Communications Board as Node ID 32

The results of communications with the CANopen master device by the RX72M communications board as node ID 32 are shown below.

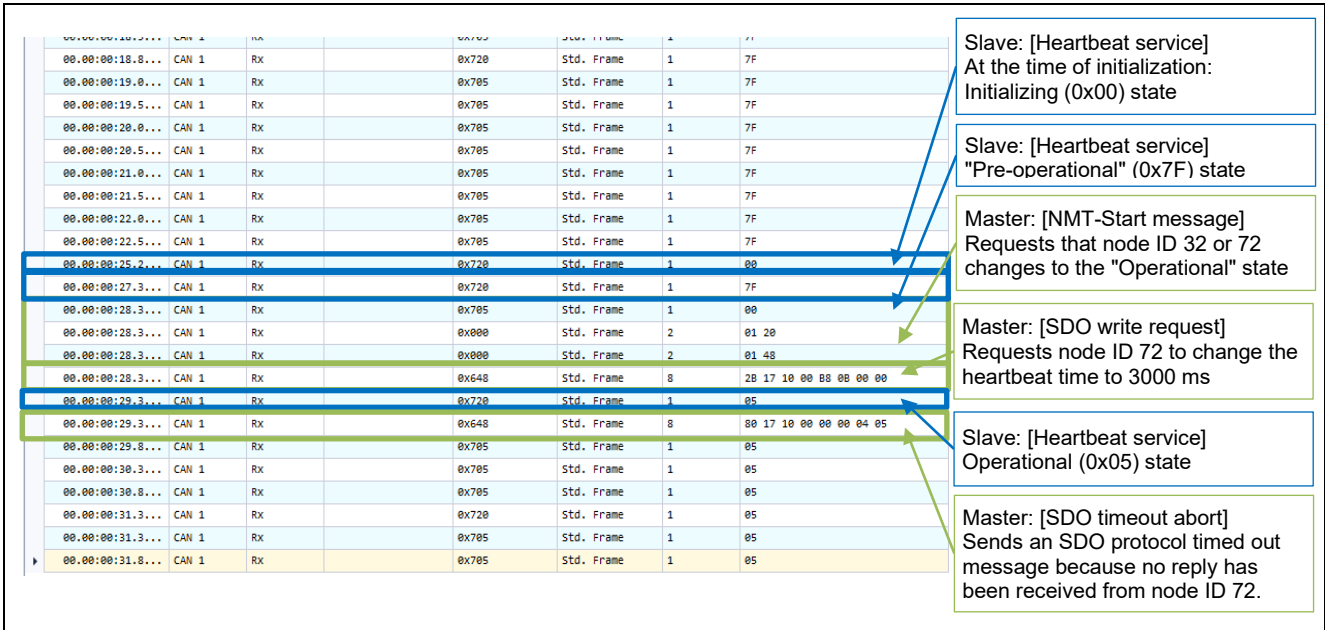

Figure 7.3 Results of Monitoring the X-Analyzer 3

7.1.3.2 The RX72M Communications Board as Node ID 72

The results of communications with the CANopen master device by the RX72M communications board as node ID 72 are shown below.

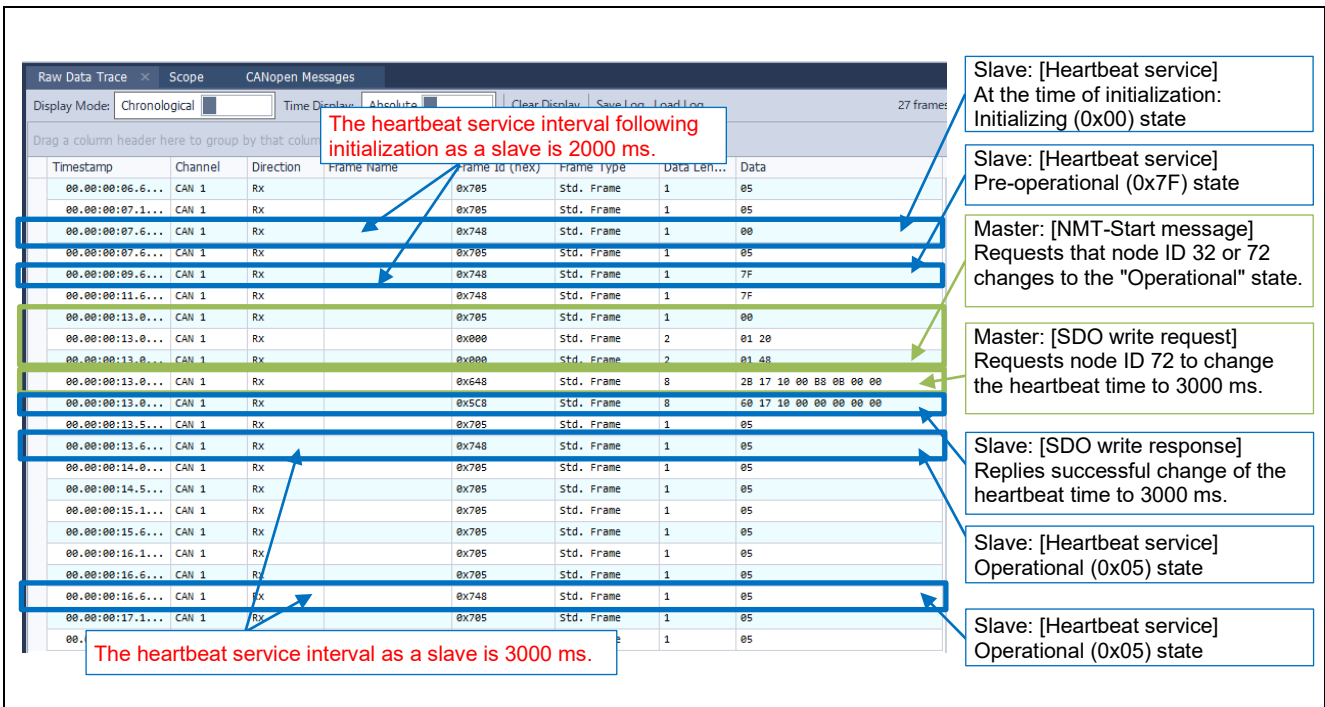

Figure 7.4 Results of Monitoring the X-Analyzer 3

7.1.4 Changing the Node ID of the RX72M Communications Board

To change the node ID assigned to the RX72M communications board, rewrite the value for "#define NODE_ID" in the main.c file of this sample program. After changing the node ID, be sure to rebuild the program before writing it to the board.

```

/* header of standard C - libraries */
#include <string.h>
#include <stdio.h>
#include <stdlib.h>
#define DEF_HW_PART
#include <cal_conf.h> /* !!! first file to include for all CANopen */
#ifdef CONFIG_CPU_FAMILY_LINUX
#include <unistd.h>
#include <time.h>
#endif
#include <co_acces.h>
#include <co_sdo.h>
#include <co_pdo.h>
#include <co_drv.h>
#include <co_lme.h>
#include <co_nmt.h>
#include <co_init.h>
/* examples.h is part of the CANopen driver
 * and contains also the macros
 * PRINTF() for printf()
 * PUTCHAR() for putchar()
 * FFLUSH() for fflush()
 */
#include <examples.h>
#include "objects.h" /* object dictionary */
/* constant definitions
-----
#define NODE_ID 32 /* ID of local node */
*/
/* For the example exists two variants of a macro to print
 * out return values of CANopen system functions.
 * First for small embedded systems, which only puts a '0' (error free)
 * or '1'.
 * Second for systems with a large console capable of printing text.
 */
#ifdef NO_PRINTF_S
#define PRINTRET(s, e) do { \
    if ((e) == 0) { PUTCHAR('0'); } \
    else { PUTCHAR('1'); err = CO_TRUE; } \
} while(0);
#else
#define PRINTRET(s, e) do { \
    PRINTF(s, e); \
    if((e) != 0) err = CO_TRUE; \
} while(0);
#endif

```

To change node ID 32 to node ID 72, change the value to 72.

Website and Support

Renesas Electronics Website

<http://www.renesas.com/>

Inquiries

<http://www.renesas.com/contact/>

All other logos and trademarks are the property of the respective trademark owners.

Revision History

Rev.	Date	Description	
		Page	Summary
1.00	Aug. 2, 2019	-	First edition issued
1.01	Jan. 31, 2020	-	Changed the name of the development partner

General Precautions in the Handling of Microprocessing Unit and Microcontroller Unit Products

The following usage notes are applicable to all Microprocessing unit and Microcontroller unit products from Renesas. For detailed usage notes on the products covered by this document, refer to the relevant sections of the document as well as any technical updates that have been issued for the products.

1. Precaution against Electrostatic Discharge (ESD)

A strong electrical field, when exposed to a CMOS device, can cause destruction of the gate oxide and ultimately degrade the device operation. Steps must be taken to stop the generation of static electricity as much as possible, and quickly dissipate it when it occurs. Environmental control must be adequate. When it is dry, a humidifier should be used. This is recommended to avoid using insulators that can easily build up static electricity.

Semiconductor devices must be stored and transported in an anti-static container, static shielding bag or conductive material. All test and measurement tools including work benches and floors must be grounded. The operator must also be grounded using a wrist strap. Semiconductor devices must not be touched with bare hands. Similar precautions must be taken for printed circuit boards with mounted semiconductor devices.

2. Processing at power-on

The state of the product is undefined at the time when power is supplied. The states of internal circuits in the LSI are indeterminate and the states of register settings and pins are undefined at the time when power is supplied. In a finished product where the reset signal is applied to the external reset pin, the states of pins are not guaranteed from the time when power is supplied until the reset process is completed. In a similar way, the states of pins in a product that is reset by an on-chip power-on reset function are not guaranteed from the time when power is supplied until the power reaches the level at which resetting is specified.

3. Input of signal during power-off state

Do not input signals or an I/O pull-up power supply while the device is powered off. The current injection that results from input of such a signal or I/O pull-up power supply may cause malfunction and the abnormal current that passes in the device at this time may cause degradation of internal elements. Follow the guideline for input signal during power-off state as described in your product documentation.

4. Handling of unused pins

Handle unused pins in accordance with the directions given under handling of unused pins in the manual. The input pins of CMOS products are generally in the high-impedance state. In operation with an unused pin in the open-circuit state, extra electromagnetic noise is induced in the vicinity of the LSI, an associated shoot-through current flows internally, and malfunctions occur due to the false recognition of the pin state as an input signal become possible.

5. Clock signals

After applying a reset, only release the reset line after the operating clock signal becomes stable. When switching the clock signal during program execution, wait until the target clock signal is stabilized. When the clock signal is generated with an external resonator or from an external oscillator during a reset, ensure that the reset line is only released after full stabilization of the clock signal. Additionally, when switching to a clock signal produced with an external resonator or by an external oscillator while program execution is in progress, wait until the target clock signal is stable.

6. Voltage application waveform at input pin

Waveform distortion due to input noise or a reflected wave may cause malfunction. If the input of the CMOS device stays in the area between V_{IL} (Max.) and V_{IH} (Min.) due to noise, for example, the device may malfunction. Take care to prevent chattering noise from entering the device when the input level is fixed, and also in the transition period when the input level passes through the area between V_{IL} (Max.) and V_{IH} (Min.).

7. Prohibition of access to reserved addresses

Access to reserved addresses is prohibited. The reserved addresses are provided for possible future expansion of functions. Do not access these addresses as the correct operation of the LSI is not guaranteed.

8. Differences between products

Before changing from one product to another, for example to a product with a different part number, confirm that the change will not lead to problems. The characteristics of a microprocessing unit or microcontroller unit products in the same group but having a different part number might differ in terms of internal memory capacity, layout pattern, and other factors, which can affect the ranges of electrical characteristics, such as characteristic values, operating margins, immunity to noise, and amount of radiated noise. When changing to a product with a different part number, implement a system-evaluation test for the given product.

- CANopen[®] and CiA[®] are registered trademarks of CAN in Automation.
- Additionally, all product names and service names in this document are the trademarks or registered trademarks which belong to the respective owners.

Notice

1. Descriptions of circuits, software and other related information in this document are provided only to illustrate the operation of semiconductor products and application examples. You are fully responsible for the incorporation or any other use of the circuits, software, and information in the design of your product or system. Renesas Electronics disclaims any and all liability for any losses and damages incurred by you or third parties arising from the use of these circuits, software, or information.
 2. Renesas Electronics hereby expressly disclaims any warranties against and liability for infringement or any other claims involving patents, copyrights, or other intellectual property rights of third parties, by or arising from the use of Renesas Electronics products or technical information described in this document, including but not limited to, the product data, drawings, charts, programs, algorithms, and application examples.
 3. No license, express, implied or otherwise, is granted hereby under any patents, copyrights or other intellectual property rights of Renesas Electronics or others.
 4. You shall not alter, modify, copy, or reverse engineer any Renesas Electronics product, whether in whole or in part. Renesas Electronics disclaims any and all liability for any losses or damages incurred by you or third parties arising from such alteration, modification, copying or reverse engineering.
 5. Renesas Electronics products are classified according to the following two quality grades: "Standard" and "High Quality". The intended applications for each Renesas Electronics product depends on the product's quality grade, as indicated below.
 - "Standard": Computers; office equipment; communications equipment; test and measurement equipment; audio and visual equipment; home electronic appliances; machine tools; personal electronic equipment; industrial robots; etc.
 - "High Quality": Transportation equipment (automobiles, trains, ships, etc.); traffic control (traffic lights); large-scale communication equipment; key financial terminal systems; safety control equipment; etc.
- Unless expressly designated as a high reliability product or a product for harsh environments in a Renesas Electronics data sheet or other Renesas Electronics document, Renesas Electronics products are not intended or authorized for use in products or systems that may pose a direct threat to human life or bodily injury (artificial life support devices or systems; surgical implantations; etc.), or may cause serious property damage (space system; undersea repeaters; nuclear power control systems; aircraft control systems; key plant systems; military equipment; etc.). Renesas Electronics disclaims any and all liability for any damages or losses incurred by you or any third parties arising from the use of any Renesas Electronics product that is inconsistent with any Renesas Electronics data sheet, user's manual or other Renesas Electronics document.
6. When using Renesas Electronics products, refer to the latest product information (data sheets, user's manuals, application notes, "General Notes for Handling and Using Semiconductor Devices" in the reliability handbook, etc.), and ensure that usage conditions are within the ranges specified by Renesas Electronics with respect to maximum ratings, operating power supply voltage range, heat dissipation characteristics, installation, etc. Renesas Electronics disclaims any and all liability for any malfunctions, failure or accident arising out of the use of Renesas Electronics products outside of such specified ranges.
 7. Although Renesas Electronics endeavors to improve the quality and reliability of Renesas Electronics products, semiconductor products have specific characteristics, such as the occurrence of failure at a certain rate and malfunctions under certain use conditions. Unless designated as a high reliability product or a product for harsh environments in a Renesas Electronics data sheet or other Renesas Electronics document, Renesas Electronics products are not subject to radiation resistance design. You are responsible for implementing safety measures to guard against the possibility of bodily injury, injury or damage caused by fire, and/or danger to the public in the event of a failure or malfunction of Renesas Electronics products, such as safety design for hardware and software, including but not limited to redundancy, fire control and malfunction prevention, appropriate treatment for aging degradation or any other appropriate measures. Because the evaluation of microcomputer software alone is very difficult and impractical, you are responsible for evaluating the safety of the final products or systems manufactured by you.
 8. Please contact a Renesas Electronics sales office for details as to environmental matters such as the environmental compatibility of each Renesas Electronics product. You are responsible for carefully and sufficiently investigating applicable laws and regulations that regulate the inclusion or use of controlled substances, including without limitation, the EU RoHS Directive, and using Renesas Electronics products in compliance with all these applicable laws and regulations. Renesas Electronics disclaims any and all liability for damages or losses occurring as a result of your noncompliance with applicable laws and regulations.
 9. Renesas Electronics products and technologies shall not be used for or incorporated into any products or systems whose manufacture, use, or sale is prohibited under any applicable domestic or foreign laws or regulations. You shall comply with any applicable export control laws and regulations promulgated and administered by the governments of any countries asserting jurisdiction over the parties or transactions.
 10. It is the responsibility of the buyer or distributor of Renesas Electronics products, or any other party who distributes, disposes of, or otherwise sells or transfers the product to a third party, to notify such third party in advance of the contents and conditions set forth in this document.
 11. This document shall not be reprinted, reproduced or duplicated in any form, in whole or in part, without prior written consent of Renesas Electronics.
 12. Please contact a Renesas Electronics sales office if you have any questions regarding the information contained in this document or Renesas Electronics products.

(Note1) "Renesas Electronics" as used in this document means Renesas Electronics Corporation and also includes its directly or indirectly controlled subsidiaries.

(Note2) "Renesas Electronics product(s)" means any product developed or manufactured by or for Renesas Electronics.

(Rev.4.0-1 November 2017)

Corporate Headquarters

TOYOSU FORESIA, 3-2-24 Toyosu,
Koto-ku, Tokyo 135-0061, Japan
www.renesas.com

Trademarks

Renesas and the Renesas logo are trademarks of Renesas Electronics Corporation. All trademarks and registered trademarks are the property of their respective owners.

Contact information

For further information on a product, technology, the most up-to-date version of a document, or your nearest sales office, please visit:
www.renesas.com/contact/