

致尊敬的顾客

关于产品目录等资料中的旧公司名称

NEC电子公司与株式会社瑞萨科技于2010年4月1日进行业务整合（合并），整合后的新公司暨“瑞萨电子公司”继承两家公司的所有业务。因此，本资料中虽还保留有旧公司名称等标识，但是并不妨碍本资料的有效性，敬请谅解。

瑞萨电子公司网址：<http://www.renesas.com>

2010年4月1日
瑞萨电子公司

【发行】瑞萨电子公司（<http://www.renesas.com>）

【业务咨询】<http://www.renesas.com/inquiry>

Notice

1. All information included in this document is current as of the date this document is issued. Such information, however, is subject to change without any prior notice. Before purchasing or using any Renesas Electronics products listed herein, please confirm the latest product information with a Renesas Electronics sales office. Also, please pay regular and careful attention to additional and different information to be disclosed by Renesas Electronics such as that disclosed through our website.
2. Renesas Electronics does not assume any liability for infringement of patents, copyrights, or other intellectual property rights of third parties by or arising from the use of Renesas Electronics products or technical information described in this document. No license, express, implied or otherwise, is granted hereby under any patents, copyrights or other intellectual property rights of Renesas Electronics or others.
3. You should not alter, modify, copy, or otherwise misappropriate any Renesas Electronics product, whether in whole or in part.
4. Descriptions of circuits, software and other related information in this document are provided only to illustrate the operation of semiconductor products and application examples. You are fully responsible for the incorporation of these circuits, software, and information in the design of your equipment. Renesas Electronics assumes no responsibility for any losses incurred by you or third parties arising from the use of these circuits, software, or information.
5. When exporting the products or technology described in this document, you should comply with the applicable export control laws and regulations and follow the procedures required by such laws and regulations. You should not use Renesas Electronics products or the technology described in this document for any purpose relating to military applications or use by the military, including but not limited to the development of weapons of mass destruction. Renesas Electronics products and technology may not be used for or incorporated into any products or systems whose manufacture, use, or sale is prohibited under any applicable domestic or foreign laws or regulations.
6. Renesas Electronics has used reasonable care in preparing the information included in this document, but Renesas Electronics does not warrant that such information is error free. Renesas Electronics assumes no liability whatsoever for any damages incurred by you resulting from errors in or omissions from the information included herein.
7. Renesas Electronics products are classified according to the following three quality grades: “Standard”, “High Quality”, and “Specific”. The recommended applications for each Renesas Electronics product depends on the product’s quality grade, as indicated below. You must check the quality grade of each Renesas Electronics product before using it in a particular application. You may not use any Renesas Electronics product for any application categorized as “Specific” without the prior written consent of Renesas Electronics. Further, you may not use any Renesas Electronics product for any application for which it is not intended without the prior written consent of Renesas Electronics. Renesas Electronics shall not be in any way liable for any damages or losses incurred by you or third parties arising from the use of any Renesas Electronics product for an application categorized as “Specific” or for which the product is not intended where you have failed to obtain the prior written consent of Renesas Electronics. The quality grade of each Renesas Electronics product is “Standard” unless otherwise expressly specified in a Renesas Electronics data sheets or data books, etc.
 - “Standard”: Computers; office equipment; communications equipment; test and measurement equipment; audio and visual equipment; home electronic appliances; machine tools; personal electronic equipment; and industrial robots.
 - “High Quality”: Transportation equipment (automobiles, trains, ships, etc.); traffic control systems; anti-disaster systems; anti-crime systems; safety equipment; and medical equipment not specifically designed for life support.
 - “Specific”: Aircraft; aerospace equipment; submersible repeaters; nuclear reactor control systems; medical equipment or systems for life support (e.g. artificial life support devices or systems), surgical implantations, or healthcare intervention (e.g. excision, etc.), and any other applications or purposes that pose a direct threat to human life.
8. You should use the Renesas Electronics products described in this document within the range specified by Renesas Electronics, especially with respect to the maximum rating, operating supply voltage range, movement power voltage range, heat radiation characteristics, installation and other product characteristics. Renesas Electronics shall have no liability for malfunctions or damages arising out of the use of Renesas Electronics products beyond such specified ranges.
9. Although Renesas Electronics endeavors to improve the quality and reliability of its products, semiconductor products have specific characteristics such as the occurrence of failure at a certain rate and malfunctions under certain use conditions. Further, Renesas Electronics products are not subject to radiation resistance design. Please be sure to implement safety measures to guard them against the possibility of physical injury, and injury or damage caused by fire in the event of the failure of a Renesas Electronics product, such as safety design for hardware and software including but not limited to redundancy, fire control and malfunction prevention, appropriate treatment for aging degradation or any other appropriate measures. Because the evaluation of microcomputer software alone is very difficult, please evaluate the safety of the final products or system manufactured by you.
10. Please contact a Renesas Electronics sales office for details as to environmental matters such as the environmental compatibility of each Renesas Electronics product. Please use Renesas Electronics products in compliance with all applicable laws and regulations that regulate the inclusion or use of controlled substances, including without limitation, the EU RoHS Directive. Renesas Electronics assumes no liability for damages or losses occurring as a result of your noncompliance with applicable laws and regulations.
11. This document may not be reproduced or duplicated, in any form, in whole or in part, without prior written consent of Renesas Electronics.
12. Please contact a Renesas Electronics sales office if you have any questions regarding the information contained in this document or Renesas Electronics products, or if you have any other inquiries.

(Note 1) “Renesas Electronics” as used in this document means Renesas Electronics Corporation and also includes its majority-owned subsidiaries.

(Note 2) “Renesas Electronics product(s)” means any product developed or manufactured by or for Renesas Electronics.

关于利用本资料时的注意事项

1. 本资料是为了让用户根据用途选择合适的本公司产品的参考资料, 对于本资料中所记载的技术信息, 并非意味着对本公司或者第三者的知识产权及其他权利做出保证或对实施权力进行的承诺。
2. 对于因使用本资料所记载的产品数据、图、表、程序、算法及其他应用电路例而引起的损害或者对第三者的知识产权及其他权利造成侵犯, 本公司不承担任何责任。
3. 不能将本资料所记载的产品和技术用于大规模破坏性武器的开发等目的、军事目的或其他的军需用途方面。另外, 在出口时必须遵守日本的《外汇及外国贸易法》及其他出口的相关法令并履行这些法令中规定的必要手续。
4. 本资料所记载的产品数据、图、表、程序、算法以及其他应用电路例等所有信息均为本资料发行时的内容, 本公司有可能在未做事先通知的情况下, 对本资料所记载的产品或者产品规格进行更改。所以在购买和使用本公司的半导体产品之前, 请先向本公司的营业窗口确认最新的信息并经常留意本公司通过公司主页(<http://www.renesas.com>)等公开的最新信息。
5. 对于本资料中所记载的信息, 制作时我们尽力保证出版时的精确性, 但不承担因本资料的叙述不当而使顾客遭受损失等的任何相关责任。
6. 在使用本资料所记载的产品数据、图、表等所示的技术内容、程序、算法及其他应用电路例时, 不仅要对所使用的技术信息进行单独评价, 还要对整个系统进行充分的评价。请顾客自行负责, 进行是否适用的判断。本公司对于是否适用不负任何责任。
7. 本资料中所记载的产品并非针对万一出现故障或是错误运行就会威胁到人的生命或给人体带来危害的机器、系统(如各种安全装置或者运输交通用的、医疗、燃烧控制、航天器械、核能、海底中继用的机器和系统等)而设计和制造的, 特别是对于品质和可靠性要求极高的机器和系统等(将本公司指定用于汽车方面的产品用于汽车时除外)。如果要用于上述的目的, 请务必事先向本公司的营业窗口咨询。另外, 对于用于上述目的而造成的损失等, 本公司概不负责。
8. 除上述第7项内容外, 不能将本资料中记载的产品用于以下用途。如果用于以下用途而造成的损失, 本公司概不负责。
 - 1) 生命维持装置。
 - 2) 植埋于人体使用的装置。
 - 3) 用于治疗(切除患部、给药等)的装置。
 - 4) 其他直接影响到人的生命的装置。
9. 在使用本资料所记载的产品时, 对于最大额定值、工作电源电压的范围、散热特性、安装条件及其他条件请在本公司规定的保证范围内使用。如果超出了本公司规定的保证范围使用时, 对于由此而造成的故障和出现的事, 本公司将不承担任何责任。
10. 本公司一直致力于提高产品的质量和可靠性, 但一般来说, 半导体产品总会以一定的概率发生故障、或者由于使用条件不同而出现错误运行等。为了避免因本公司的产品发生故障或者错误运行而导致人身事故和火灾或造成社会性的损失, 希望客户能自行负责进行冗余设计、采取延缓对策及进行防止错误运行等的安全设计(包括硬件和软件两方面的设计)以及老化处理等, 这是作为机器和系统的出厂保证。特别是单片机的软件, 由于单独进行验证很困难, 所以要求在顾客制造的最终的机器及系统上进行安全检验工作。
11. 如果把本资料所记载的产品从其载体设备上卸下, 有可能造成婴儿误吞的危险。顾客在将本公司产品安装到顾客的设备上时, 请顾客自行负责将本公司产品设置为不容易剥落的安全设计。如果从顾客的设备上剥落而造成事故时, 本公司将不承担任何责任。
12. 在未得到本公司的事先书面认可时, 不可将本资料的一部分或者全部转载或者复制。
13. 如果需要了解关于本资料的详细内容, 或者有其他关心的问题, 请向本公司的营业窗口咨询。



瑞萨中国销售·技术支持网点:

瑞萨电子(上海)有限公司

上海市浦东新区陆家嘴环路1233号汇亚大厦205室	邮编: 200120	电话: +86 21 5877 1818	传真: +86 21 6887 7858
北京分公司 北京市海淀区科学院南路2号融科资讯中心C座北楼603F室	邮编: 100190	电话: +86 10 8286 1656	传真: +86 10 8286 1657
青岛分公司 青岛市市南区香港中路10号颐和国际大厦A栋23A楼07室	邮编: 266071	电话: +86 532 6677 7600	传真: +86 532 6677 7608
大连办事处 大连市中山区中山路88号天安国际大厦21楼2103室	邮编: 116001	电话: +86 411 3980 5858	传真: +86 411 3980 5877
深圳分公司 深圳市福田区益田路4068号卓越时代广场18楼1807—1809室	邮编: 518048	电话: +86 755 8283 5260	传真: +86 755 2399 5095

Email: contact.china@renesas.com

瑞萨香港有限公司

香港九龙尖沙咀海港城环球金融中心北座7楼	电话: +852 2265 6688	传真: +852 2377 3473
深圳代表处 深圳市福田区益田路4068号卓越时代广场18楼1802—1806室	邮编: 518048	电话: +86 755 8283 5080
厦门代表处 福建省厦门市厦禾路189号银行中心30楼3002室	邮编: 361003	电话: +86 592 3118 686

Email: contact.hongkong@renesas.com

瑞萨中国地区(包括香港)代理及分销商的联系方式请访问: http://cn.renesas.com/china_rep

瑞萨车载导航系统解决方案



瑞萨电子(上海)有限公司
www.cn.renesas.com
瑞萨香港有限公司
www.hk.renesas.com

下一代车载导航设备系统—融合化·立体化—

提供可以实现定期更新的方法「行驶·安全」和「信息·舒适」的融合

车载导航系统

CD-ROM ▶ DVD-ROM ▶ HDD

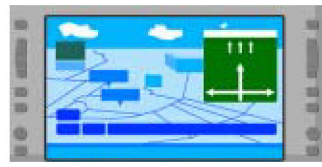

汽车音响

CD ▶ (DVD) ▶ HDD



后排座位·娱乐系统

DVD ▶ TV ▶ Game ▶ Net



LBS: 基于位置的服务 FWA: 固定无线接入

瑞萨的车载导航系统

完整的产品线可以支持从低端车载音响到高端导航系统

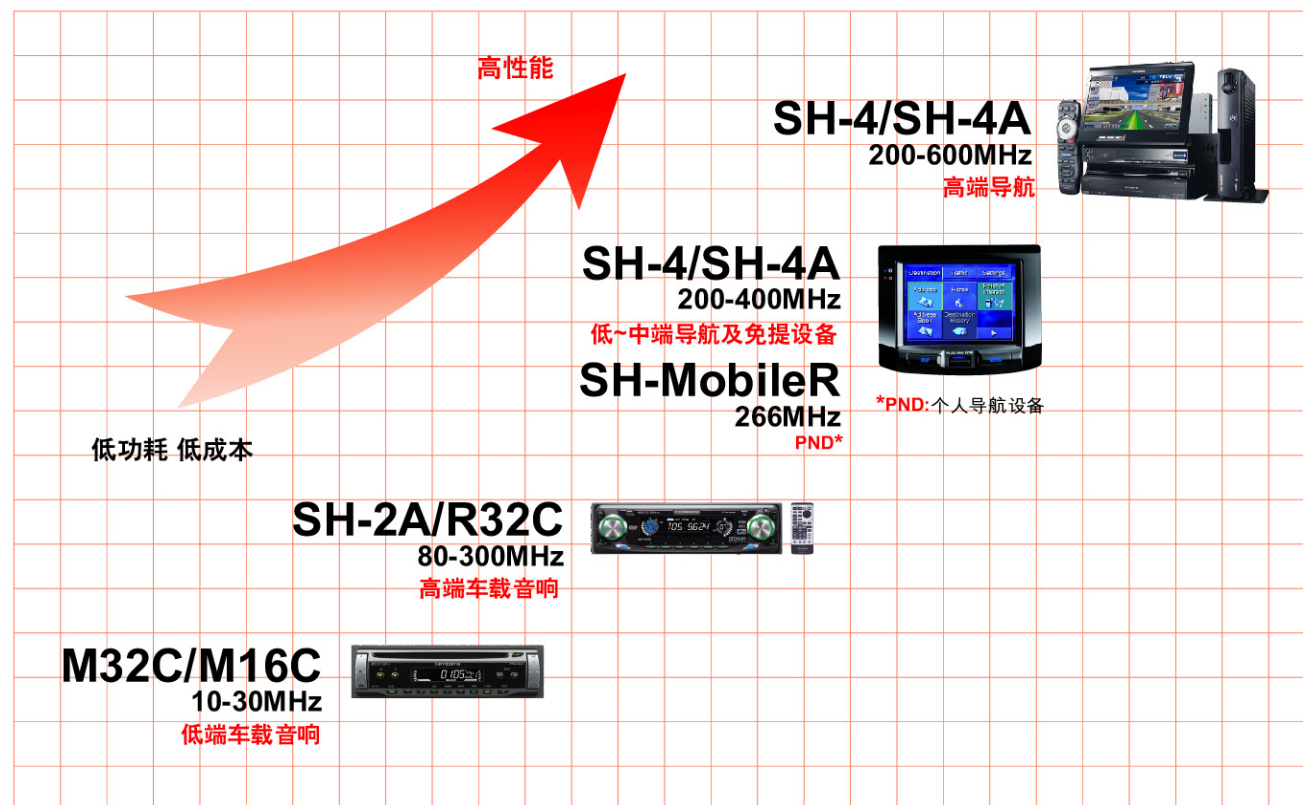

瑞萨导航用SH产品的开发计划

根据导航用户的需求和反馈不断开发有竞争力的产品

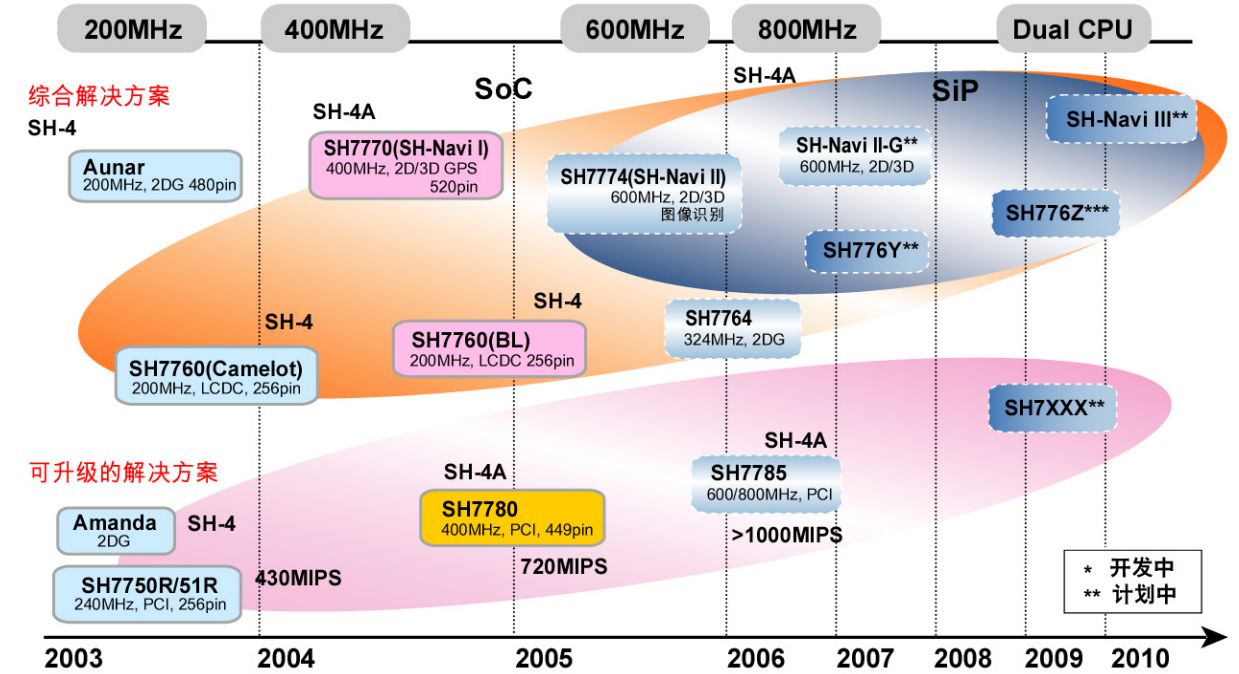

SH7770

一个将3D、GPS和AV外围设备整合于CIS SoC中的事实标准

SH-4A 400MHz	DMAC	HCAN2
FPU	CPG	HSPI
UBC MMU	3D Graphics	HAC
32KB I-cache	2D Graphics	SPDIF
32KB O-cache	Display Unit	SRC
INTC/INTC2	YUV	SSI
WDT	Video In	TMU
EX-Bus Controller	ATAPI	SCIF
DDR-SDRAM Controller	USB(H/F)	RTC
	GPS	PWM
	A/D	IrDA

- CPU** SH4A内核
- 工作频率** 400MHz
- 性能** 整数720MIPS
浮点数2.8GFLOPS
- 工作电压** 1.25V(核)/2.5V(DDR-SDRAM)/3.3V(外围接口)
- 内部存储器** RAM: 16K字节
Cache: 指令=32K字节, 数据=32K字节
- 总线接口** SRAM, Flash, DDR-SDRAM
- 图形/视频** DU 854 × 480(16bit像素), 6层输出
VIN 720 × 288视频输入
2DG 800M像素/秒
3DG 3.1M多边形/秒, YUV彩色空间转换
- GPS** 基带
- 音频接口** HAC, SSI(4通道), SPDIF
- USB** USB主/设备
- CAN2.0** HCAN2
- ATAPI** 主/从支持
- 其他接口** I²C, HSPI(2通道), SCIF(10通道), IrDA, GPIO
- 其他内部模块** RTC, PWM, TMU(32bit, 9通道)
ADC(32bit, 4通道), SRC(采样率转换)
- 工作环境温度** -40~85°C
- 封装** BGA520

采用SH7770构成的导航仪系统框图

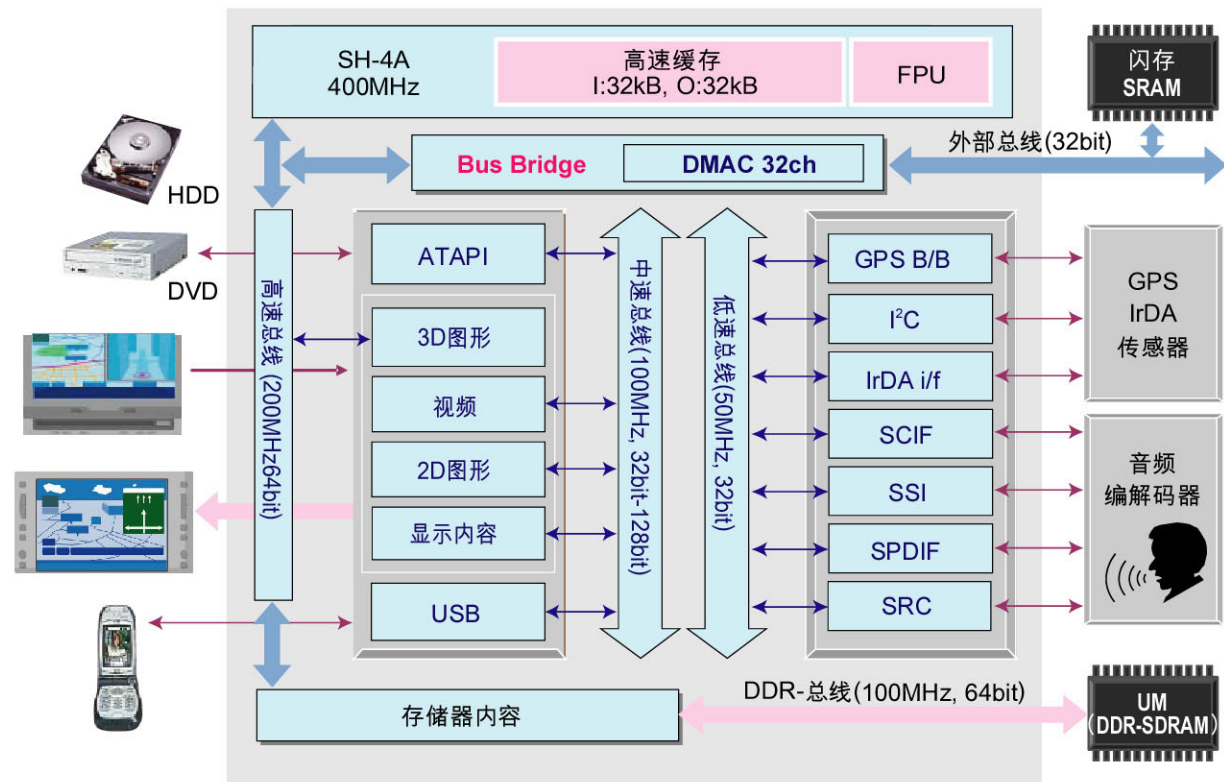

2D图形加速器

• 高性能的粗线命令

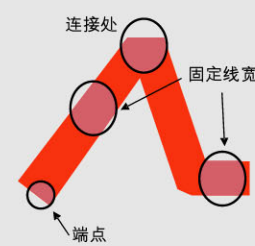

• BitBLT命令

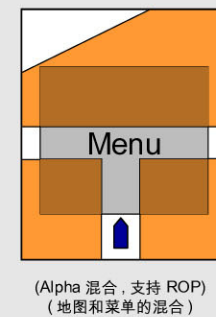

• 抗锯齿(Anti-aliasing)

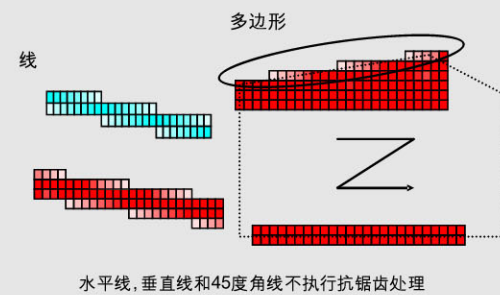

3D图形加速器

• 传统方法

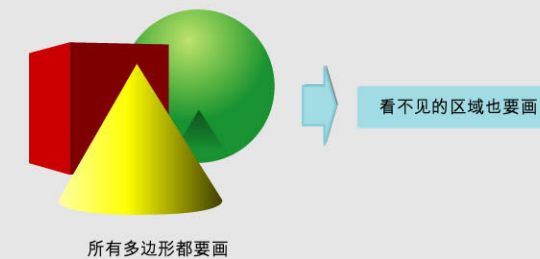

• SH7770

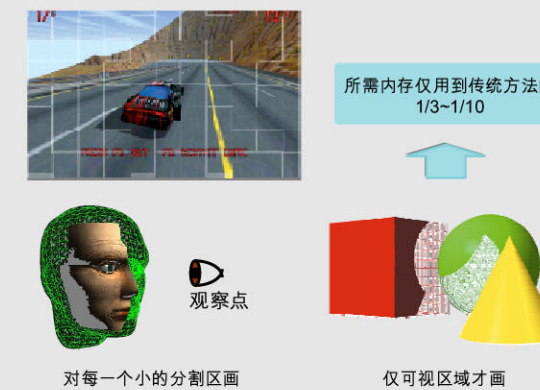

SH7770导航系统参考平台(Lanbic)

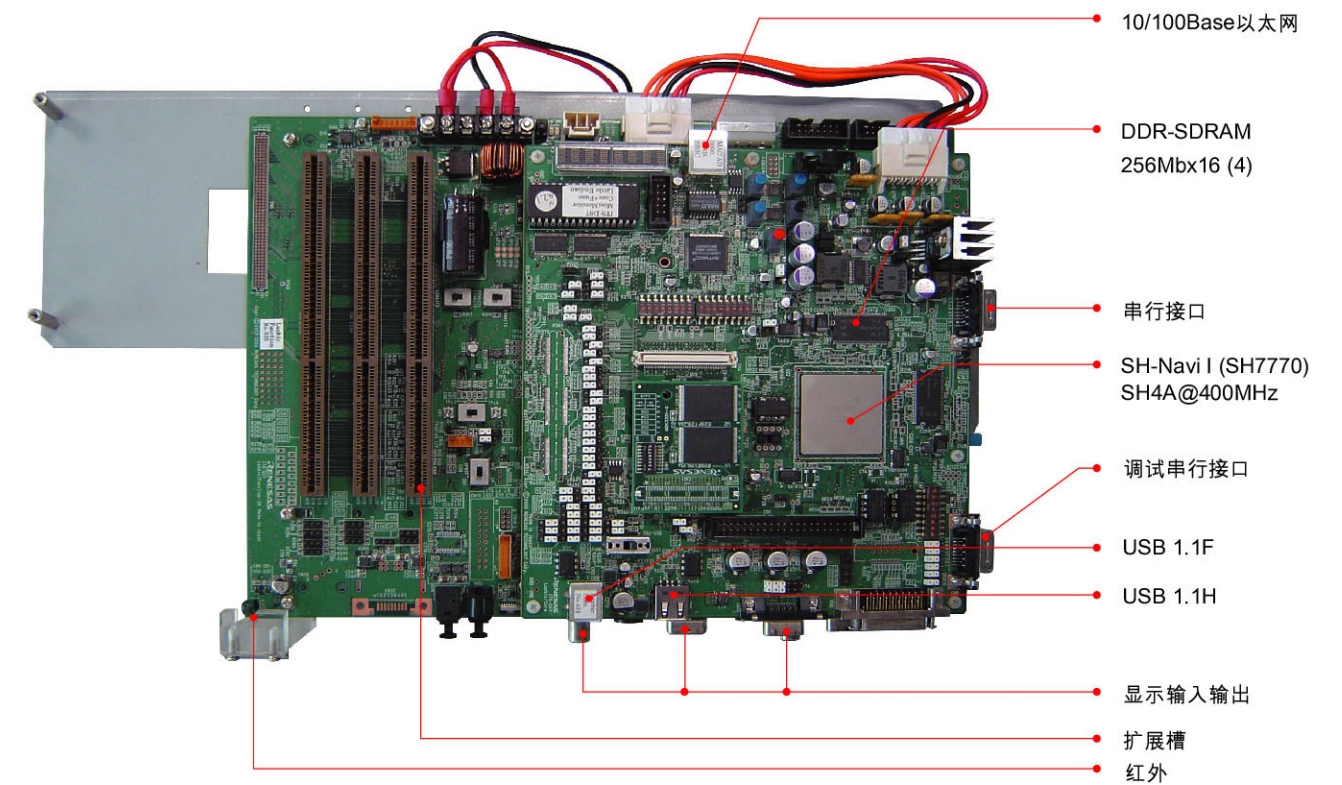

SH7770导航系统参考平台(Lanbic) 介绍

• 操作频率

CPU : 400MHz
 DDR-SDRAM: 100MHz
 (128MB, 4pcs)
 外部总线: 50MHz

• 功能模块

CPU : SH-4A
 Flash : 64MB NOR
 图形: 2D/3D硬件加速
 声音: SSI(3ch), HAC
 存储接口: ATAPI
 串行接口: USB, IrDA, SCIF(9ch)等
 网络: HCAN2, I²C, 以太网

• 操作系统

Windows CE 4.2/5.0/6.0

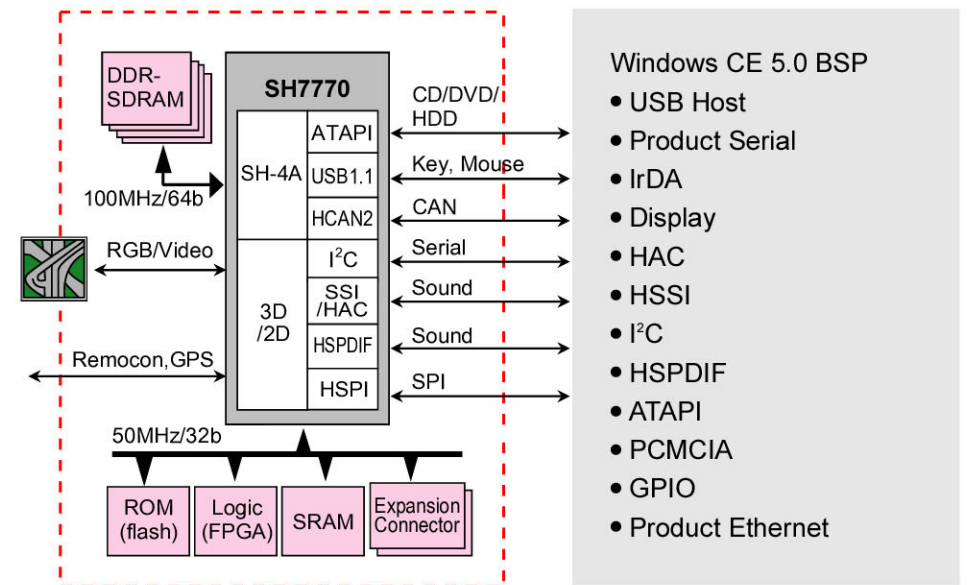

SH7764

具备丰富外围接口功能的中低端导航仪解决方案

SH-4A 324MHz	MMU	I-Cache 32kB	Data Cache 32kB	RAM 16kB
MCU ROM,SRAM,SDRAM	FPU	INTC	DMAC 6ch	SRC 2ch
12C 1ch	GPIO	TMU 23bit 6ch	WDT	H-UDI Flash I/F
SCIF 3ch	SSI 6ch	IDE controller 1ch	USB 2.0 host/function (HS)1ch	
Ether MAC 1ch	MS/SD IO	AES	2D Graphic	VDC2 Digital RGB
				LCDC

- CPU** SH-4A内核
- 工作频率** 324MHz
- 性能** 整数583MIPS
浮点数2.3GFLOPS
- 工作电压** 1.2V(核)/3.3V(外围接口)
- 内部存储器** RAM:16K字节
Cache:指令=32K字节,数据=32K字节
- 总线接口** SRAM, Flash, SDRAM
- 图形/视频** VDC2, 数字RGB接口, 四层输出
LCDC(LCD控制器)
2D图形加速器
- 音频接口** SSI(6通道)
- IDE Controller(1通道)** IDE控制器
- Ether MAC(1通道)** 以太网控制器
- NAND Flash接口** 支持8G bit, SLC NAND
- MS/SDIO** SD卡控制器,支持SDHC, 16G字节
- USB2.0** 支持主/设备功能和HUB
- 其他接口** I²C(1通道), SCIF(3通道), GPIO
- 其他内部模块** TMU(32bit,6通道), WDT(看门狗, 1通道),
DMA控制器(6通道), SRC(采样率转换, 2通道)
INTC(中断控制器), H-UDI(用户调试接口)
- 工作环境温度** -40~85°C
- 封装** BGA404

采用SH7764构成的中低端导航仪系统框图

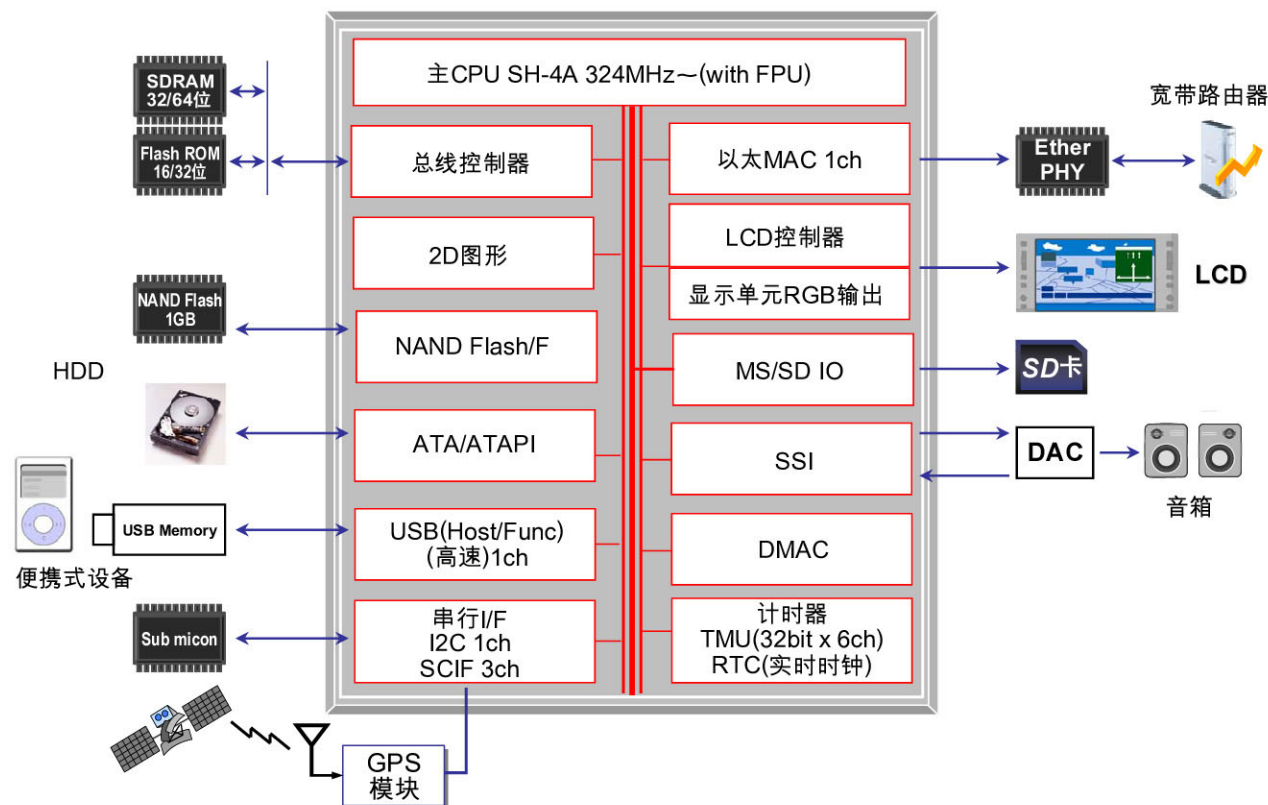

SH7764导航系统参考平台

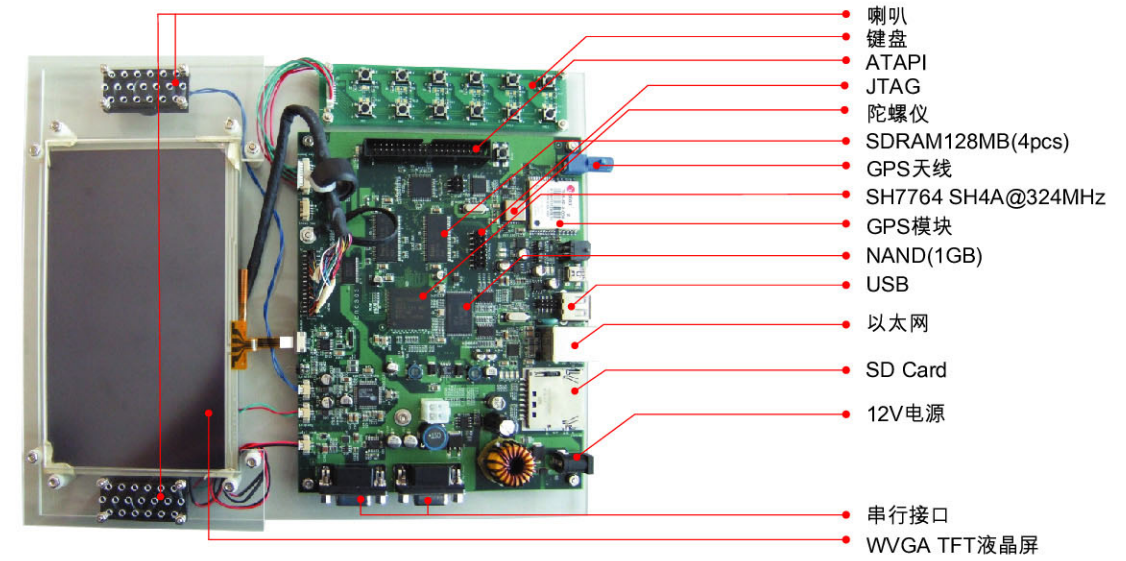

SH7764导航系统参考平台介绍

- 操作频率**
CPU : 324MHz
SDRAM : 108MHz(128MB, 4pcs)
外部总线: 54MHz
- 功能模块**
CPU : SH7764(SH4A)
Flash : 32MB NOR, 1GB NAND
图形显示: WVGA TFT LCD液晶屏
2D硬件加速
声音: SSI, SRC
存储接口: ATAPI, SD卡
串行接口: USB(2个, 采用Hub),
串口(2个)等
输入: 触摸屏, 键盘
网络接口: 以太网, I²C
SubMCU: R8C/27
导航: GPS和陀螺仪
电源: 12V直流输入
JTAG : H-UDI Connector(14-pin)
- 操作系统**
Windows CE 6.0

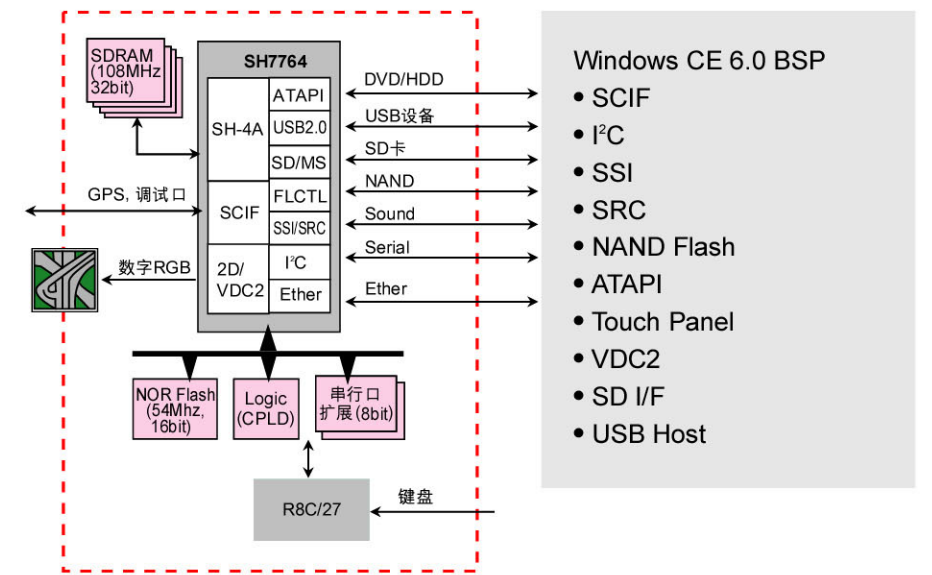

SH7764参考平台开发环境

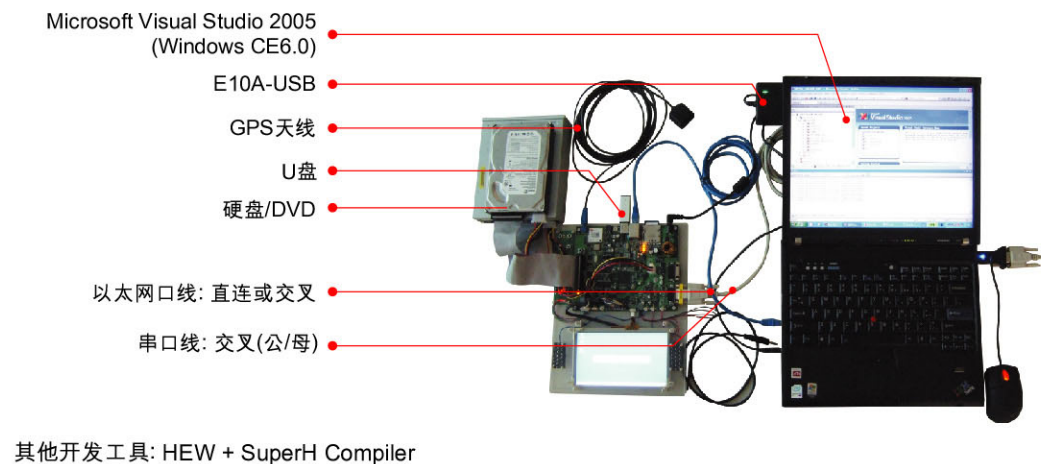

其他开发工具: HEW + SuperH Compiler