

To our customers,

---

## Old Company Name in Catalogs and Other Documents

---

On April 1<sup>st</sup>, 2010, NEC Electronics Corporation merged with Renesas Technology Corporation, and Renesas Electronics Corporation took over all the business of both companies. Therefore, although the old company name remains in this document, it is a valid Renesas Electronics document. We appreciate your understanding.

Renesas Electronics website: <http://www.renesas.com>

April 1<sup>st</sup>, 2010  
Renesas Electronics Corporation

Issued by: Renesas Electronics Corporation (<http://www.renesas.com>)

Send any inquiries to <http://www.renesas.com/inquiry>.

## Notice

1. All information included in this document is current as of the date this document is issued. Such information, however, is subject to change without any prior notice. Before purchasing or using any Renesas Electronics products listed herein, please confirm the latest product information with a Renesas Electronics sales office. Also, please pay regular and careful attention to additional and different information to be disclosed by Renesas Electronics such as that disclosed through our website.
2. Renesas Electronics does not assume any liability for infringement of patents, copyrights, or other intellectual property rights of third parties by or arising from the use of Renesas Electronics products or technical information described in this document. No license, express, implied or otherwise, is granted hereby under any patents, copyrights or other intellectual property rights of Renesas Electronics or others.
3. You should not alter, modify, copy, or otherwise misappropriate any Renesas Electronics product, whether in whole or in part.
4. Descriptions of circuits, software and other related information in this document are provided only to illustrate the operation of semiconductor products and application examples. You are fully responsible for the incorporation of these circuits, software, and information in the design of your equipment. Renesas Electronics assumes no responsibility for any losses incurred by you or third parties arising from the use of these circuits, software, or information.
5. When exporting the products or technology described in this document, you should comply with the applicable export control laws and regulations and follow the procedures required by such laws and regulations. You should not use Renesas Electronics products or the technology described in this document for any purpose relating to military applications or use by the military, including but not limited to the development of weapons of mass destruction. Renesas Electronics products and technology may not be used for or incorporated into any products or systems whose manufacture, use, or sale is prohibited under any applicable domestic or foreign laws or regulations.
6. Renesas Electronics has used reasonable care in preparing the information included in this document, but Renesas Electronics does not warrant that such information is error free. Renesas Electronics assumes no liability whatsoever for any damages incurred by you resulting from errors in or omissions from the information included herein.
7. Renesas Electronics products are classified according to the following three quality grades: “Standard”, “High Quality”, and “Specific”. The recommended applications for each Renesas Electronics product depends on the product’s quality grade, as indicated below. You must check the quality grade of each Renesas Electronics product before using it in a particular application. You may not use any Renesas Electronics product for any application categorized as “Specific” without the prior written consent of Renesas Electronics. Further, you may not use any Renesas Electronics product for any application for which it is not intended without the prior written consent of Renesas Electronics. Renesas Electronics shall not be in any way liable for any damages or losses incurred by you or third parties arising from the use of any Renesas Electronics product for an application categorized as “Specific” or for which the product is not intended where you have failed to obtain the prior written consent of Renesas Electronics. The quality grade of each Renesas Electronics product is “Standard” unless otherwise expressly specified in a Renesas Electronics data sheets or data books, etc.
  - “Standard”: Computers; office equipment; communications equipment; test and measurement equipment; audio and visual equipment; home electronic appliances; machine tools; personal electronic equipment; and industrial robots.
  - “High Quality”: Transportation equipment (automobiles, trains, ships, etc.); traffic control systems; anti-disaster systems; anti-crime systems; safety equipment; and medical equipment not specifically designed for life support.
  - “Specific”: Aircraft; aerospace equipment; submersible repeaters; nuclear reactor control systems; medical equipment or systems for life support (e.g. artificial life support devices or systems), surgical implantations, or healthcare intervention (e.g. excision, etc.), and any other applications or purposes that pose a direct threat to human life.
8. You should use the Renesas Electronics products described in this document within the range specified by Renesas Electronics, especially with respect to the maximum rating, operating supply voltage range, movement power voltage range, heat radiation characteristics, installation and other product characteristics. Renesas Electronics shall have no liability for malfunctions or damages arising out of the use of Renesas Electronics products beyond such specified ranges.
9. Although Renesas Electronics endeavors to improve the quality and reliability of its products, semiconductor products have specific characteristics such as the occurrence of failure at a certain rate and malfunctions under certain use conditions. Further, Renesas Electronics products are not subject to radiation resistance design. Please be sure to implement safety measures to guard them against the possibility of physical injury, and injury or damage caused by fire in the event of the failure of a Renesas Electronics product, such as safety design for hardware and software including but not limited to redundancy, fire control and malfunction prevention, appropriate treatment for aging degradation or any other appropriate measures. Because the evaluation of microcomputer software alone is very difficult, please evaluate the safety of the final products or system manufactured by you.
10. Please contact a Renesas Electronics sales office for details as to environmental matters such as the environmental compatibility of each Renesas Electronics product. Please use Renesas Electronics products in compliance with all applicable laws and regulations that regulate the inclusion or use of controlled substances, including without limitation, the EU RoHS Directive. Renesas Electronics assumes no liability for damages or losses occurring as a result of your noncompliance with applicable laws and regulations.
11. This document may not be reproduced or duplicated, in any form, in whole or in part, without prior written consent of Renesas Electronics.
12. Please contact a Renesas Electronics sales office if you have any questions regarding the information contained in this document or Renesas Electronics products, or if you have any other inquiries.

(Note 1) “Renesas Electronics” as used in this document means Renesas Electronics Corporation and also includes its majority-owned subsidiaries.

(Note 2) “Renesas Electronics product(s)” means any product developed or manufactured by or for Renesas Electronics.

NPN SILICON RF TRANSISTOR  
**2SC5750**

NPN SILICON RF TRANSISTOR FOR  
 MEDIUM OUTPUT POWER AMPLIFICATION (30 mW)  
 4-PIN SUPER MINIMOLD

**FEATURES**

- Ideal for medium output power amplification
- $P_{O(1\text{ dB})} = 15.0\text{ dBm TYP. @ } V_{CE} = 2.8\text{ V, } f = 1.8\text{ GHz, } P_{in} = 1\text{ dBm}$
- HFT3 technology ( $f_T = 12\text{ GHz}$ ) adopted
- High reliability through use of gold electrodes
- 4-pin super minimold package

**ORDERING INFORMATION**

Part Number	Quantity	Supplying Form
2SC5750	50 pcs (Non reel)	• 8 mm wide embossed taping • Pin 3 (Base), Pin 4 (Emitter) face the perforation side of the tape
2SC5750-T1	3 kpcs/reel	

**Remark** To order evaluation samples, consult your NEC sales representative.  
 Unit sample quantity is 50 pcs.

**ABSOLUTE MAXIMUM RATINGS ( $T_A = +25^\circ\text{C}$ )**

Parameter	Symbol	Ratings	Unit
Collector to Base Voltage	$V_{CBO}$	9.0	V
Collector to Emitter Voltage	$V_{CEO}$	6.0	V
Emitter to Base Voltage	$V_{EBO}$	2.0	V
Collector Current	$I_C$	50	mA
Total Power Dissipation	$P_{tot}^{\text{Note}}$	200	mW
Junction Temperature	$T_j$	150	$^\circ\text{C}$
Storage Temperature	$T_{stg}$	-65 to +150	$^\circ\text{C}$

**Note** Mounted on  $1.08\text{ cm}^2 \times 1.0\text{ mm}$  (t) glass epoxy PCB

**Because this product uses high-frequency technology, avoid excessive static electricity, etc.**

The information in this document is subject to change without notice. Before using this document, please confirm that this is the latest version.  
 Not all devices/types available in every country. Please check with local NEC representative for availability and additional information.

**THERMAL RESISTANCE**

Parameter	Symbol	Value	Unit
Junction to Ambient Resistance	$R_{th\ j-a}$ <sup>Note</sup>	610	°C/W

**Note** Mounted on 1.08 cm<sup>2</sup> × 1.0 mm (t) glass epoxy PCB

**ELECTRICAL CHARACTERISTICS (T<sub>A</sub> = +25°C)**

Parameter	Symbol	Test Conditions	MIN.	TYP.	MAX.	Unit
DC Characteristics						
Collector Cut-off Current	$I_{CBO}$	$V_{CB} = 5\text{ V}, I_E = 0\text{ mA}$	–	–	100	nA
Emitter Cut-off Current	$I_{EBO}$	$V_{BE} = 1\text{ V}, I_C = 0\text{ mA}$	–	–	100	nA
DC Current Gain	$h_{FE}$ <sup>Note 1</sup>	$V_{CE} = 3\text{ V}, I_C = 20\text{ mA}$	75	120	150	–
RF Characteristics						
Gain Bandwidth Product	$f_T$	$V_{CE} = 3\text{ V}, I_C = 20\text{ mA}, f = 2\text{ GHz}$	–	15.0	–	GHz
Insertion Power Gain	$ S_{21e} ^2$	$V_{CE} = 3\text{ V}, I_C = 20\text{ mA}, f = 2\text{ GHz}$	10.0	13.0	–	dB
Noise Figure	NF	$V_{CE} = 3\text{ V}, I_C = 5\text{ mA}, f = 2\text{ GHz}, Z_S = Z_{opt}$	–	1.7	2.5	dB
Reverse Transfer Capacitance	$C_{re}$ <sup>Note 2</sup>	$V_{CB} = 3\text{ V}, I_E = 0\text{ mA}, f = 1\text{ MHz}$	–	0.26	0.5	pF
Maximum Available Power Gain	MAG <sup>Note 3</sup>	$V_{CE} = 3\text{ V}, I_C = 20\text{ mA}, f = 2\text{ GHz}$	–	15.0	–	dB
Linear Gain	$G_L$	$V_{CE} = 2.8\text{ V}, I_{Cq} = 8\text{ mA}, f = 1.8\text{ GHz}, P_{in} = -10\text{ dBm}$	–	14.5	–	dB
Gain 1 dB Compression Output Power	$P_{O(1\text{ dB})}$	$V_{CE} = 2.8\text{ V}, I_{Cq} = 8\text{ mA}, f = 1.8\text{ GHz}, P_{in} = 1\text{ dBm}$	–	15.0	–	dBm
Collector Efficiency	$\eta_C$	$V_{CE} = 2.8\text{ V}, I_{Cq} = 8\text{ mA}, f = 1.8\text{ GHz}, P_{in} = 1\text{ dBm}$	–	50	–	%

- Notes** 1. Pulse measurement: PW ≤ 350 μs, Duty Cycle ≤ 2%  
 2. Collector to base capacitance when the emitter grounded

$$3. \text{MAG} = \left| \frac{S_{21}}{S_{12}} \right| (K - \sqrt{K^2 - 1})$$

**h<sub>FE</sub> CLASSIFICATION**

Rank	FB
Marking	R54
h <sub>FE</sub> Value	75 to 150

**TYPICAL CHARACTERISTICS (Unless otherwise specified,  $T_A = +25^\circ\text{C}$ )**

**TOTAL POWER DISSIPATION vs. AMBIENT TEMPERATURE**

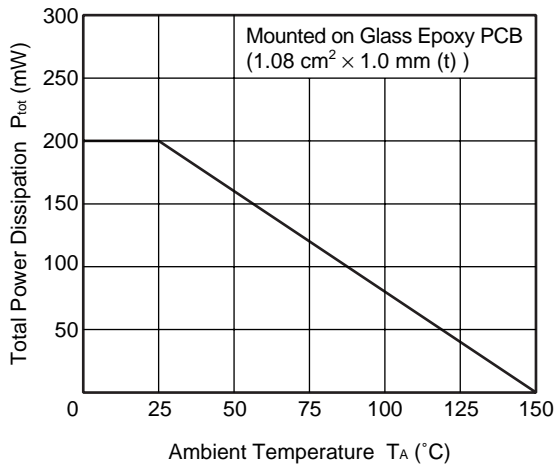

**REVERSE TRANSFER CAPACITANCE vs. COLLECTOR TO BASE VOLTAGE**

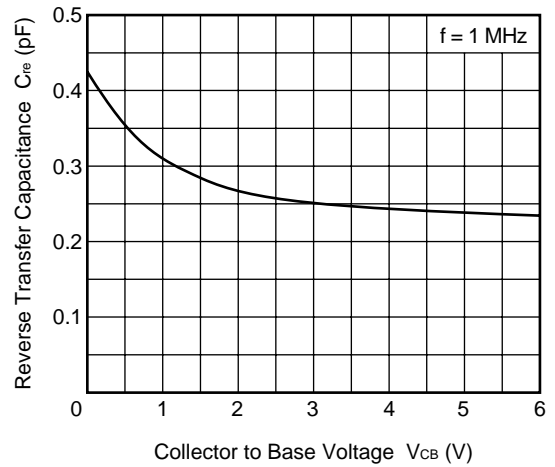

**COLLECTOR CURRENT vs. BASE TO EMITTER VOLTAGE**

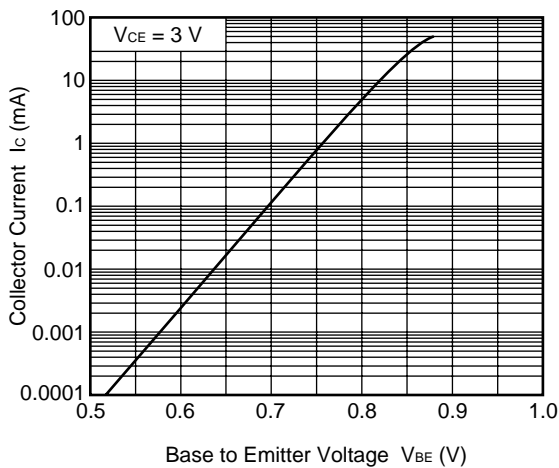

**COLLECTOR CURRENT vs. COLLECTOR TO EMITTER VOLTAGE**

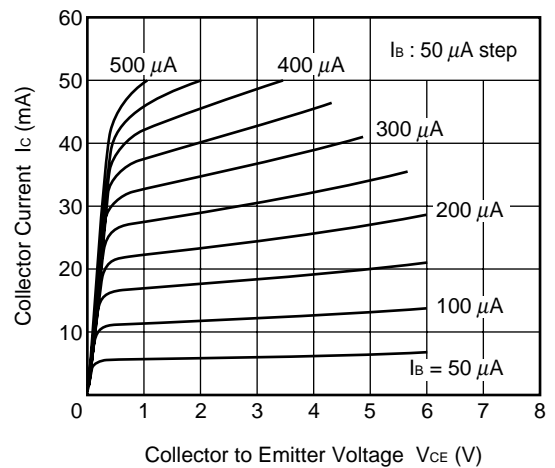

**DC CURRENT GAIN vs. COLLECTOR CURRENT**

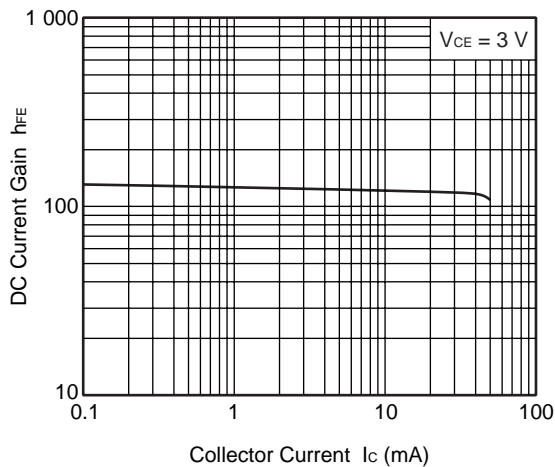

GAIN BANDWIDTH PRODUCT vs. COLLECTOR CURRENT

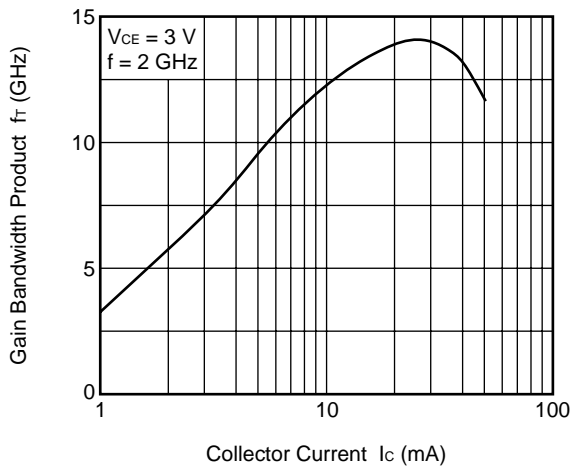

INSERTION POWER GAIN, MAG, MSG vs. FREQUENCY

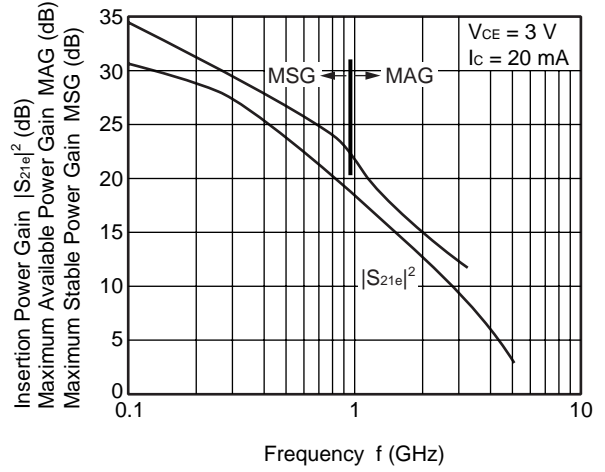

INSERTION POWER GAIN, MAG, MSG vs. COLLECTOR CURRENT

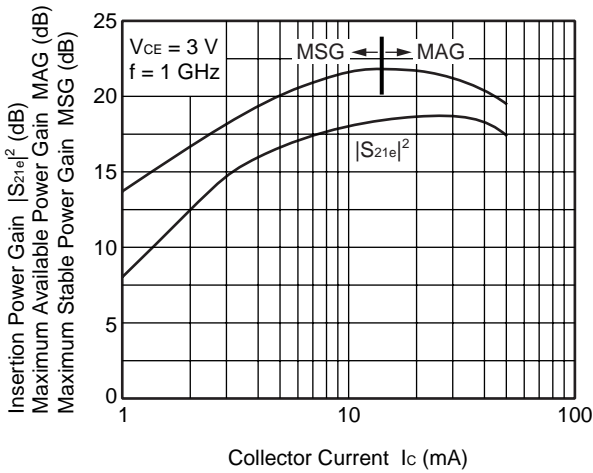

INSERTION POWER GAIN, MAG, MSG vs. COLLECTOR CURRENT

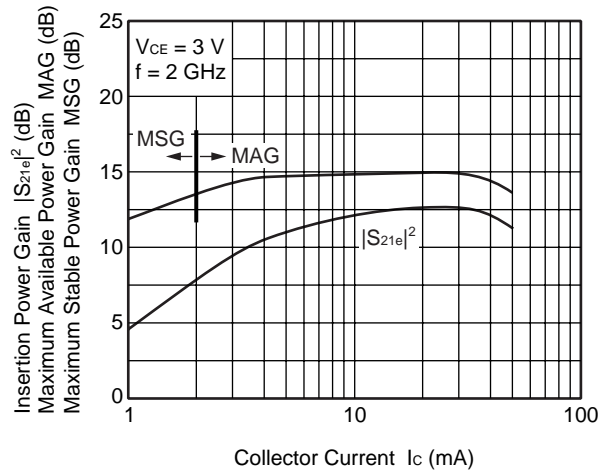

INSERTION POWER GAIN, MAG vs. COLLECTOR CURRENT

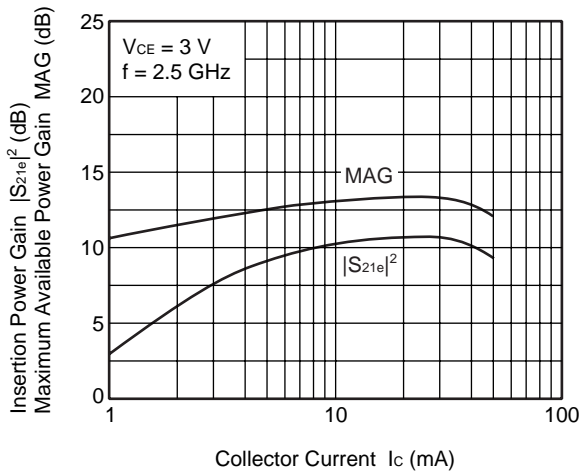

OUTPUT POWER, POWER GAIN, COLLECTOR CURRENT, COLLECTOR EFFICIENCY vs. INPUT POWER

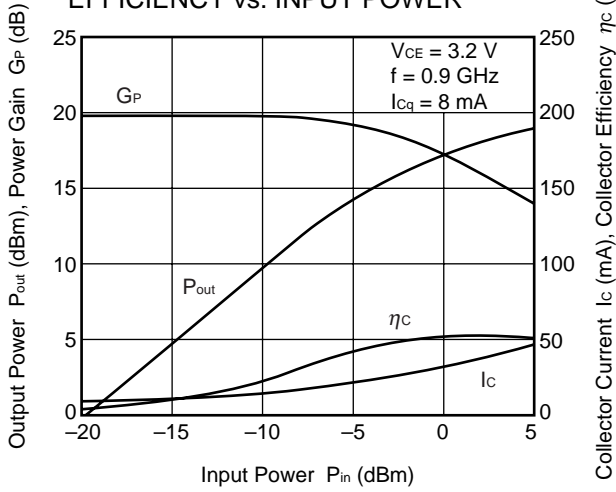

OUTPUT POWER, POWER GAIN, COLLECTOR CURRENT, COLLECTOR EFFICIENCY vs. INPUT POWER

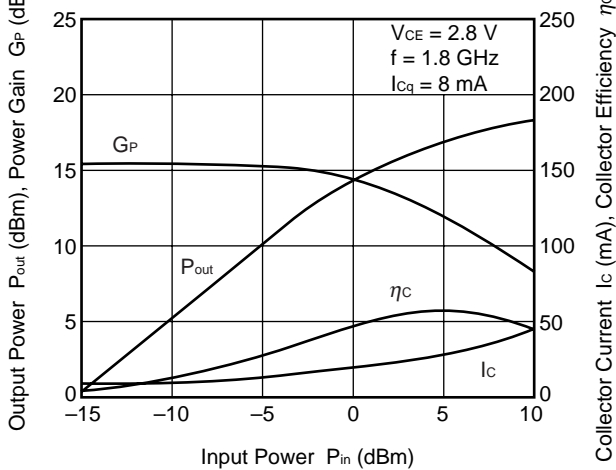

OUTPUT POWER, POWER GAIN, COLLECTOR CURRENT, COLLECTOR EFFICIENCY vs. INPUT POWER

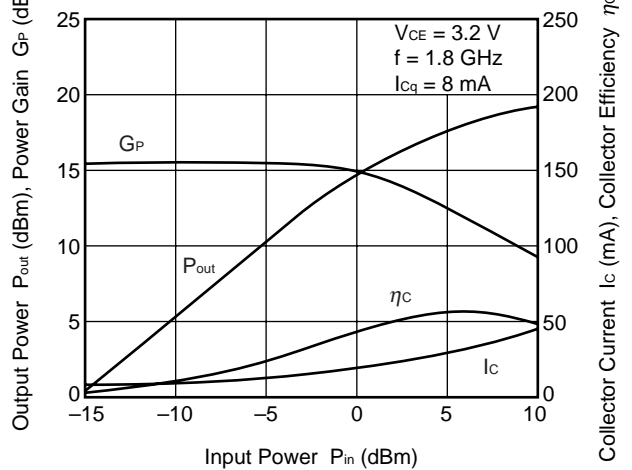

OUTPUT POWER, POWER GAIN, COLLECTOR CURRENT, COLLECTOR EFFICIENCY vs. INPUT POWER

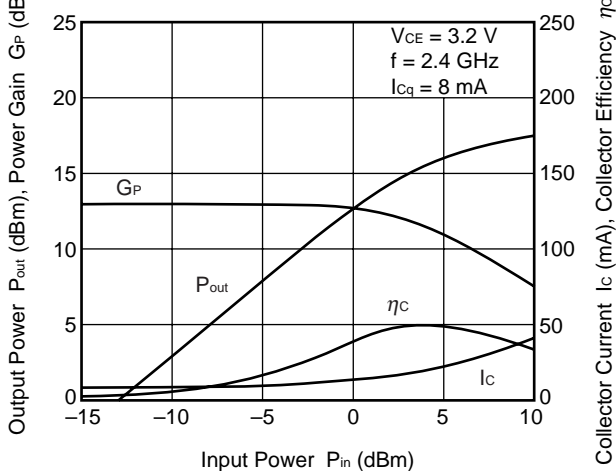

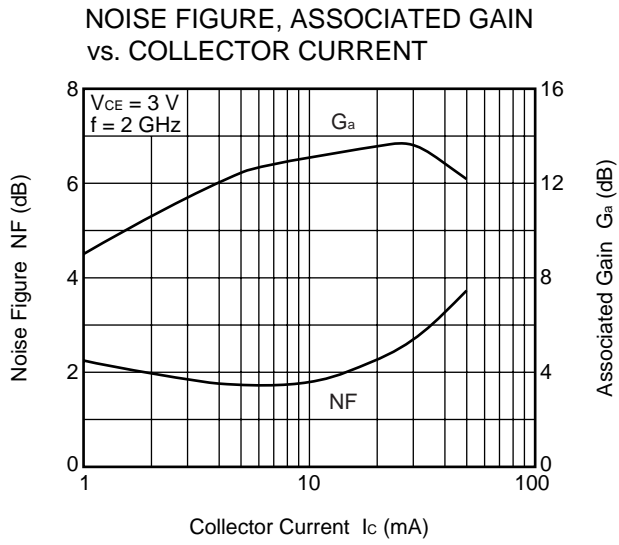

**Remark** The graphs indicate nominal characteristics.



S-PARAMETERS

**Note** When  $K \geq 1$ , the MAG (Maximum Available Power Gain) is used.  $MAG = \left| \frac{S_{21}}{S_{12}} \right| (K - \sqrt{K^2 - 1})$

When  $K < 1$ , the MSG (Maximum Stable Power Gain) is used.  $MSG = \left| \frac{S_{21}}{S_{12}} \right|$

$V_{CE} = 3\text{ V}$ ,  $I_C = 1\text{ mA}$ ,  $Z_O = 50\ \Omega$

Frequency (GHz)	S <sub>11</sub>		S <sub>21</sub>		S <sub>12</sub>		S <sub>22</sub>		K	MAG/MSG (dB)
	MAG.	ANG. (deg.)	MAG.	ANG. (deg.)	MAG.	ANG. (deg.)	MAG.	ANG. (deg.)		
0.1	0.975	-8.7	3.412	172.7	0.017	83.0	1.004	-4.9	0.037	23.02
0.2	0.963	-18.3	3.339	164.4	0.032	76.6	0.991	-10.2	0.068	20.19
0.3	0.949	-28.6	3.332	155.8	0.047	70.3	0.989	-15.2	0.087	18.50
0.4	0.927	-37.6	3.232	148.0	0.061	63.7	0.968	-20.3	0.128	17.24
0.5	0.901	-46.1	3.144	140.6	0.074	57.3	0.956	-25.2	0.163	16.30
0.6	0.875	-55.0	3.024	133.5	0.085	51.1	0.926	-29.9	0.200	15.54
0.7	0.845	-63.7	2.920	126.5	0.094	46.0	0.905	-34.3	0.226	14.91
0.8	0.819	-71.6	2.785	120.0	0.101	40.5	0.873	-38.7	0.270	14.40
0.9	0.793	-79.7	2.692	113.7	0.108	35.7	0.854	-42.6	0.298	13.96
1.0	0.764	-87.4	2.583	107.3	0.112	31.3	0.826	-46.7	0.343	13.61
1.1	0.745	-95.4	2.485	101.5	0.117	26.8	0.812	-50.5	0.363	13.29
1.2	0.720	-102.9	2.376	96.0	0.119	22.8	0.789	-54.4	0.402	13.00
1.3	0.701	-110.4	2.292	90.3	0.121	18.5	0.778	-58.1	0.429	12.77
1.4	0.684	-117.5	2.190	84.9	0.122	14.9	0.760	-61.9	0.472	12.55
1.5	0.672	-124.7	2.106	79.7	0.122	11.4	0.751	-65.7	0.492	12.36
1.6	0.655	-131.2	2.016	74.4	0.121	7.9	0.733	-69.5	0.555	12.21
1.7	0.648	-137.7	1.939	69.4	0.120	4.8	0.725	-73.4	0.584	12.10
1.8	0.639	-143.8	1.845	64.6	0.117	2.0	0.709	-77.3	0.653	12.00
1.9	0.636	-150.3	1.776	59.8	0.114	-0.7	0.707	-81.4	0.675	11.92
2.0	0.630	-155.9	1.695	54.9	0.111	-2.8	0.692	-85.2	0.757	11.84
2.1	0.633	-161.3	1.637	50.5	0.107	-4.4	0.697	-89.7	0.765	11.83
2.2	0.628	-166.5	1.563	46.0	0.103	-5.7	0.688	-93.3	0.858	11.83
2.3	0.626	-171.5	1.510	41.8	0.098	-6.9	0.693	-97.8	0.900	11.89
2.4	0.627	-176.2	1.447	37.6	0.093	-7.9	0.687	-101.6	1.001	11.71
2.5	0.631	179.3	1.391	33.6	0.088	-8.0	0.692	-106.1	1.049	10.64
2.6	0.633	175.1	1.329	29.7	0.083	-7.9	0.690	-110.0	1.156	9.64
2.7	0.638	170.8	1.280	25.7	0.079	-6.8	0.692	-114.3	1.233	9.20
2.8	0.644	167.0	1.227	22.2	0.074	-5.0	0.693	-117.8	1.334	8.71
2.9	0.651	163.8	1.181	18.9	0.071	-3.2	0.694	-121.6	1.412	8.38
3.0	0.651	159.9	1.133	15.6	0.068	0.0	0.687	-125.7	1.578	7.73
4.0	0.727	129.8	0.752	-15.0	0.087	28.6	0.756	-167.7	1.241	6.43

$V_{CE} = 3\text{ V}$ ,  $I_C = 3\text{ mA}$ ,  $Z_o = 50\ \Omega$

Frequency (GHz)	S <sub>11</sub>		S <sub>21</sub>		S <sub>12</sub>		S <sub>22</sub>		K	MAG/MSG (dB)
	MAG.	ANG. (deg.)	MAG.	ANG. (deg.)	MAG.	ANG. (deg.)	MAG.	ANG. (deg.)		
0.1	0.902	-14.3	9.818	169.5	0.016	80.5	0.994	-8.0	0.050	27.85
0.2	0.883	-28.6	9.364	157.6	0.030	71.3	0.959	-16.2	0.119	24.91
0.3	0.842	-43.1	8.967	146.7	0.043	63.9	0.928	-23.5	0.147	23.19
0.4	0.796	-55.6	8.390	137.2	0.054	56.5	0.874	-30.4	0.203	21.95
0.5	0.751	-67.3	7.834	128.7	0.062	49.8	0.829	-36.3	0.252	21.03
0.6	0.709	-78.4	7.219	121.0	0.068	44.0	0.773	-41.6	0.308	20.27
0.7	0.667	-88.9	6.699	113.8	0.073	39.7	0.730	-46.1	0.354	19.61
0.8	0.631	-98.3	6.183	107.4	0.076	35.6	0.682	-50.5	0.418	19.11
0.9	0.606	-107.2	5.767	101.5	0.079	32.2	0.650	-54.2	0.461	18.63
1.0	0.582	-115.6	5.382	95.9	0.081	29.5	0.615	-57.9	0.518	18.24
1.1	0.566	-123.9	5.039	90.7	0.082	27.0	0.593	-61.3	0.557	17.89
1.2	0.547	-131.5	4.700	86.2	0.083	25.0	0.567	-64.7	0.618	17.54
1.3	0.539	-139.0	4.445	81.3	0.083	22.9	0.551	-67.9	0.658	17.28
1.4	0.529	-145.6	4.168	76.7	0.083	21.4	0.531	-71.4	0.719	16.99
1.5	0.527	-152.4	3.950	72.5	0.084	20.2	0.520	-74.7	0.756	16.75
1.6	0.519	-158.3	3.730	68.2	0.083	19.2	0.502	-78.2	0.824	16.51
1.7	0.520	-164.0	3.542	64.2	0.083	18.4	0.495	-81.7	0.868	16.32
1.8	0.519	-169.3	3.348	60.4	0.082	17.9	0.480	-85.2	0.940	16.11
1.9	0.521	-174.4	3.186	56.5	0.082	17.6	0.477	-88.9	0.981	15.91
2.0	0.524	-179.2	3.024	52.5	0.082	17.6	0.467	-92.7	1.039	14.47
2.1	0.530	176.3	2.901	48.9	0.081	18.2	0.471	-96.9	1.064	13.99
2.2	0.533	172.3	2.763	45.3	0.081	18.8	0.464	-100.5	1.126	13.19
2.3	0.538	168.3	2.655	41.8	0.080	19.6	0.471	-104.7	1.148	12.85
2.4	0.546	164.7	2.538	38.3	0.080	20.2	0.467	-108.2	1.196	12.33
2.5	0.551	161.2	2.441	34.9	0.080	21.0	0.473	-112.3	1.221	12.00
2.6	0.556	158.0	2.340	31.7	0.081	21.9	0.472	-115.9	1.261	11.55
2.7	0.565	154.4	2.245	28.4	0.081	23.2	0.478	-119.9	1.273	11.27
2.8	0.571	151.6	2.152	25.3	0.082	24.4	0.480	-123.3	1.301	10.90
2.9	0.581	149.3	2.077	22.3	0.083	25.3	0.485	-126.9	1.292	10.71
3.0	0.584	146.4	2.005	19.3	0.085	26.4	0.484	-130.8	1.321	10.32
4.0	0.676	122.6	1.396	-9.7	0.115	28.8	0.581	-170.2	1.046	9.54

$V_{CE} = 3\text{ V}$ ,  $I_C = 5\text{ mA}$ ,  $Z_o = 50\ \Omega$

Frequency (GHz)	S <sub>11</sub>		S <sub>21</sub>		S <sub>12</sub>		S <sub>22</sub>		K	MAG/MSG (dB)
	MAG.	ANG. (deg.)	MAG.	ANG. (deg.)	MAG.	ANG. (deg.)	MAG.	ANG. (deg.)		
0.1	0.841	-17.9	14.947	166.5	0.015	79.2	0.983	-10.6	0.075	29.91
0.2	0.806	-36.5	13.885	152.5	0.029	68.6	0.926	-20.8	0.153	26.83
0.3	0.759	-54.0	12.871	140.2	0.039	60.0	0.870	-29.5	0.197	25.18
0.4	0.702	-68.8	11.663	130.0	0.048	53.0	0.796	-37.0	0.266	23.90
0.5	0.649	-81.9	10.559	121.2	0.053	46.9	0.732	-43.0	0.335	22.97
0.6	0.607	-93.9	9.507	113.6	0.057	42.0	0.667	-48.2	0.405	22.19
0.7	0.569	-105.1	8.627	106.7	0.061	38.9	0.617	-52.4	0.469	21.50
0.8	0.542	-114.4	7.828	100.9	0.063	36.2	0.570	-56.3	0.540	20.94
0.9	0.521	-123.4	7.202	95.3	0.065	34.0	0.538	-59.6	0.598	20.44
1.0	0.506	-131.9	6.627	90.3	0.067	32.6	0.505	-63.1	0.659	19.98
1.1	0.495	-139.9	6.156	85.6	0.068	31.4	0.484	-66.2	0.708	19.57
1.2	0.486	-146.8	5.700	81.4	0.069	30.5	0.460	-69.5	0.773	19.17
1.3	0.483	-153.9	5.338	77.0	0.070	29.4	0.445	-72.6	0.819	18.83
1.4	0.480	-160.0	4.995	73.1	0.071	29.1	0.428	-75.7	0.874	18.48
1.5	0.483	-165.8	4.689	69.2	0.072	28.7	0.419	-78.9	0.916	18.16
1.6	0.481	-171.2	4.420	65.6	0.073	28.8	0.404	-82.2	0.974	17.85
1.7	0.486	-176.3	4.183	61.9	0.073	28.7	0.399	-85.7	1.008	16.99
1.8	0.490	179.1	3.952	58.4	0.074	29.1	0.386	-89.4	1.058	15.78
1.9	0.494	174.6	3.746	54.9	0.076	28.8	0.386	-93.3	1.087	15.15
2.0	0.498	170.6	3.559	51.3	0.077	29.3	0.376	-97.1	1.132	14.45
2.1	0.509	167.0	3.400	48.1	0.078	30.1	0.381	-101.4	1.134	14.16
2.2	0.513	163.0	3.239	44.8	0.079	30.4	0.376	-105.1	1.173	13.58
2.3	0.519	159.8	3.105	41.6	0.081	31.0	0.383	-109.3	1.182	13.26
2.4	0.526	156.4	2.969	38.3	0.082	31.4	0.381	-112.9	1.212	12.81
2.5	0.533	153.4	2.853	35.2	0.084	31.8	0.389	-117.0	1.210	12.55
2.6	0.541	150.6	2.732	32.3	0.086	32.1	0.389	-120.4	1.225	12.17
2.7	0.550	147.6	2.628	29.3	0.088	32.7	0.395	-124.5	1.223	11.92
2.8	0.558	145.2	2.517	26.3	0.090	33.1	0.398	-127.8	1.231	11.58
2.9	0.570	143.1	2.430	23.5	0.092	33.2	0.405	-131.5	1.212	11.44
3.0	0.572	140.4	2.355	20.7	0.095	33.5	0.404	-135.3	1.223	11.11
4.0	0.665	119.1	1.663	-6.9	0.126	29.5	0.511	-173.5	1.013	10.51

$V_{CE} = 3\text{ V}$ ,  $I_C = 8\text{ mA}$ ,  $Z_o = 50\ \Omega$

Frequency (GHz)	S <sub>11</sub>		S <sub>21</sub>		S <sub>12</sub>		S <sub>22</sub>		K	MAG/MSG (dB)
	MAG.	ANG. (deg.)	MAG.	ANG. (deg.)	MAG.	ANG. (deg.)	MAG.	ANG. (deg.)		
0.1	0.773	-23.1	20.891	163.0	0.014	73.3	0.964	-13.5	0.159	31.62
0.2	0.725	-45.9	18.751	147.0	0.026	64.6	0.881	-26.0	0.205	28.58
0.3	0.664	-66.5	16.735	133.4	0.035	56.4	0.797	-35.5	0.271	26.77
0.4	0.605	-82.9	14.645	123.0	0.041	50.6	0.705	-43.2	0.355	25.51
0.5	0.557	-97.3	12.886	114.2	0.045	46.1	0.633	-48.8	0.436	24.53
0.6	0.523	-109.8	11.343	107.2	0.049	42.6	0.566	-53.7	0.521	23.69
0.7	0.498	-120.9	10.128	100.8	0.051	40.6	0.519	-57.2	0.593	22.97
0.8	0.477	-130.1	9.065	95.4	0.053	39.1	0.474	-60.7	0.678	22.32
0.9	0.465	-138.7	8.267	90.4	0.055	38.4	0.445	-63.7	0.735	21.76
1.0	0.459	-146.5	7.541	85.9	0.057	37.9	0.416	-66.9	0.801	21.23
1.1	0.455	-153.6	6.956	81.8	0.059	37.5	0.397	-69.8	0.851	20.74
1.2	0.450	-160.0	6.417	78.0	0.061	37.5	0.377	-73.2	0.908	20.26
1.3	0.453	-166.3	5.977	74.0	0.062	37.3	0.367	-76.0	0.946	19.83
1.4	0.453	-171.7	5.571	70.4	0.064	37.4	0.352	-79.3	0.996	19.40
1.5	0.462	-176.9	5.223	67.0	0.066	37.6	0.345	-82.5	1.019	18.15
1.6	0.461	178.4	4.912	63.4	0.068	37.8	0.332	-85.9	1.069	17.00
1.7	0.469	174.2	4.643	60.3	0.070	38.0	0.328	-89.6	1.090	16.42
1.8	0.476	170.4	4.374	57.0	0.072	38.1	0.317	-93.3	1.120	15.74
1.9	0.481	166.2	4.150	53.8	0.074	38.0	0.318	-97.5	1.137	15.24
2.0	0.489	162.6	3.931	50.5	0.076	38.2	0.311	-101.5	1.159	14.69
2.1	0.500	159.5	3.756	47.4	0.079	38.7	0.316	-106.0	1.159	14.38
2.2	0.508	156.3	3.574	44.4	0.081	38.8	0.314	-109.9	1.168	13.95
2.3	0.511	153.4	3.425	41.5	0.083	38.7	0.322	-114.2	1.179	13.58
2.4	0.520	150.5	3.277	38.4	0.085	38.8	0.321	-117.9	1.192	13.19
2.5	0.530	147.8	3.149	35.4	0.088	38.8	0.329	-122.0	1.177	12.98
2.6	0.534	145.1	3.014	32.8	0.091	38.6	0.330	-125.5	1.188	12.57
2.7	0.545	142.7	2.900	29.8	0.093	38.6	0.338	-129.6	1.180	12.35
2.8	0.553	140.1	2.780	27.1	0.096	38.5	0.341	-132.9	1.182	12.02
2.9	0.565	138.6	2.689	24.3	0.099	38.0	0.349	-136.6	1.157	11.93
3.0	0.567	136.1	2.606	21.6	0.102	37.8	0.350	-140.4	1.166	11.61

$V_{CE} = 3\text{ V}$ ,  $I_C = 10\text{ mA}$ ,  $Z_O = 50\ \Omega$

Frequency (GHz)	S <sub>11</sub>		S <sub>21</sub>		S <sub>12</sub>		S <sub>22</sub>		K	MAG/MSG (dB)
	MAG.	ANG. (deg.)	MAG.	ANG. (deg.)	MAG.	ANG. (deg.)	MAG.	ANG. (deg.)		
0.1	0.736	-26.3	24.160	161.1	0.013	73.2	0.953	-15.3	0.155	32.56
0.2	0.679	-51.6	21.264	144.1	0.025	63.4	0.854	-28.6	0.228	29.28
0.3	0.613	-73.4	18.533	130.1	0.033	55.1	0.757	-38.4	0.314	27.50
0.4	0.560	-90.4	15.925	119.7	0.038	50.5	0.659	-46.0	0.403	26.20
0.5	0.518	-105.3	13.847	111.1	0.042	46.1	0.587	-51.3	0.493	25.20
0.6	0.489	-117.7	12.072	104.3	0.045	43.2	0.520	-55.8	0.587	24.33
0.7	0.470	-128.5	10.714	98.3	0.047	42.3	0.475	-59.1	0.659	23.55
0.8	0.454	-137.3	9.551	93.2	0.049	41.4	0.433	-62.5	0.745	22.89
0.9	0.447	-145.8	8.674	88.5	0.051	40.9	0.405	-65.4	0.802	22.27
1.0	0.441	-153.2	7.902	84.1	0.053	41.1	0.378	-68.6	0.868	21.71
1.1	0.441	-159.9	7.264	80.2	0.055	40.8	0.362	-71.3	0.912	21.17
1.2	0.440	-165.8	6.693	76.5	0.058	41.3	0.344	-74.7	0.963	20.65
1.3	0.446	-171.6	6.237	72.8	0.060	41.2	0.335	-77.5	0.993	20.20
1.4	0.447	-176.5	5.796	69.4	0.062	41.4	0.320	-80.9	1.039	18.51
1.5	0.457	178.4	5.428	66.0	0.064	41.7	0.315	-83.9	1.058	17.81
1.6	0.458	174.2	5.094	62.6	0.067	41.8	0.303	-87.6	1.096	16.95
1.7	0.466	170.2	4.823	59.5	0.069	41.6	0.300	-91.3	1.107	16.45
1.8	0.471	166.4	4.530	56.5	0.071	41.8	0.291	-95.2	1.145	15.73
1.9	0.481	162.8	4.303	53.3	0.074	41.5	0.292	-99.6	1.143	15.35
2.0	0.488	159.4	4.076	50.1	0.077	41.7	0.286	-103.7	1.162	14.81
2.1	0.499	156.7	3.892	47.1	0.079	41.9	0.292	-108.3	1.158	14.50
2.2	0.505	153.2	3.705	44.2	0.082	41.8	0.290	-112.3	1.171	14.04
2.3	0.510	150.8	3.546	41.3	0.085	41.7	0.298	-116.6	1.171	13.71
2.4	0.518	148.2	3.392	38.3	0.087	41.8	0.298	-120.4	1.178	13.34
2.5	0.528	145.6	3.260	35.5	0.090	41.4	0.307	-124.4	1.166	13.10
2.6	0.535	143.0	3.123	32.7	0.093	41.0	0.308	-128.0	1.166	12.77
2.7	0.545	140.6	3.003	30.0	0.096	40.7	0.316	-132.1	1.161	12.52
2.8	0.555	138.2	2.882	27.3	0.099	40.3	0.320	-135.4	1.157	12.24
2.9	0.565	136.7	2.781	24.6	0.102	39.9	0.329	-139.1	1.140	12.08
3.0	0.568	134.3	2.698	22.0	0.105	39.3	0.329	-143.0	1.147	11.78

$V_{CE} = 3\text{ V}$ ,  $I_C = 20\text{ mA}$ ,  $Z_O = 50\ \Omega$

Frequency (GHz)	S <sub>11</sub>		S <sub>21</sub>		S <sub>12</sub>		S <sub>22</sub>		K	MAG/MSG (dB)
	MAG.	ANG. (deg.)	MAG.	ANG. (deg.)	MAG.	ANG. (deg.)	MAG.	ANG. (deg.)		
0.1	0.598	-38.9	34.342	154.8	0.012	67.4	0.905	-20.6	0.240	34.40
0.2	0.536	-70.7	28.001	134.8	0.021	60.1	0.757	-36.1	0.340	31.21
0.3	0.490	-96.4	22.823	120.7	0.027	53.4	0.633	-45.8	0.455	29.34
0.4	0.459	-114.3	18.739	111.0	0.030	50.3	0.531	-52.5	0.576	27.91
0.5	0.438	-128.9	15.793	103.4	0.033	49.2	0.463	-56.6	0.680	26.77
0.6	0.427	-140.0	13.493	97.4	0.036	48.5	0.405	-60.1	0.779	25.74
0.7	0.422	-149.6	11.820	92.2	0.039	49.5	0.368	-62.6	0.849	24.83
0.8	0.418	-157.1	10.435	87.8	0.041	49.6	0.334	-65.6	0.924	24.01
0.9	0.420	-163.7	9.421	83.6	0.044	49.9	0.314	-68.0	0.966	23.28
1.0	0.420	-169.7	8.537	79.8	0.047	50.6	0.294	-71.2	1.019	21.76
1.1	0.426	-175.0	7.812	76.3	0.050	50.8	0.282	-73.8	1.043	20.66
1.2	0.429	-179.6	7.177	73.1	0.053	51.1	0.269	-77.4	1.077	19.62
1.3	0.439	175.9	6.654	69.7	0.056	51.0	0.263	-80.1	1.093	18.90
1.4	0.441	171.8	6.190	66.6	0.059	51.1	0.252	-84.0	1.117	18.12
1.5	0.453	167.9	5.770	63.5	0.062	51.2	0.250	-87.2	1.122	17.54
1.6	0.458	164.3	5.422	60.4	0.066	50.8	0.241	-91.2	1.138	16.92
1.7	0.468	161.2	5.117	57.6	0.069	50.7	0.240	-95.3	1.139	16.45
1.8	0.475	158.2	4.824	54.8	0.072	50.2	0.233	-99.7	1.152	15.90
1.9	0.484	154.9	4.564	51.9	0.075	49.7	0.237	-104.4	1.152	15.46
2.0	0.493	151.9	4.323	48.8	0.079	49.2	0.234	-109.1	1.158	15.00
2.1	0.501	149.9	4.122	46.2	0.082	48.8	0.241	-113.9	1.151	14.66
2.2	0.510	147.2	3.922	43.5	0.085	48.6	0.241	-118.3	1.152	14.25
2.3	0.517	145.0	3.756	40.7	0.089	47.8	0.250	-122.7	1.147	13.95
2.4	0.526	142.5	3.587	37.9	0.092	47.4	0.252	-126.7	1.147	13.60
2.5	0.532	140.3	3.450	35.3	0.095	46.7	0.262	-130.7	1.140	13.33
2.6	0.541	138.3	3.303	32.7	0.099	45.8	0.265	-134.3	1.133	13.03
2.7	0.553	135.7	3.175	30.1	0.102	45.2	0.275	-138.4	1.125	12.80
2.8	0.560	134.0	3.048	27.5	0.105	44.5	0.278	-141.8	1.124	12.49
2.9	0.570	132.6	2.945	24.9	0.108	43.6	0.289	-145.5	1.104	12.38
3.0	0.576	130.3	2.857	22.4	0.111	42.8	0.291	-149.3	1.104	12.13

$V_{CE} = 3\text{ V}$ ,  $I_C = 30\text{ mA}$ ,  $Z_0 = 50\ \Omega$

Frequency (GHz)	S <sub>11</sub>		S <sub>21</sub>		S <sub>12</sub>		S <sub>22</sub>		K	MAG/MSG (dB)
	MAG.	ANG. (deg.)	MAG.	ANG. (deg.)	MAG.	ANG. (deg.)	MAG.	ANG. (deg.)		
0.1	0.496	-48.3	39.295	150.8	0.012	73.3	0.868	-23.6	0.245	35.08
0.2	0.466	-84.4	30.368	129.8	0.019	58.7	0.695	-39.6	0.420	32.02
0.3	0.446	-111.3	23.900	116.0	0.024	53.2	0.566	-48.4	0.548	30.05
0.4	0.431	-128.8	19.284	106.9	0.027	52.5	0.469	-54.3	0.676	28.51
0.5	0.417	-141.1	16.055	99.8	0.030	51.9	0.408	-57.4	0.784	27.25
0.6	0.417	-151.5	13.631	94.3	0.033	52.3	0.357	-60.4	0.882	26.20
0.7	0.420	-159.4	11.875	89.4	0.036	53.4	0.326	-62.3	0.937	25.17
0.8	0.419	-166.1	10.459	85.3	0.039	53.9	0.297	-65.1	1.009	23.73
0.9	0.423	-171.8	9.410	81.4	0.042	54.5	0.280	-67.3	1.042	22.26
1.0	0.426	-177.1	8.510	77.7	0.045	54.8	0.263	-70.5	1.080	21.03
1.1	0.432	178.3	7.780	74.4	0.048	55.1	0.254	-73.2	1.101	20.14
1.2	0.436	173.9	7.138	71.4	0.052	55.3	0.243	-76.8	1.126	19.25
1.3	0.447	170.5	6.612	68.1	0.055	55.3	0.239	-79.7	1.126	18.63
1.4	0.451	166.8	6.133	65.1	0.059	55.3	0.230	-83.7	1.147	17.87
1.5	0.462	163.4	5.731	62.1	0.062	54.8	0.229	-87.1	1.147	17.33
1.6	0.467	160.2	5.385	59.3	0.065	54.4	0.220	-91.4	1.158	16.74
1.7	0.478	157.4	5.071	56.4	0.069	54.1	0.222	-95.5	1.155	16.29
1.8	0.485	154.5	4.771	53.7	0.072	53.5	0.215	-100.2	1.167	15.72
1.9	0.494	151.8	4.524	50.8	0.076	52.7	0.220	-105.2	1.161	15.33
2.0	0.500	149.0	4.284	47.9	0.080	52.2	0.218	-110.1	1.164	14.84
2.1	0.511	146.9	4.087	45.2	0.083	51.7	0.226	-115.1	1.152	14.55
2.2	0.521	144.5	3.881	42.6	0.087	51.1	0.227	-119.6	1.152	14.14
2.3	0.528	142.4	3.717	39.9	0.090	50.3	0.237	-124.1	1.147	13.84
2.4	0.536	140.0	3.548	37.1	0.094	49.6	0.239	-128.3	1.145	13.48
2.5	0.545	138.2	3.413	34.5	0.097	48.7	0.250	-132.3	1.131	13.27
2.6	0.552	136.1	3.274	32.0	0.101	47.7	0.253	-136.0	1.127	12.96
2.7	0.561	133.8	3.141	29.4	0.104	47.0	0.264	-140.1	1.123	12.68
2.8	0.571	132.1	3.018	26.8	0.107	46.1	0.268	-143.5	1.114	12.44
2.9	0.581	130.8	2.912	24.2	0.111	45.2	0.279	-147.1	1.098	12.30
3.0	0.582	128.8	2.825	21.9	0.114	44.3	0.282	-151.0	1.104	11.99

$V_{CE} = 3\text{ V}$ ,  $I_C = 40\text{ mA}$ ,  $Z_O = 50\ \Omega$

Frequency (GHz)	S <sub>11</sub>		S <sub>21</sub>		S <sub>12</sub>		S <sub>22</sub>		K	MAG/MSG (dB)
	MAG.	ANG. (deg.)	MAG.	ANG. (deg.)	MAG.	ANG. (deg.)	MAG.	ANG. (deg.)		
0.1	0.460	-56.0	41.115	147.7	0.011	66.0	0.833	-25.6	0.331	35.89
0.2	0.435	-96.7	30.636	126.2	0.018	59.4	0.646	-41.3	0.474	32.21
0.3	0.428	-122.5	23.535	112.7	0.022	54.6	0.519	-49.2	0.626	30.26
0.4	0.422	-138.4	18.755	104.1	0.026	53.7	0.428	-54.0	0.762	28.66
0.5	0.422	-150.2	15.507	97.3	0.028	54.0	0.374	-56.4	0.868	27.39
0.6	0.424	-159.0	13.095	92.1	0.031	54.5	0.329	-58.9	0.967	26.27
0.7	0.429	-166.6	11.399	87.4	0.034	55.7	0.302	-60.5	1.012	24.51
0.8	0.431	-172.0	10.015	83.5	0.038	56.6	0.277	-63.0	1.072	22.62
0.9	0.437	-177.1	9.006	79.7	0.041	56.9	0.263	-65.2	1.099	21.52
1.0	0.440	178.1	8.126	76.2	0.044	57.3	0.249	-68.3	1.132	20.43
1.1	0.447	173.9	7.424	72.9	0.047	57.7	0.242	-71.1	1.149	19.60
1.2	0.453	170.4	6.814	70.0	0.051	57.7	0.232	-74.8	1.167	18.78
1.3	0.461	166.7	6.300	66.7	0.055	57.4	0.229	-77.9	1.171	18.12
1.4	0.467	163.4	5.850	63.8	0.058	57.4	0.221	-81.8	1.186	17.43
1.5	0.477	160.4	5.461	61.0	0.062	57.0	0.221	-85.4	1.182	16.89
1.6	0.482	157.4	5.122	58.0	0.065	56.6	0.214	-89.7	1.190	16.30
1.7	0.493	154.9	4.833	55.3	0.069	56.0	0.216	-94.1	1.184	15.87
1.8	0.500	152.1	4.546	52.4	0.072	55.4	0.211	-99.0	1.192	15.33
1.9	0.512	149.5	4.300	49.6	0.076	54.3	0.216	-104.0	1.179	14.95
2.0	0.516	146.8	4.075	46.7	0.080	53.8	0.214	-109.1	1.190	14.45
2.1	0.527	145.0	3.886	44.0	0.084	53.3	0.223	-114.3	1.174	14.15
2.2	0.535	142.5	3.694	41.4	0.087	52.5	0.224	-118.8	1.175	13.75
2.3	0.542	140.6	3.531	38.7	0.091	51.6	0.235	-123.5	1.162	13.45
2.4	0.549	138.4	3.373	35.9	0.094	50.9	0.238	-127.7	1.165	13.08
2.5	0.559	136.5	3.247	33.2	0.098	50.1	0.249	-131.8	1.147	12.89
2.6	0.566	134.3	3.107	30.7	0.101	49.0	0.252	-135.6	1.145	12.56
2.7	0.576	132.4	2.985	28.3	0.105	48.2	0.264	-139.8	1.135	12.32
2.8	0.585	130.4	2.862	25.6	0.108	47.4	0.269	-143.2	1.128	12.05
2.9	0.596	129.1	2.764	22.9	0.112	46.3	0.280	-147.0	1.107	11.94
3.0	0.598	127.3	2.685	20.6	0.115	45.4	0.283	-150.9	1.109	11.67



PACKAGE DIMENSIONS

4-PIN SUPER MINIMOLD (UNIT: mm)

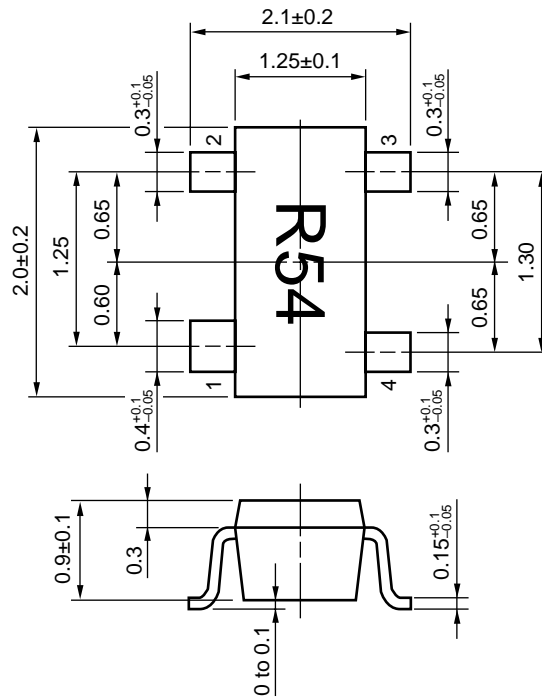

PIN CONNECTIONS

- 1. Collector
- 2. Emitter
- 3. Base
- 4. Emitter

- **The information in this document is current as of July, 2001. The information is subject to change without notice. For actual design-in, refer to the latest publications of NEC's data sheets or data books, etc., for the most up-to-date specifications of NEC semiconductor products. Not all products and/or types are available in every country. Please check with an NEC sales representative for availability and additional information.**
  - No part of this document may be copied or reproduced in any form or by any means without prior written consent of NEC. NEC assumes no responsibility for any errors that may appear in this document.
  - NEC does not assume any liability for infringement of patents, copyrights or other intellectual property rights of third parties by or arising from the use of NEC semiconductor products listed in this document or any other liability arising from the use of such products. No license, express, implied or otherwise, is granted under any patents, copyrights or other intellectual property rights of NEC or others.
  - Descriptions of circuits, software and other related information in this document are provided for illustrative purposes in semiconductor product operation and application examples. The incorporation of these circuits, software and information in the design of customer's equipment shall be done under the full responsibility of customer. NEC assumes no responsibility for any losses incurred by customers or third parties arising from the use of these circuits, software and information.
  - While NEC endeavours to enhance the quality, reliability and safety of NEC semiconductor products, customers agree and acknowledge that the possibility of defects thereof cannot be eliminated entirely. To minimize risks of damage to property or injury (including death) to persons arising from defects in NEC semiconductor products, customers must incorporate sufficient safety measures in their design, such as redundancy, fire-containment, and anti-failure features.
  - NEC semiconductor products are classified into the following three quality grades:  
 "Standard", "Special" and "Specific". The "Specific" quality grade applies only to semiconductor products developed based on a customer-designated "quality assurance program" for a specific application. The recommended applications of a semiconductor product depend on its quality grade, as indicated below. Customers must check the quality grade of each semiconductor product before using it in a particular application.  
 "Standard": Computers, office equipment, communications equipment, test and measurement equipment, audio and visual equipment, home electronic appliances, machine tools, personal electronic equipment and industrial robots  
 "Special": Transportation equipment (automobiles, trains, ships, etc.), traffic control systems, anti-disaster systems, anti-crime systems, safety equipment and medical equipment (not specifically designed for life support)  
 "Specific": Aircraft, aerospace equipment, submersible repeaters, nuclear reactor control systems, life support systems and medical equipment for life support, etc.
- The quality grade of NEC semiconductor products is "Standard" unless otherwise expressly specified in NEC's data sheets or data books, etc. If customers wish to use NEC semiconductor products in applications not intended by NEC, they must contact an NEC sales representative in advance to determine NEC's willingness to support a given application.
- (Note)
- (1) "NEC" as used in this statement means NEC Corporation and also includes its majority-owned subsidiaries.
  - (2) "NEC semiconductor products" means any semiconductor product developed or manufactured by or for NEC (as defined above).