

RJH60D3DPP-M0

600V - 17A - 绝缘栅双极晶体管

应用: 逆变器

R07DS0162CJ0400

修订版本 4.00

Jul 25, 2012

特点

- 短路承受时间 (5 μ s 典型值)
- 低集电极/发射极饱和电压
 $V_{CE(sat)} = 1.6$ V 典型值 ($I_C = 17$ A, $V_{GE} = 15$ V, $T_a = 25^\circ\text{C}$)
- 内置快速恢复二极管 (100 ns 典型值) 于一封装
- 沟槽栅与薄晶圆技术
- 快速开关时间
 $t_f = 70$ ns 典型值 ($V_{CC} = 300$ V, $V_{GE} = 15$ V, $I_C = 17$ A, $R_g = 5 \Omega$, $T_a = 25^\circ\text{C}$)

封装形式

RENESAS 封装代码: PRSS0003AF-A
 (封装名称: TO-220FL)

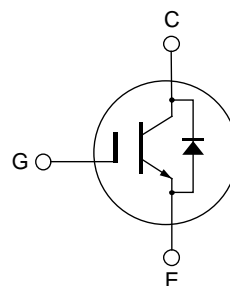
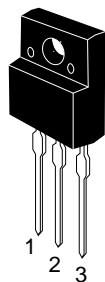

1. 栅极
2. 集电极
3. 发射极

绝对最大额定值

($T_a = 25^\circ\text{C}$)

参数	符号	额定值	单位
集电极/发射极电压 或 二极管反向电压	V_{CES} / V_R	600	V
栅极/发射极电压	V_{GES}	± 30	V
集电极电流	$T_c = 25^\circ\text{C}$	I_C	35 A
	$T_c = 100^\circ\text{C}$	I_C	17 A
集电极脉冲电流	$i_{c(peak)}$ ^{注1}	70	A
集电极/发射极二极管正向电流	i_{DF}	17	A
集电极/发射极二极管正向脉冲电流	$i_{DF(peak)}$ ^{注1}	70	A
集电极最大容许功率损耗	P_C ^{注2}	40	W
结壳热阻 (绝缘栅双极晶体管)	θ_{j-c} ^{注2}	3.15	$^\circ\text{C}/\text{W}$
结壳热阻 (二极管)	θ_{j-cd} ^{注2}	4.9	$^\circ\text{C}/\text{W}$
结温	T_j	150	$^\circ\text{C}$
储存温度	T_{stg}	-55 to +150	$^\circ\text{C}$

- 注: 1. 在 $PW \leq 10 \mu\text{s}$, 工作周期 $\leq 1\%$ 的容许值
 2. 在 $T_c = 25^\circ\text{C}$ 的容许值

电特性

(Ta = 25°C)

参数	符号	最小值	典型值	最大值	单位	测定条件
集电极/发射极破坏电压	$V_{BR(CES)}$	600	—	—	V	$I_C = 10 \mu A, V_{GE} = 0$
集电极/发射极断路电流 或 二极管反向电流	I_{CES} / I_R	—	—	5	μA	$V_{CE} = 600 V, V_{GE} = 0$
栅极/发射极漏泄电流	I_{GES}	—	—	± 1	μA	$V_{GE} = \pm 30 V, V_{CE} = 0$
栅极/发射极截止电压	$V_{GE(off)}$	4.0	—	6.0	V	$V_{CE} = 10 V, I_C = 1 mA$
集电极/发射极饱和电压	$V_{CE(sat)}$	—	1.6	2.2	V	$I_C = 17 A, V_{GE} = 15 V$ ^{注3}
	$V_{CE(sat)}$	—	2.0	—	V	$I_C = 35 A, V_{GE} = 15 V$ ^{注3}
输入电容	C_{ies}	—	900	—	pF	$V_{CE} = 25 V$
输出电容	C_{oes}	—	60	—	pF	$V_{GE} = 0$
反向传输电容	C_{res}	—	25	—	pF	$f = 1 MHz$
栅极充电电荷量	Q_g	—	37	—	nC	$V_{GE} = 15 V$
栅极/发射极充电电荷量	Q_{ge}	—	6.5	—	nC	$V_{CE} = 300 V$
栅极/集电极充电电荷量	Q_{gc}	—	15	—	nC	$I_C = 17 A$
接通延迟时间	$t_{d(on)}$	—	35	—	ns	$V_{CC} = 300 V$
上升时间	t_r	—	16	—	ns	$V_{GE} = 15 V$
关断延迟时间	$t_{d(off)}$	—	80	—	ns	$I_C = 17 A$
下降时间	t_f	—	70	—	ns	$R_g = 5 \Omega$ 感性负载
接通能量	E_{on}	—	0.20	—	mJ	
关断能量	E_{off}	—	0.21	—	mJ	
总开关能量	E_{total}	—	0.41	—	mJ	
短路承受时间	t_{sc}	3.0	5.0	—	μs	$V_{CC} \leq 360 V, V_{GE} = 15 V$
快速恢复二极管正向电压	V_F	—	1.3	1.7	V	$I_F = 17 A$ ^{注3}
快速恢复二极管反向恢复时间	t_{rr}	—	100	—	ns	$I_F = 17 A$
快速恢复二极管反向恢复电荷	Q_{rr}	—	0.15	—	μC	$di_F/dt = 100 A/\mu s$
快速恢复二极管反向恢复电流	I_{rr}	—	4.2	—	A	

注: 3. 脉冲测试

主要特性

集电极功率损耗-壳温

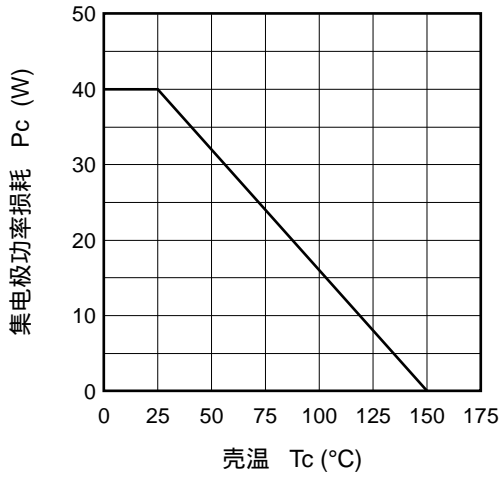

集电极最大直流电流-壳温

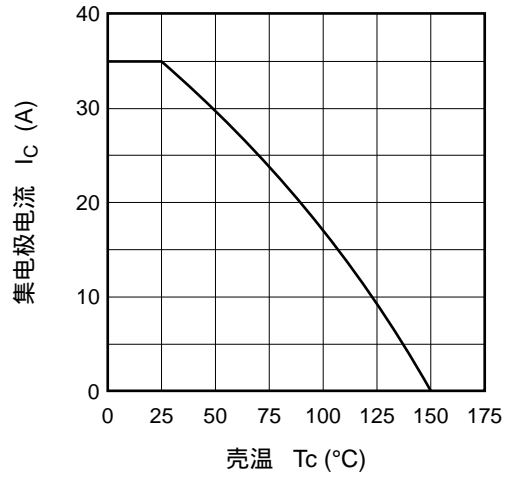

最大安全工作区域

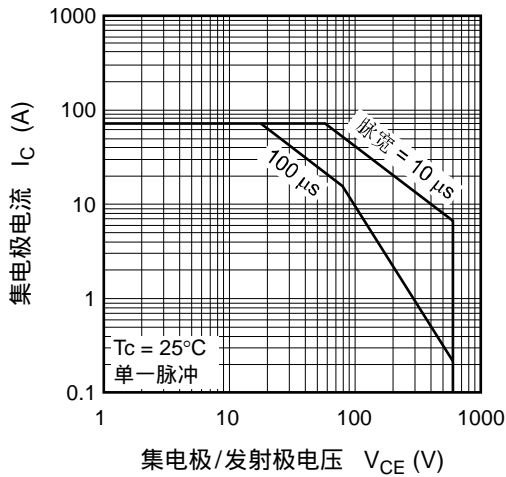

关断安全工作区域

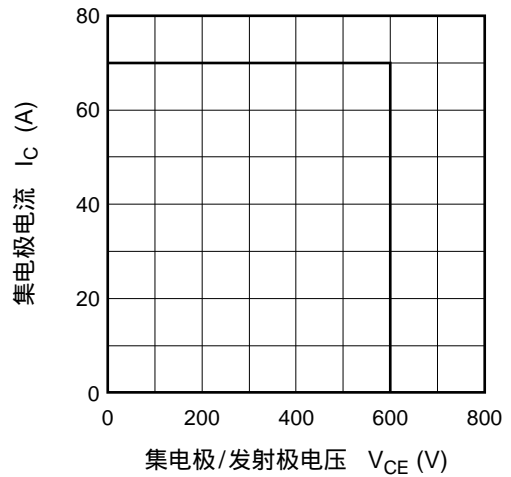

典型输出特性

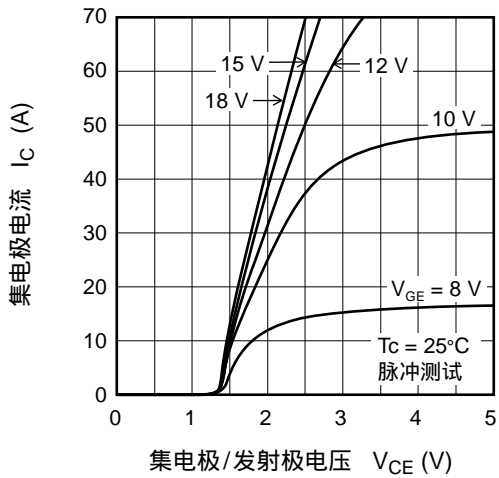

典型输出特性

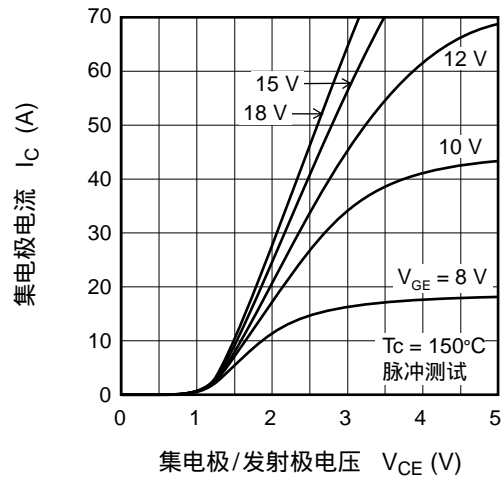

集电极/发射极饱和电压-栅极/发射极电压 (典型)

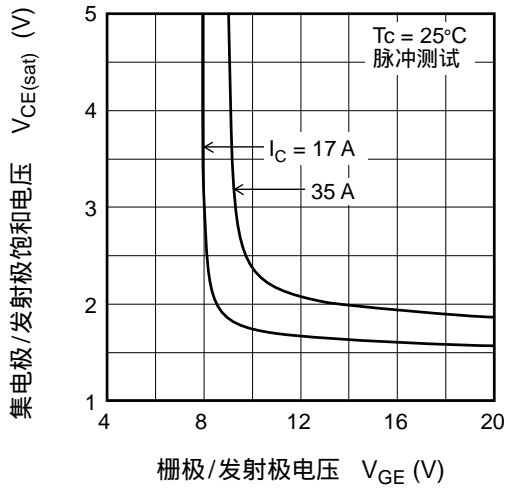

集电极/发射极饱和电压-栅极/发射极电压 (典型)

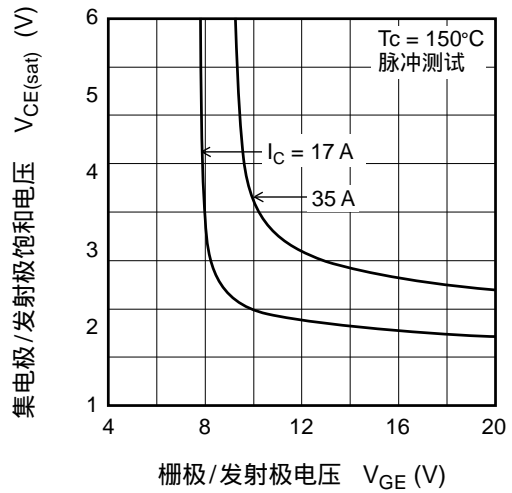

典型传输特性

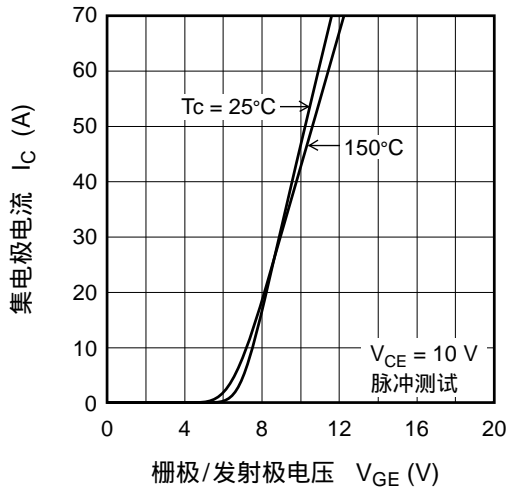

集电极/发射极饱和电压-壳温 (典型)

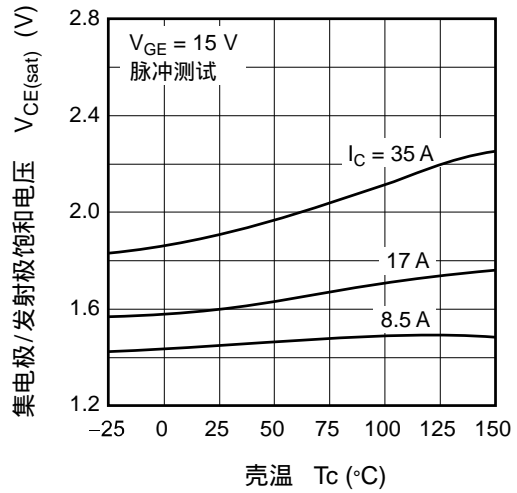

栅极/发射极截止电压-壳温 (典型)

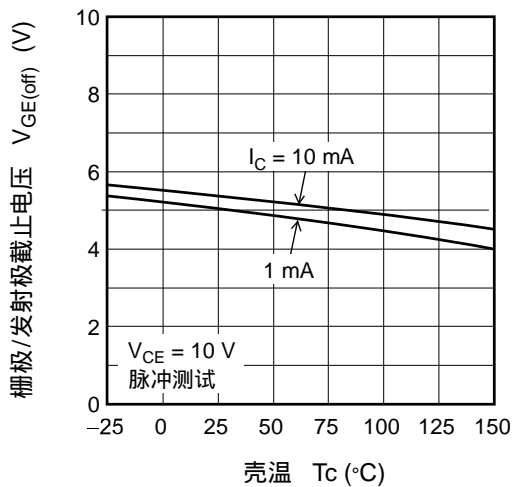

频率特性 (典型)

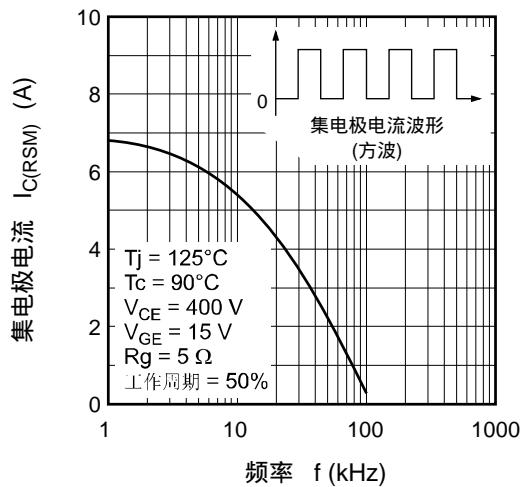

开关特性 (典型) (1)

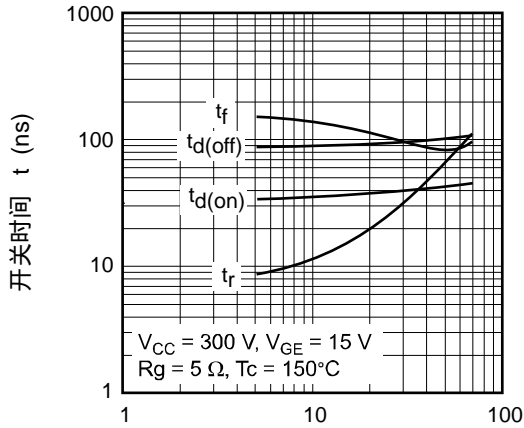

集电极电流 I_C (A)
(感性负载)

开关特性 (典型) (2)

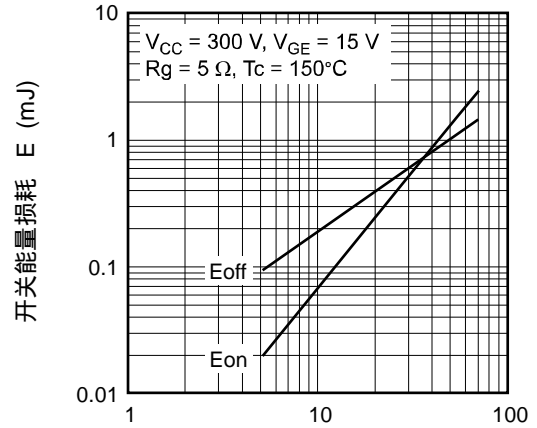

集电极电流 I_C (A)
(感性负载)

开关特性 (典型) (3)

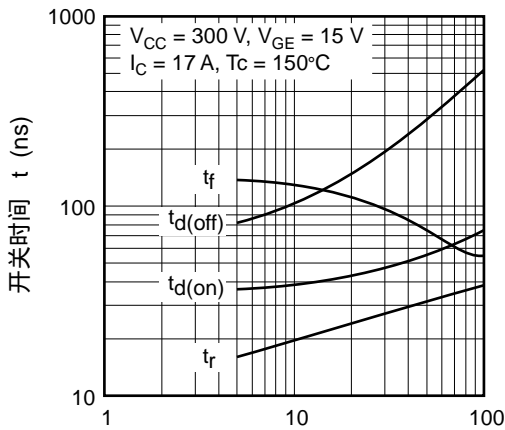

栅极电阻 R_g (Ω)
(感性负载)

开关特性 (典型) (4)

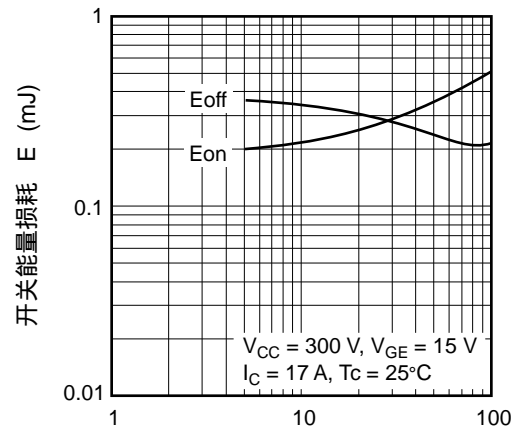

栅极电阻 R_g (Ω)
(感性负载)

开关特性 (典型) (5)

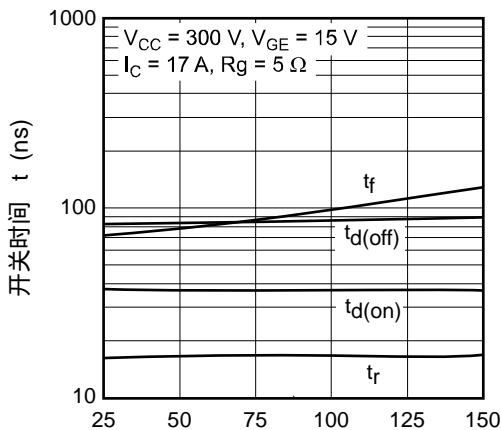

壳温 T_c ($^\circ\text{C}$)
(感性负载)

开关特性 (典型) (6)

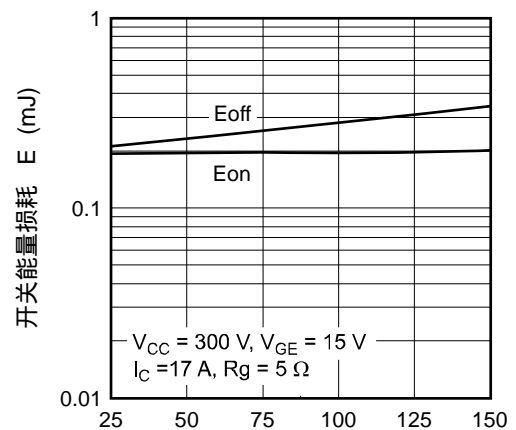

壳温 T_c ($^\circ\text{C}$)
(感性负载)

典型电容-集电极/发射极电压

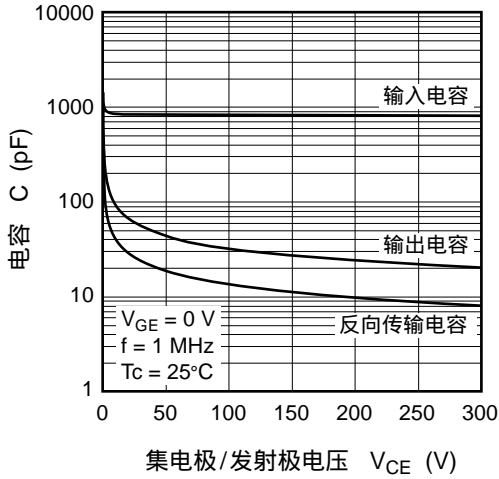

输入时序特性 (典型)

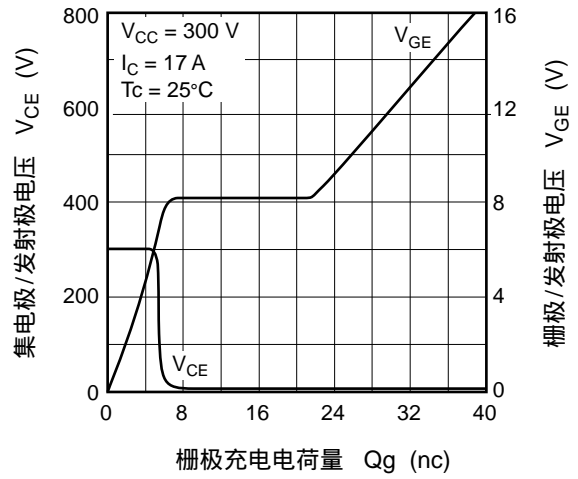

反向恢复时间-二极管电流斜率 (典型)

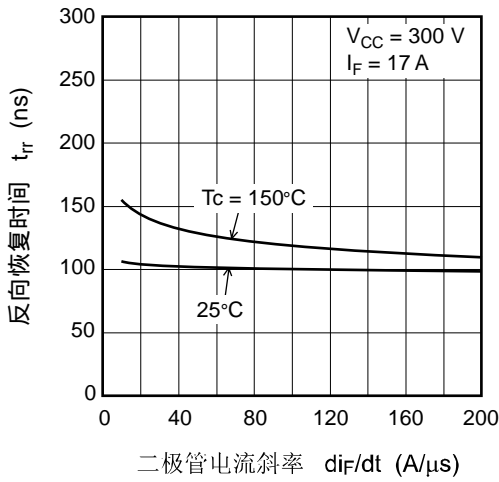

反向恢复电荷-二极管电流斜率 (典型)

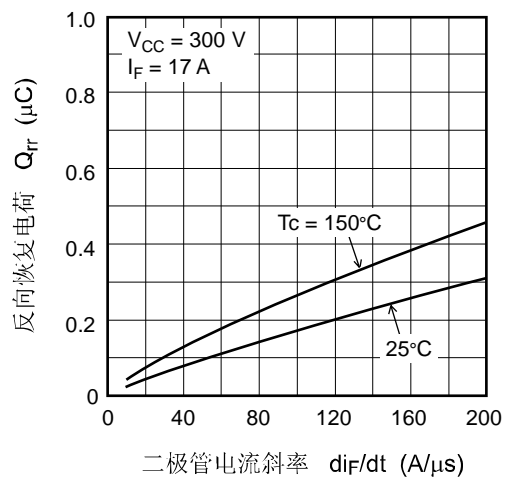

反向恢复电流-二极管电流斜率 (典型)

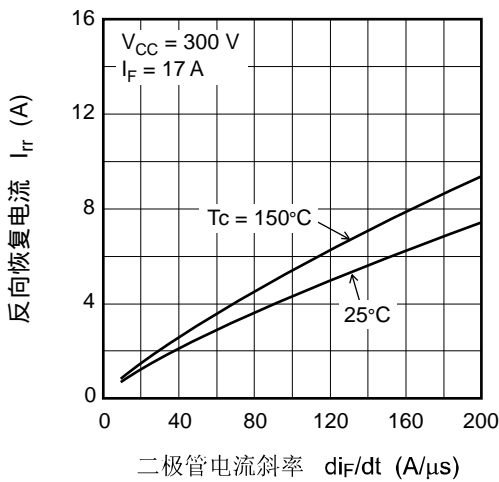

正向电流-正向电压 (典型)

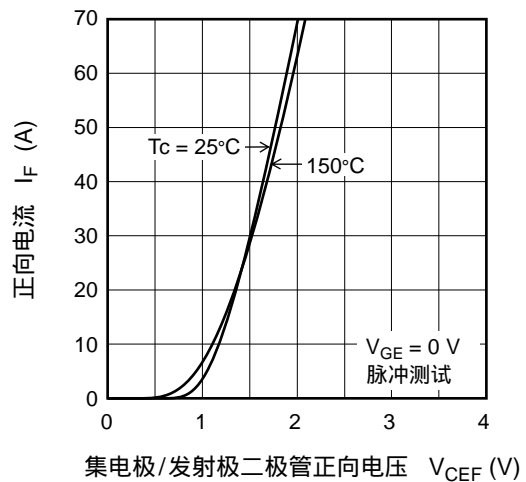

瞬态热阻特性规格化 (绝缘栅双极晶体管)

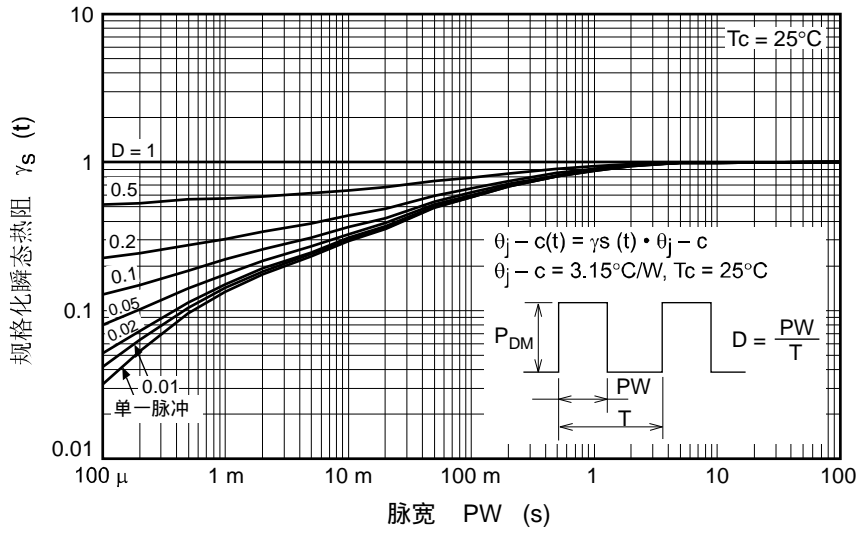

瞬态热阻特性规格化 (二极管)

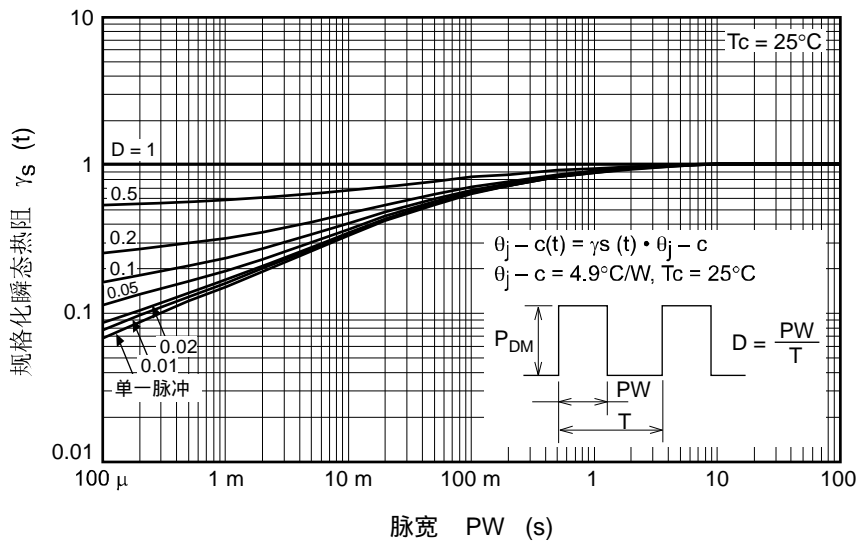

开关时间测定电路

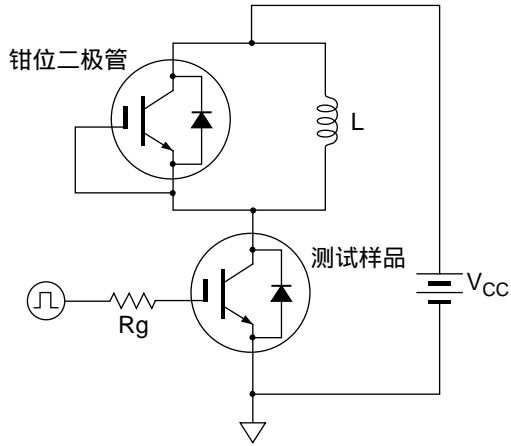

波形

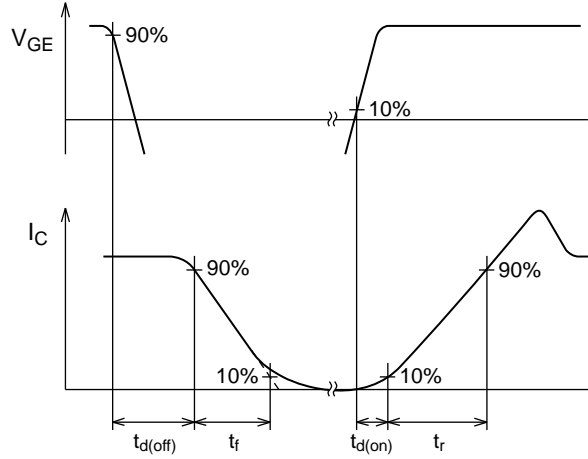

二极管反向恢复时间测定电路

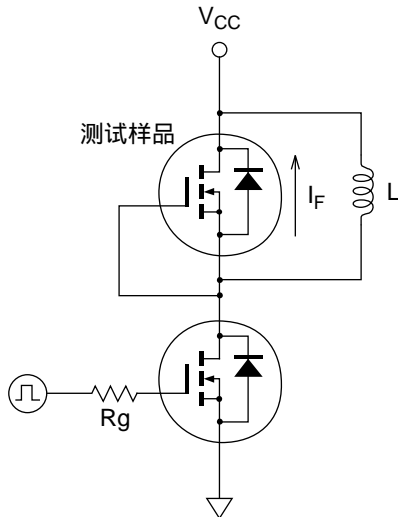

波形

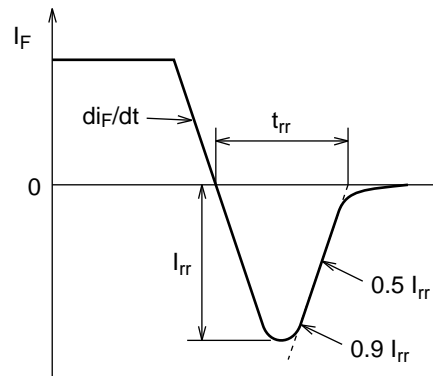

封装尺寸

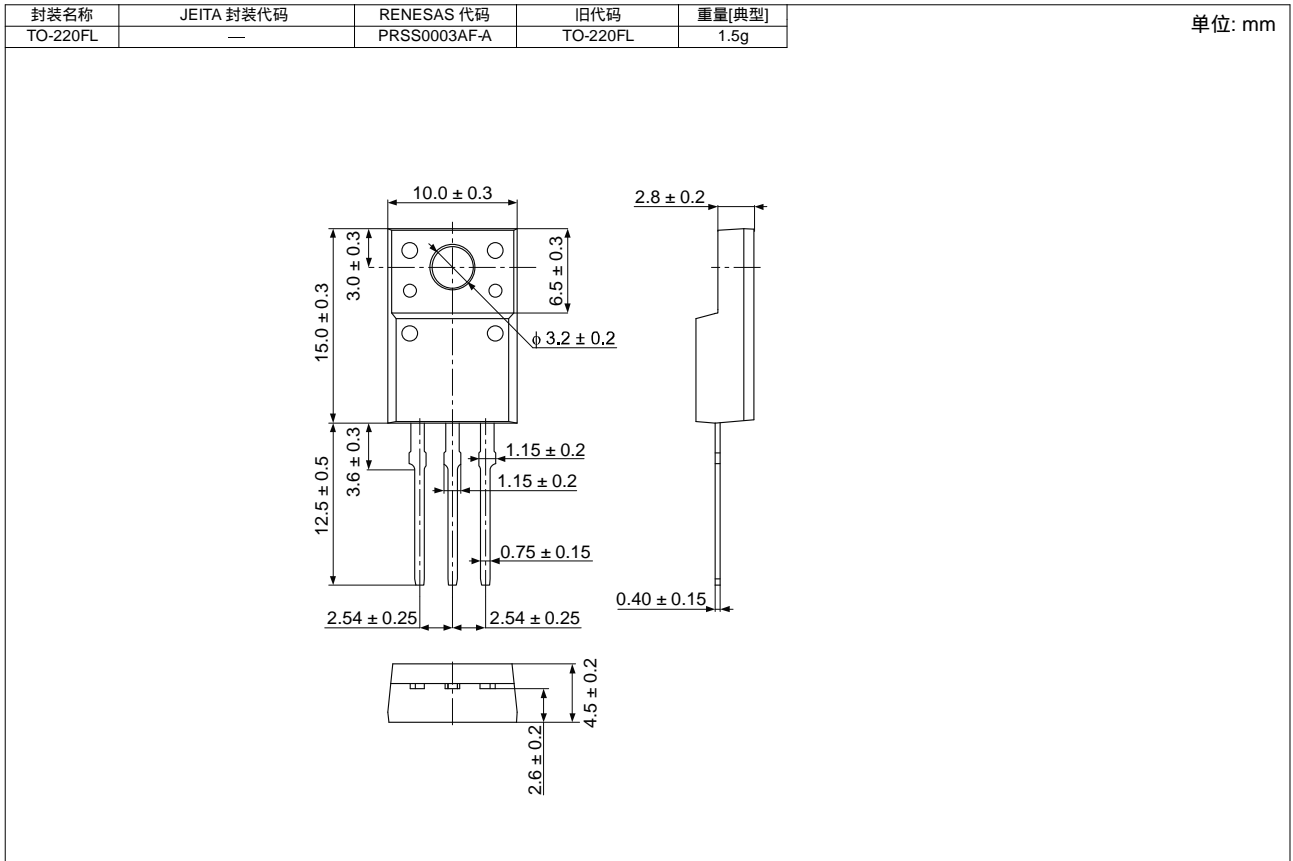

订购信息

订购型号	数量	运输包装
RJH60D3DPP-M0#T2	600 枚	纸盒包装 (管状容器)

Notice

1. Descriptions of circuits, software and other related information in this document are provided only to illustrate the operation of semiconductor products and application examples. You are fully responsible for the incorporation of these circuits, software, and information in the design of your equipment. Renesas Electronics assumes no responsibility for any losses incurred by you or third parties arising from the use of these circuits, software, or information.
 2. Renesas Electronics has used reasonable care in preparing the information included in this document, but Renesas Electronics does not warrant that such information is error free. Renesas Electronics assumes no liability whatsoever for any damages incurred by you resulting from errors in or omissions from the information included herein.
 3. Renesas Electronics does not assume any liability for infringement of patents, copyrights, or other intellectual property rights of third parties by or arising from the use of Renesas Electronics products or technical information described in this document. No license, express, implied or otherwise, is granted hereby under any patents, copyrights or other intellectual property rights of Renesas Electronics or others.
 4. You should not alter, modify, copy, or otherwise misappropriate any Renesas Electronics product, whether in whole or in part. Renesas Electronics assumes no responsibility for any losses incurred by you or third parties arising from such alteration, modification, copy or otherwise misappropriation of Renesas Electronics product.
 5. Renesas Electronics products are classified according to the following two quality grades: "Standard" and "High Quality". The recommended applications for each Renesas Electronics product depends on the product's quality grade, as indicated below.
"Standard": Computers; office equipment; communications equipment; test and measurement equipment; audio and visual equipment; home electronic appliances; machine tools; personal electronic equipment; and industrial robots etc.
"High Quality": Transportation equipment (automobiles, trains, ships, etc.); traffic control systems; anti-disaster systems; anti-crime systems; and safety equipment etc.
Renesas Electronics products are neither intended nor authorized for use in products or systems that may pose a direct threat to human life or bodily injury (artificial life support devices or systems, surgical implantations etc.), or may cause serious property damages (nuclear reactor control systems, military equipment etc.). You must check the quality grade of each Renesas Electronics product before using it in a particular application. You may not use any Renesas Electronics product for any application for which it is not intended. Renesas Electronics shall not be in any way liable for any damages or losses incurred by you or third parties arising from the use of any Renesas Electronics product for which the product is not intended by Renesas Electronics.
 6. You should use the Renesas Electronics products described in this document within the range specified by Renesas Electronics, especially with respect to the maximum rating, operating supply voltage range, movement power voltage range, heat radiation characteristics, installation and other product characteristics. Renesas Electronics shall have no liability for malfunctions or damages arising out of the use of Renesas Electronics products beyond such specified ranges.
 7. Although Renesas Electronics endeavors to improve the quality and reliability of its products, semiconductor products have specific characteristics such as the occurrence of failure at a certain rate and malfunctions under certain use conditions. Further, Renesas Electronics products are not subject to radiation resistance design. Please be sure to implement safety measures to guard them against the possibility of physical injury, and injury or damage caused by fire in the event of the failure of a Renesas Electronics product, such as safety design for hardware and software including but not limited to redundancy, fire control and malfunction prevention, appropriate treatment for aging degradation or any other appropriate measures. Because the evaluation of microcomputer software alone is very difficult, please evaluate the safety of the final products or systems manufactured by you.
 8. Please contact a Renesas Electronics sales office for details as to environmental matters such as the environmental compatibility of each Renesas Electronics product. Please use Renesas Electronics products in compliance with all applicable laws and regulations that regulate the inclusion or use of controlled substances, including without limitation, the EU RoHS Directive. Renesas Electronics assumes no liability for damages or losses occurring as a result of your noncompliance with applicable laws and regulations.
 9. Renesas Electronics products and technology may not be used for or incorporated into any products or systems whose manufacture, use, or sale is prohibited under any applicable domestic or foreign laws or regulations. You should not use Renesas Electronics products or technology described in this document for any purpose relating to military applications or use by the military, including but not limited to the development of weapons of mass destruction. When exporting the Renesas Electronics products or technology described in this document, you should comply with the applicable export control laws and regulations and follow the procedures required by such laws and regulations.
 10. It is the responsibility of the buyer or distributor of Renesas Electronics products, who distributes, disposes of, or otherwise places the product with a third party, to notify such third party in advance of the contents and conditions set forth in this document, Renesas Electronics assumes no responsibility for any losses incurred by you or third parties as a result of unauthorized use of Renesas Electronics products.
 11. This document may not be reproduced or duplicated in any form, in whole or in part, without prior written consent of Renesas Electronics.
 12. Please contact a Renesas Electronics sales office if you have any questions regarding the information contained in this document or Renesas Electronics products, or if you have any other inquiries.
- (Note 1) "Renesas Electronics" as used in this document means Renesas Electronics Corporation and also includes its majority-owned subsidiaries.
(Note 2) "Renesas Electronics product(s)" means any product developed or manufactured by or for Renesas Electronics.



SALES OFFICES

Renesas Electronics Corporation

<http://www.renesas.com>

Refer to "<http://www.renesas.com/>" for the latest and detailed information.

Renesas Electronics America Inc.
2880 Scott Boulevard Santa Clara, CA 95050-2554, U.S.A.
Tel: +1-408-588-6000, Fax: +1-408-588-6130

Renesas Electronics Canada Limited
1101 Nicholson Road, Newmarket, Ontario L3Y 9C3, Canada
Tel: +1-905-898-5441, Fax: +1-905-898-3220

Renesas Electronics Europe Limited
Dukes Meadow, Millboard Road, Bourne End, Buckinghamshire, SL8 5FH, U.K.
Tel: +44-1628-585-100, Fax: +44-1628-585-900

Renesas Electronics Europe GmbH
Arcadiastrasse 10, 40472 Düsseldorf, Germany
Tel: +49-211-65030, Fax: +49-211-6503-1327

Renesas Electronics (China) Co., Ltd.
7th Floor, Quantum Plaza, No.27 ZhiChunLu Haidian District, Beijing 100083, P.R.China
Tel: +86-10-8235-1155, Fax: +86-10-8235-7679

Renesas Electronics (Shanghai) Co., Ltd.
Unit 204, 205, AZIA Center, No.1233 Lujiazui Ring Rd., Pudong District, Shanghai 200120, China
Tel: +86-21-5877-1818, Fax: +86-21-6887-7858 / -7898

Renesas Electronics Hong Kong Limited
Unit 1601-1613, 16/F., Tower 2, Grand Century Place, 193 Prince Edward Road West, Mongkok, Kowloon, Hong Kong
Tel: +852-2886-9318, Fax: +852 2886-9022/9044

Renesas Electronics Taiwan Co., Ltd.
13F, No. 363, Fu Shing North Road, Taipei, Taiwan
Tel: +886-2-8175-9600, Fax: +886 2-8175-9670

Renesas Electronics Singapore Pte. Ltd.
1 HarbourFront Avenue, #06-10, Keppel Bay Tower, Singapore 098632
Tel: +65-6213-0200, Fax: +65-6278-8001

Renesas Electronics Malaysia Sdn.Bhd.
Unit 906, Block B, Menara Amcorp, Amcorp Trade Centre, No. 18, Jln Persiaran Barat, 46050 Petaling Jaya, Selangor Darul Ehsan, Malaysia
Tel: +60-3-7955-3390, Fax: +60-3-7955-9510

Renesas Electronics Korea Co., Ltd.
11F., Samik Laved or Bldg., 720-2 Yeoksam-Dong, Kangnam-Ku, Seoul 135-080, Korea
Tel: +82-2-558-3737, Fax: +82-2-558-5141