

TP65H035G4QS

650V SuperGaN® FET in TOLL (source tab)

Description

The TP65H035G4QS 650V, 35 mΩ gallium nitride (GaN) FET is a normally-off device using Renesas's Gen IV platform. It combines a state-of-the-art high voltage GaN HEMT with a low voltage silicon MOSFET to offer superior reliability and performance.

The Gen IV SuperGaN® platform uses advanced epi and patented design technologies to simplify manufacturability while improving efficiency over silicon via lower gate charge, output capacitance, crossover loss, and reverse recovery charge.

Related Literature

- [Recommended External Circuitry for GaN FETs](#)
- [Printed Circuit Board Layout and Probing](#)
- [Low cost driver solution](#)

Ordering Information

Part Number	Package	Package Configuration
TP65H035G4QS-TR	10x12mm TOLL	Source

* "-TR" suffix refers to tape and reel. Refer to AN0012 for details.

TP65H035G4QS
TOLL
(bottom view)

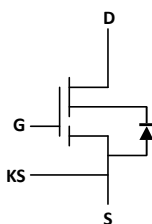
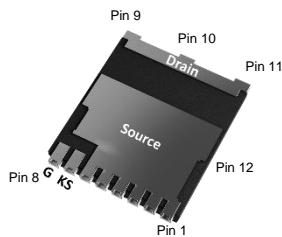

Cascode Schematic Symbol

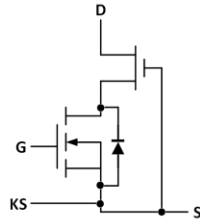

Cascode Device Structure

Features

- JEDEC qualified GaN technology
- Dynamic $R_{DS(on)eff}$ production tested
- Robust design, defined by
 - Wide gate safety margin
 - Transient over-voltage capability
- Enhanced inrush current capability
- Very low Q_{RR}
- Reduced crossover loss
- Kelvin source for low inductance gate return path

Benefits

- Enables AC-DC bridgeless totem-pole PFC designs
 - Increased power density
 - Reduced system size and weight
 - Overall lower system cost
- Achieves increased efficiency in both hard- and soft-switched circuits
- Easy to drive with commonly-used gate drivers
- GSD pin layout improves high speed design
- Pin-to-pin drop-in with e-mode GaN

Applications

- Datacom
- Broad industrial
- PV inverter
- Servo motor



Key Specifications

V_{DSS} (V)	650
$V_{(TR)DSS}$ (V)	800
$R_{DS(on)eff}$ (mΩ) max*	41
Q_{RR} (nC) typ	150
Q_G (nC) typ	22

* Dynamic on-resistance; ; see Figures 20 and 21

Absolute Maximum Ratings ($T_c=25\text{ }^\circ\text{C}$ unless otherwise stated.)

Symbol	Parameter	Limit Value	Unit	
V_{DSS}	Drain to source voltage ($T_J = -55\text{ }^\circ\text{C}$ to $150\text{ }^\circ\text{C}$)	650	V	
$V_{(TR)DSS}$	Transient drain to source voltage ^(a)	800		
V_{GSS}	Gate to source voltage	± 20		
P_D	Maximum power dissipation @ $T_c=25\text{ }^\circ\text{C}$	156	W	
I_D	Continuous drain current @ $T_c=25\text{ }^\circ\text{C}$ ^(b)	46.5	A	
	Continuous drain current @ $T_c=100\text{ }^\circ\text{C}$ ^(b)	29.5	A	
I_{DM}	Pulsed drain current (pulse width: $10\mu\text{s}$)	240	A	
T_c	Operating temperature	Case	-55 to $+150$	$^\circ\text{C}$
T_J		Junction	-55 to $+150$	$^\circ\text{C}$
T_s	Storage temperature	-55 to $+150$	$^\circ\text{C}$	
T_{SOLD}	Reflow soldering temperature ^(c)	260	$^\circ\text{C}$	

Notes:

- a. In off-state, spike duty cycle $D < 0.01$, spike duration $< 30\mu\text{s}$, none repetitive
- b. For increased stability at high current operation, see Circuit Implementation on page 3
- c. Reflow MSL3

Thermal Resistance

Symbol	Parameter	Typical	Unit
$R_{\theta JC}$	Junction-to-case	0.8	$^\circ\text{C/W}$
$R_{\theta JA}$	Junction-to-ambient	45	$^\circ\text{C/W}$

Circuit Implementation

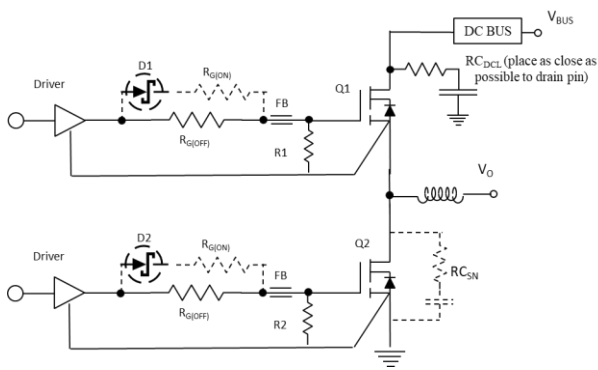

For additional gate driver options/configurations, please see Application Note [Recommended External Circuitry for GaN FETs](#)

Layout Recommendations for hard switching Gate Loop:

- Gate Driver: SiLab Si823x/Si827x
- Keep gate loop compact (using Kelvin source)

Power loop: (For reference see page 12)

- Minimize power loop path inductance
- Minimize switching node coupling with high and low power plane
- Add DC bus noise filter (RC_{DCL}) to reduce to voltage ringing
- Add Switching node snubber for high current operation

Simplified half-bridge hard switching schematic (See also on Figure 16)

Parameter	Symbol	Value
Single Gate Resistor	R_G ($R_{G(OFF)}$ only)	30 Ω (D1/D2/ $R_{G(ON)}$: NS)
Dual Gate Resistor	$R_{G(ON)} / R_{G(OFF)}$	15 Ω / 30 Ω
Dual Gate Resistor	Effective $R_{G(ON)} / R_{G(OFF)}$	10 Ω / 30 Ω
Operating frequency	F_{sw}	60~100 kHz
Steering Diode	D1/D2	Schottky diode ($V_r \geq 20V, V_f \leq 0.5V, I_o \geq 1A$)
Gate Ferrite Bead	FB	180 – 270 Ω at 100MHz ^(d)
Gate-to-source Resistor	R1/R2	10 k Ω
DC Link RC Noise Filter	RC_{DCL}	[4.7nF + 5 Ω] x 2 or [10nF+ 2.3 Ω]
Switching Node RC Snubber	RC_{SN}	Not Necessary ^(e)
Gate Driver	Driver	Si823x/Si827x or similar

Note:

d. For every design and layout, a range of ferrite beads (FB), R_G and DC link RC filter should be evaluated to help suppress any high frequency ringing and optimize performance

e. RC_{SN} (100pF + 10 Ω) is needed if

- R_s is smaller than recommendations
- Layout is not optimized
- Requires high current operation

Electrical Parameters ($T_J=25^\circ\text{C}$ unless otherwise stated)

Symbol	Parameter	Min	Typ	Max	Unit	Test Conditions
Forward Device Characteristics						
$V_{DS(BL)}$	Drain-source voltage	650	—	—	V	$V_{GS}=0V$
$V_{GS(th)}$	Gate threshold voltage	3.3	4	4.8	V	$V_{DS}=V_{GS}, I_D=1mA$
$\Delta V_{GS(th)}/T_J$	Gate threshold voltage temperature coefficient	—	-6.5	—	mV/ $^\circ\text{C}$	
$R_{DS(on)eff}$	Drain-source on-resistance ^(f)	—	35	41	m Ω	$V_{GS}=10V, I_D=30A$
		—	72	—		$V_{GS}=10V, I_D=30A, T_J=150^\circ\text{C}$
I_{DSS}	Drain-to-source leakage current	—	3	30	μA	$V_{DS}=650V, V_{GS}=0V$
		—	20	—		$V_{DS}=650V, V_{GS}=0V, T_J=150^\circ\text{C}$
I_{GSS}	Gate-to-source forward leakage current	—	—	400	nA	$V_{GS}=20V$
	Gate-to-source reverse leakage current	—	—	-400		$V_{GS}=-20V$
C_{ISS}	Input capacitance	—	1500	—	pF	$V_{GS}=0V, V_{DS}=400V, f=1MHz$
C_{OSS}	Output capacitance	—	147	—		
C_{RSS}	Reverse transfer capacitance	—	5	—		
$C_{O(er)}$	Output capacitance, energy related ^(g)	—	220	—	pF	$V_{GS}=0V, V_{DS}=0V$ to 400V
$C_{O(tr)}$	Output capacitance, time related ^(h)	—	380	—		
Q_G	Total gate charge	—	22	—	nC	$V_{DS}=400V, V_{GS}=0V$ to 10V, $I_D=32A$
Q_{GS}	Gate-source charge	—	8.4	—		
Q_{GD}	Gate-drain charge	—	6.6	—		
Q_{OSS}	Output charge	—	150	—	nC	$V_{GS}=0V, V_{DS}=0V$ to 400V
$t_{D(on)}$	Turn-on delay	—	60	—	ns	$V_{DS}=400V, V_{GS}=0V$ to 12V, $R_G=30\Omega, I_D=32A, Z_{FB}=240\Omega$ at 100MHz (See Figure 15)
t_R	Rise time	—	10	—		
$t_{D(off)}$	Turn-off delay	—	94	—		
t_F	Fall time	—	10	—		
E_{off}	Turn off Energy	—	53	—	μJ	$V_{DS}=400V, V_{GS}=0V$ to 12V, $R_{G(on)}=10\Omega, R_{G(off)}=30\Omega, I_D=30A, Z_{FB}=180\Omega$ at 100MHz
E_{on}	Turn on Energy	—	66	—	μJ	

Notes:

- f. Dynamic on-resistance; see Figures 20 and 21 for test circuit and conditions
- g. Equivalent capacitance to give same stored energy as V_{DS} rises from 0V to 400V
- h. Equivalent capacitance to give same charging time as V_{DS} rises from 0V to 400V

Electrical Parameters ($T_J=25^\circ\text{C}$ unless otherwise stated)

Symbol	Parameter	Min	Typ	Max	Unit	Test Conditions
Reverse Device Characteristics						
I_S	Reverse current	—	—	29.5	A	$V_{GS}=0V$, $T_C=100^\circ\text{C}$ $\leq 25\%$ duty cycle
V_{SD}	Reverse voltage ⁽ⁱ⁾	—	1.8	—	V	$V_{GS}=0V$, $I_S=32A$
		—	1.3	—		$V_{GS}=0V$, $I_S=16A$
t_{RR}	Reverse recovery time	—	59	—	ns	$I_S=32A$, $V_{DD}=400V$, $di/dt=1000A/ms$
Q_{RR}	Reverse recovery charge ^(j)	—	0	—	nC	

Notes:

i. Includes dynamic $R_{DS(on)}$ effect

j. Excludes Q_{oss}

Typical Characteristics ($T_c=25^\circ\text{C}$ unless otherwise stated)

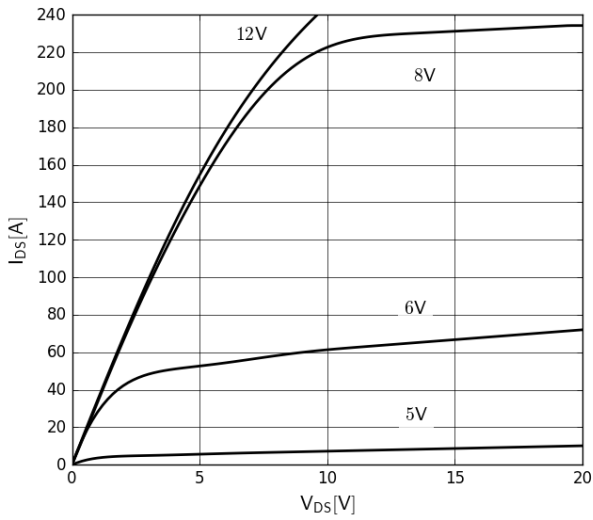

Figure 1. Typical Output Characteristics $T_J=25^\circ\text{C}$
Parameter: V_{GS}

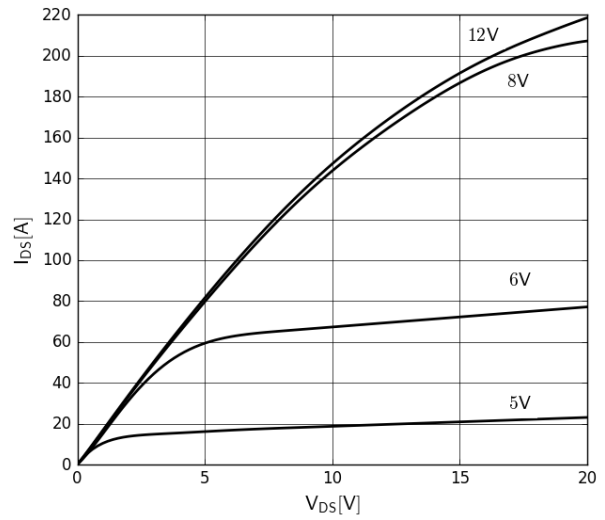

Figure 2. Typical Output Characteristics $T_J=150^\circ\text{C}$
Parameter: V_{GS}

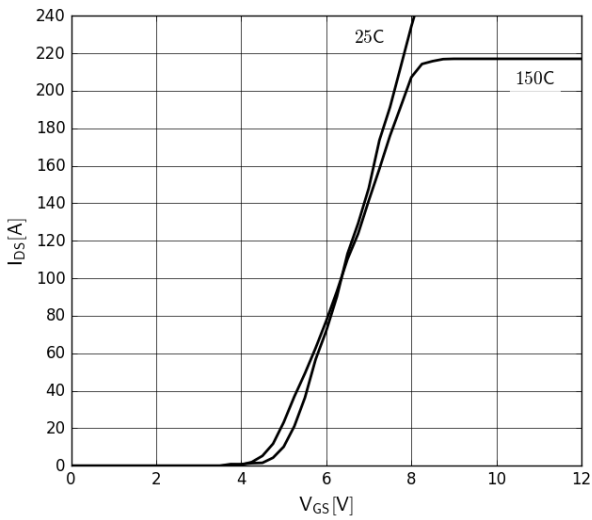

Figure 3. Typical Transfer Characteristics
 $V_{DS}=20\text{V}$, parameter: T_J

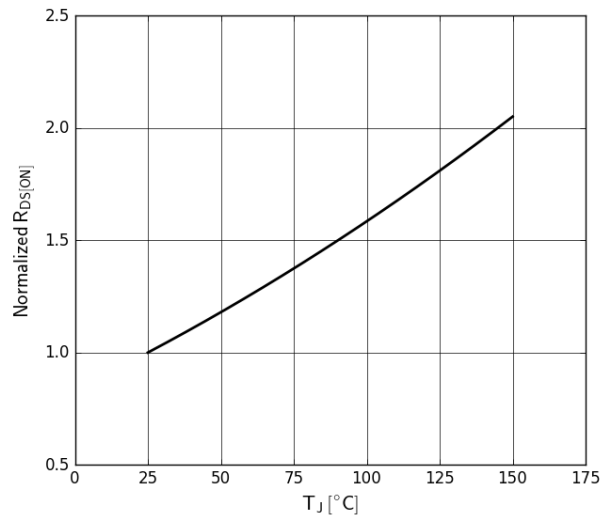

Figure 4. Normalized On-resistance
 $I_D=30\text{A}$, $V_{GS}=8\text{V}$

Typical Characteristics ($T_c=25^\circ\text{C}$ unless otherwise stated)

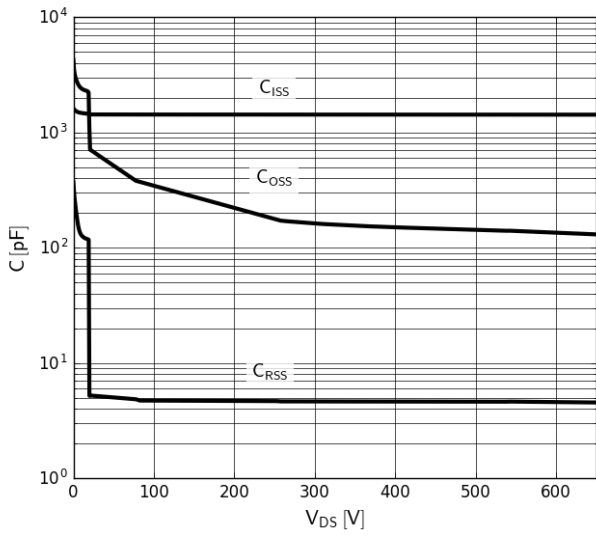

Figure 5. Typical Capacitance
 $V_{GS}=0V, f=1MHz$

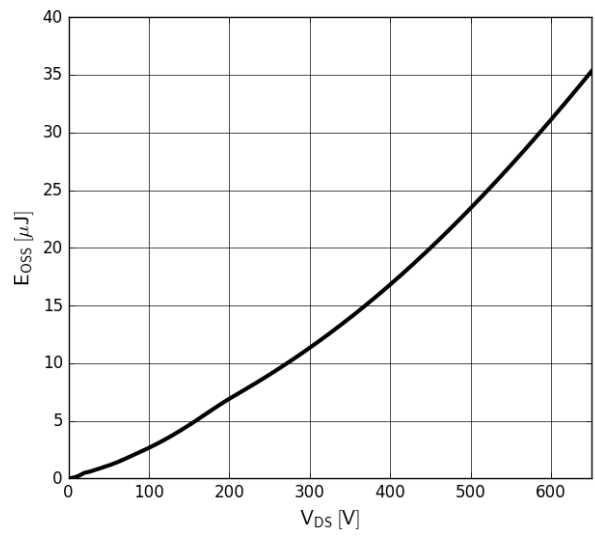

Figure 6. Typical C_{oss} Stored Energy

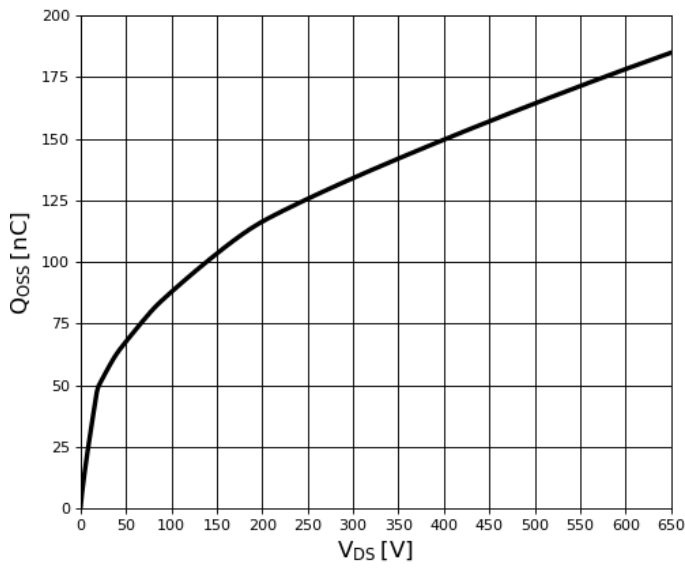

Figure 7. Typical Q_{oss}

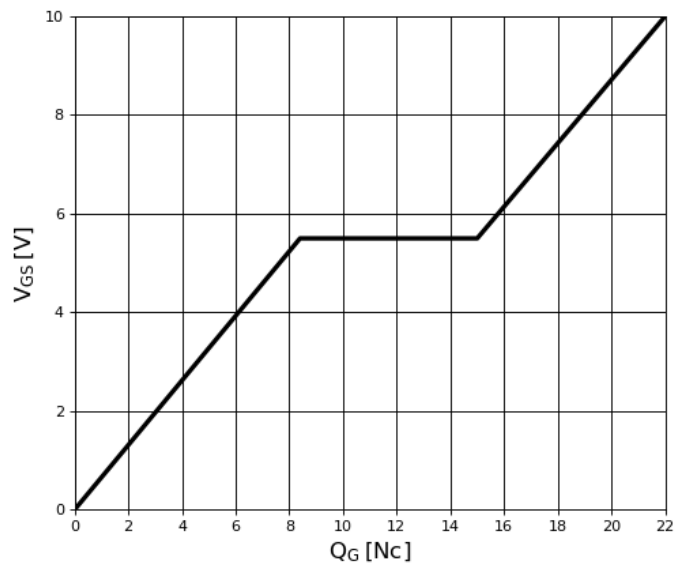

Figure 8. Typical Gate Charge
 $I_{DS}=32A, V_{DS}=400V$

Typical Characteristics ($T_c=25^\circ\text{C}$ unless otherwise stated)

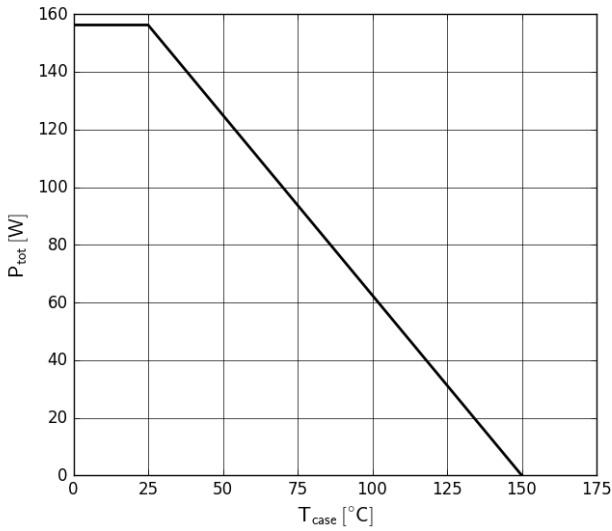

Figure 9. Power Dissipation

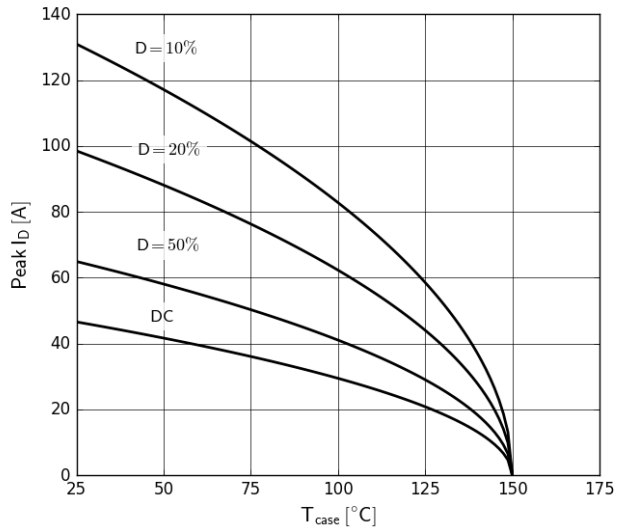

Figure 10. Current Derating

Pulse width $\leq 10\mu\text{s}$, $V_{\text{GS}} \geq 10\text{V}$

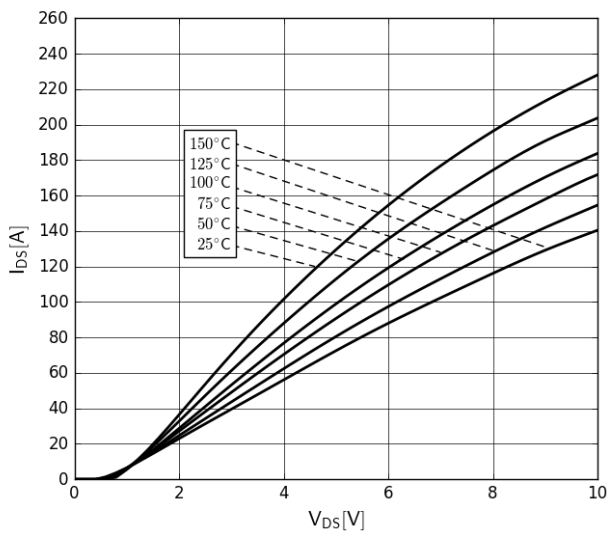

Figure 11. Forward Characteristics of Rev. Diode

$I_s=f(V_{\text{SD}})$, parameter: T_J

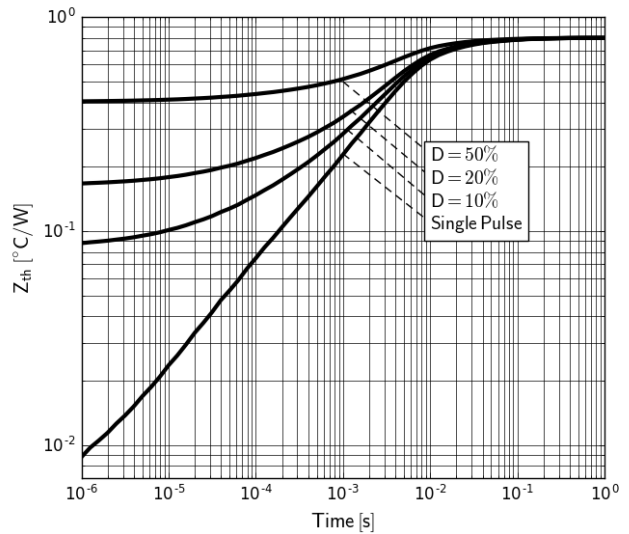

Figure 12. Transient Thermal Resistance

Typical Characteristics ($T_c=25^\circ\text{C}$ unless otherwise stated)

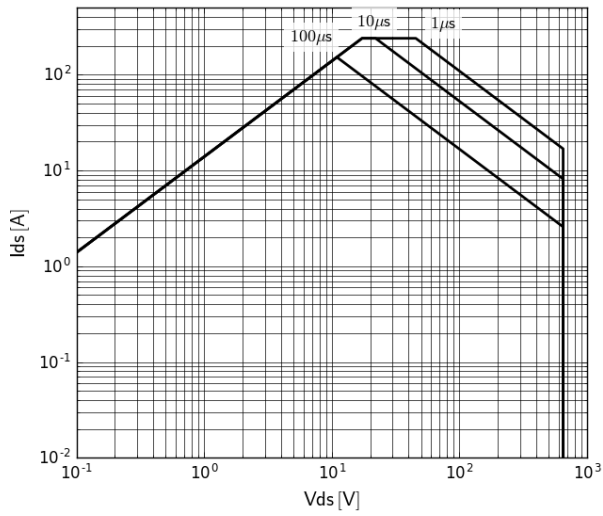

Figure 13. Safe Operating Area $T_c=25^\circ\text{C}$

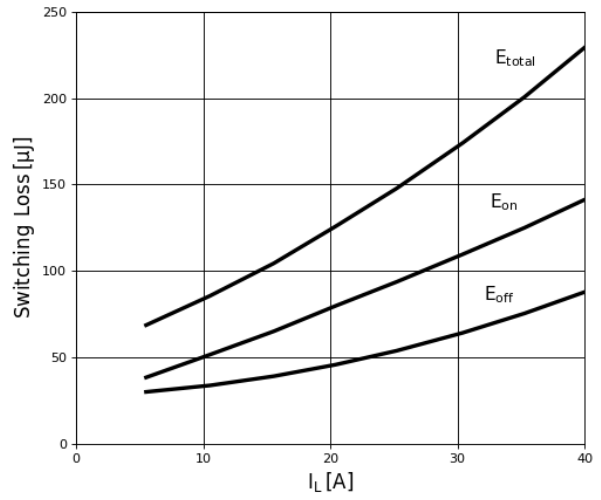

Figure 14. Inductive Switching Loss $T_c=25^\circ\text{C}$
 $R_G=30\Omega$, $V_{DS}=400\text{V}$

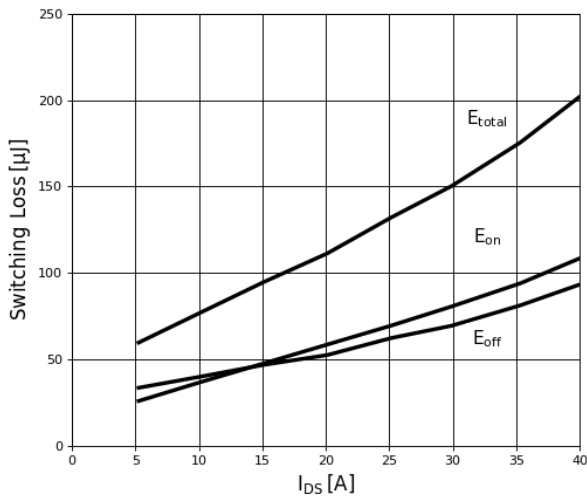

Figure 15. Inductive Switching Loss $T_c=25^\circ\text{C}$
 $R_{G(on)}=10\Omega$, $R_{G(off)}=30\Omega$, $V_{DS}=400\text{V}$

Test Circuits and Waveforms

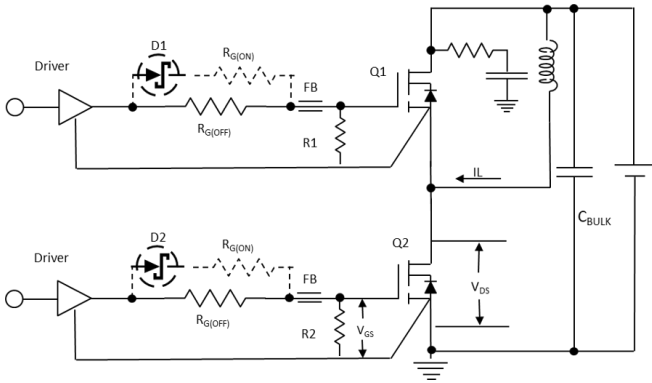

Figure 16. Switching Time Test Circuit

(see circuit implementation on page 3 for methods to ensure clean switching)

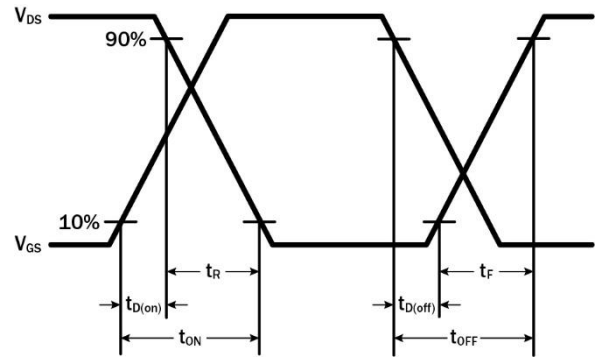

Figure 17. Switching Time Waveform

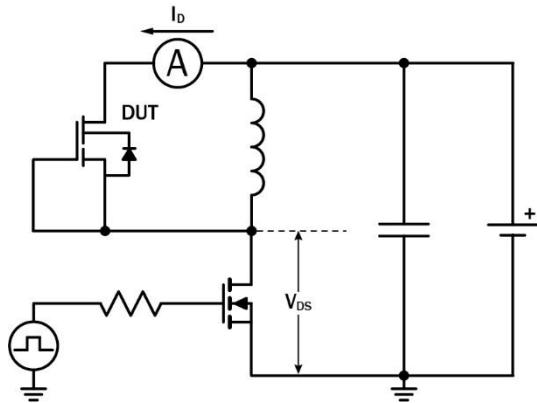

Figure 18. Diode Characteristics Test Circuit

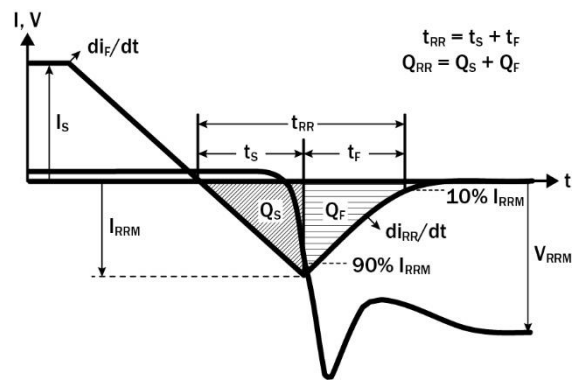

Figure 19. Diode Recovery Waveform

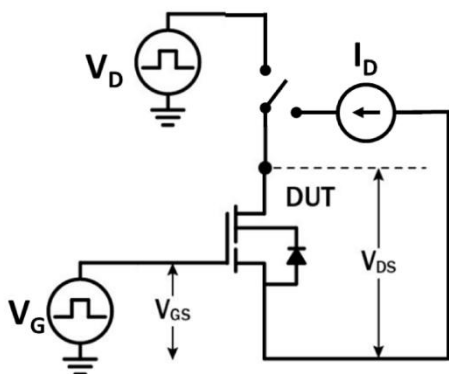

Figure 20. Dynamic $R_{DS(on)eff}$ Test Circuit

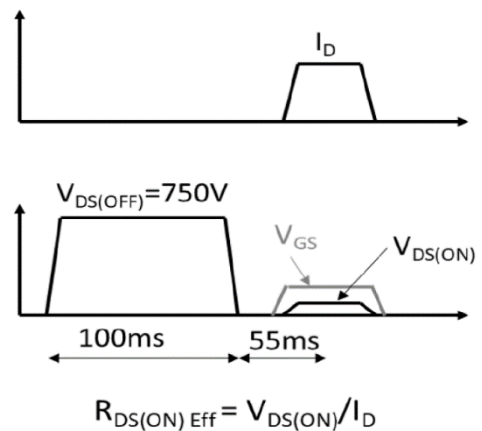
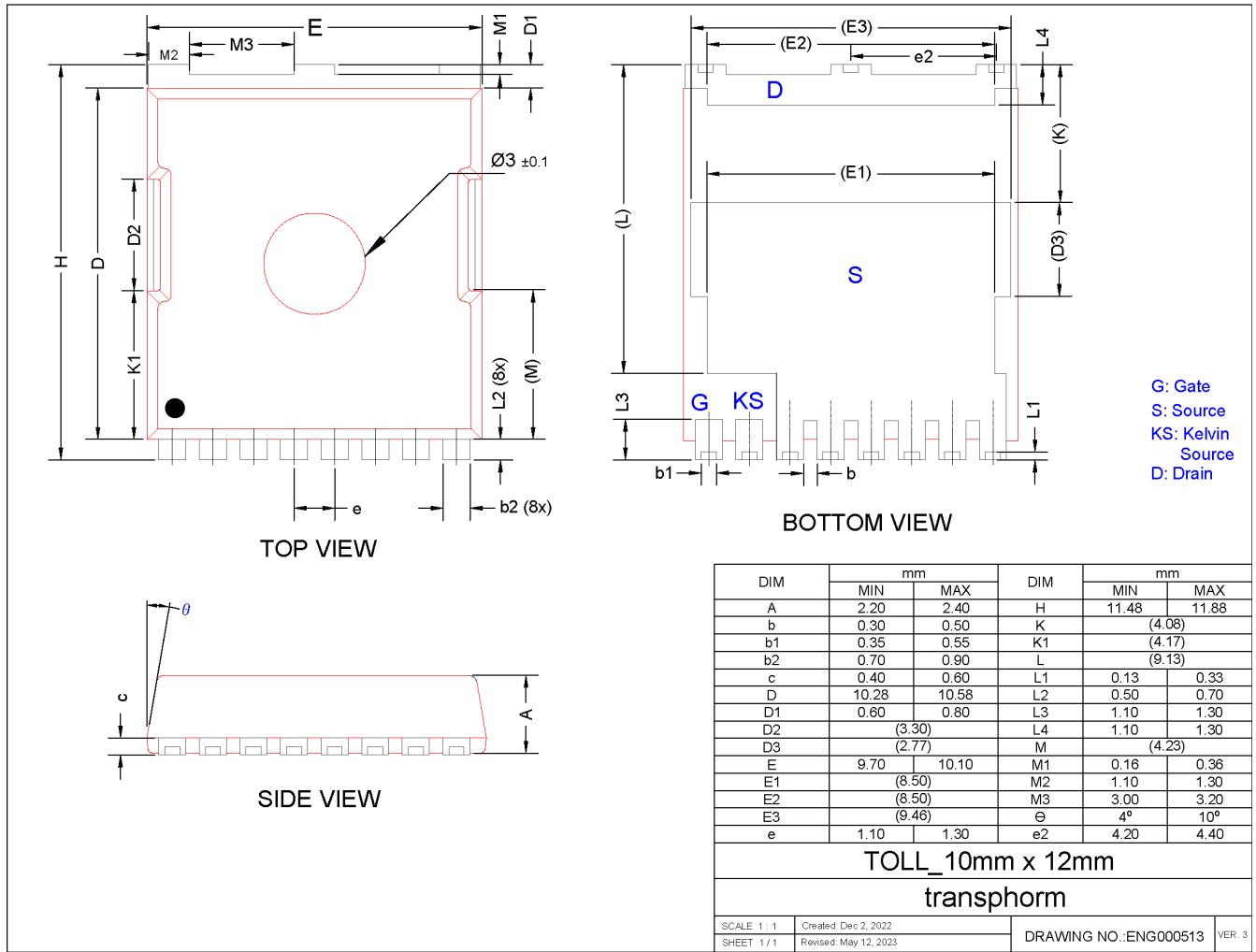
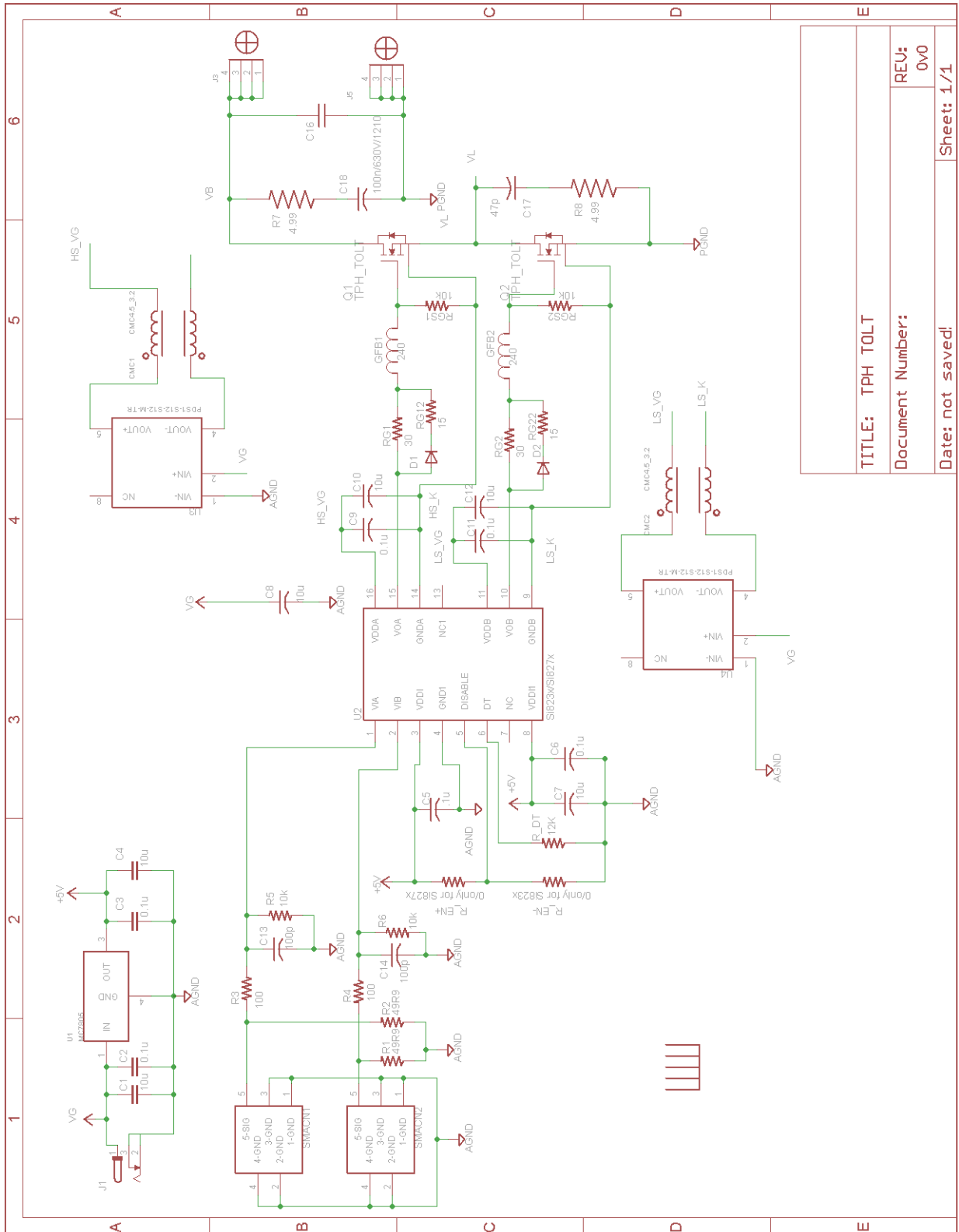

Figure 21. Dynamic $R_{DS(on)eff}$ Waveform



Half-bridge Reference Schematic



TITLE: TPH TOLT	
Document Number:	REV: 0v0
Date: not saved!	Sheet: 1/1

Design Considerations

The fast switching of GaN devices reduces current-voltage crossover losses and enables high frequency operation while simultaneously achieving high efficiency. However, taking full advantage of the fast switching characteristics of GaN switches requires adherence to specific PCB layout guidelines and probing techniques.

Before evaluating Renesas GaN devices, see application note [Printed Circuit Board Layout and Probing for GaN Power Switches](#). The table below provides some practical rules that should be followed during the evaluation.

When Evaluating Renesas GaN Devices:

DO	DO NOT
Minimize circuit inductance by keeping traces short, both in the drive and power loop	Twist the pins of TO-220 or TO-247 to accommodate GDS board layout
Minimize lead length of TO-220 and TO-247 package when mounting to the PCB	Use long traces in drive circuit, long lead length of the devices
Use shortest sense loop for probing; attach the probe and its ground connection directly to the test points	Use differential mode probe or probe ground clip with long wire
See Printed Circuit Board Layout and Probing	

GaN Design Resources

The complete technical library of GaN design tools can be found at [Renesasusa.com/design](https://www.renesas.com/design):

- Evaluation kits
- Application notes
- Design guides
- Simulation models
- Technical papers and presentations