

# RENESAS SYNERGY™ PLATFORM

A complete, qualified solution for faster and easier embedded development





# IT'S TIME TO **RETHINK EMBEDDED DESIGN**

**Huge opportunities await developers who can rise to the challenge.**

## **Exponential growth. Exponential pressures.**

To be competitive and succeed in the vibrant IoT (Internet of Things) arena, embedded system developers must not only innovate and differentiate their products, but also accelerate their time to market.

Moreover, today system engineers are challenged to design products that deliver more complex functionality, offer multiple connectivity options, and achieve better performance, while also providing higher levels of security.

Time pressures are enormous because application opportunities arise, expand, and mature at ever-faster rates.

## **The clock is ticking on your next design.**

Product lifecycles continue to shrink as companies race to gain market share across product segments. Time to market is a serious issue, and obstacles that extend it become critically important.

## Conventional development challenges.

In traditional embedded development, software and hardware must be sourced, entailing up-front costs that can be significant for companies. Also, operational behaviors of MCU peripherals have to be understood and the RTOS, middleware, and application must be integrated. This time-consuming engineering process requires interfacing with multiple vendors, as well as overcoming code debugging and quality-control challenges.

Additionally, new entrants to some market segments face another problem: complying with standards and regulations applicable to the end product's hardware and software.

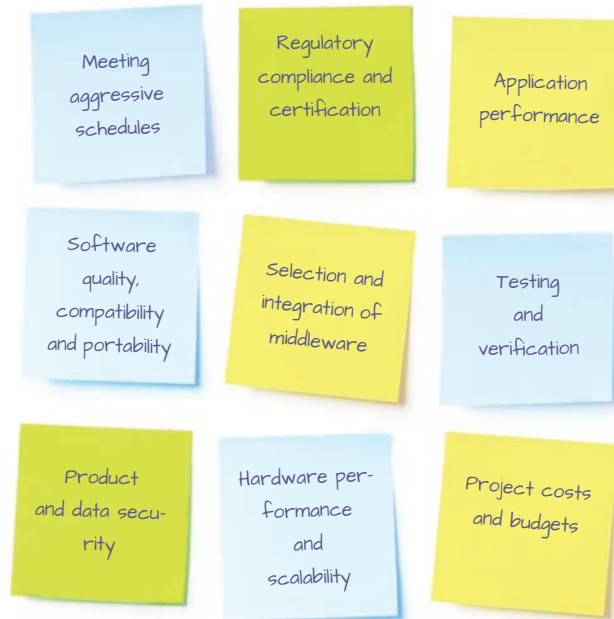

Embedded software developers have major concerns that must be considered when beginning a new design.

A new engineering plan of action exists, and it's becoming increasingly popular. It applies an integrated method of operating and developing.

## The better way.

A platform-based approach allows a simplified development strategy. It eliminates unnecessary design effort, saves time, and facilitates the timely production of IoT products. Also, it minimizes risk and cost over the long run.

The Renesas Synergy™ Platform is the modern, efficient, cost-effective way to develop and produce IoT products faster and smarter.

## Development delays cost time and money.

Products entering late into the fast-moving IoT environment generate much less profit. They can even face exclusion as the market moves on and sales of older designs quickly vanish. Delays of just a few weeks can cause major losses of market share and associated revenue. For example, a product delayed by six months in a product category that has a five-year life span might experience a 96% revenue loss.

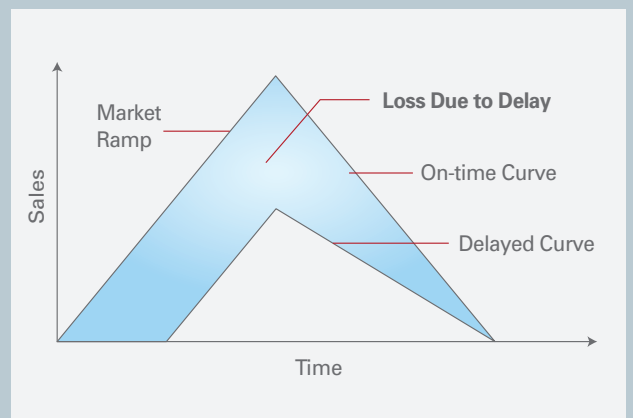

Renesas Synergy™ Platform

# START PROJECTS EARLIER AND FINISH FASTER

A comprehensive platform that makes IoT development easier.

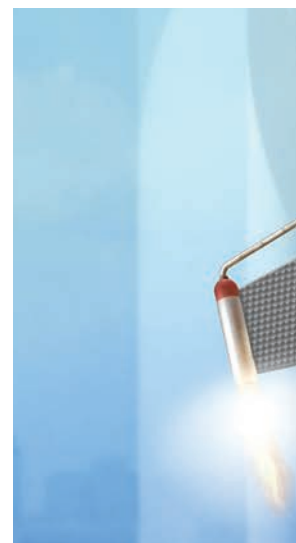

The Renesas Synergy™ Platform is a complete, qualified system solution. It includes software, a scalable family of microcontrollers, and development tools.

With this comprehensive, proven platform, engineering teams can begin IoT application software development at the API level, saving them months of time and effort. It also ensures that their product

innovations rest on a solid, robust technology foundation optimized for MCU-based product designs.

## Accelerate time to market.

Because the Renesas Synergy™ Platform's standardized API eliminates the need to wrestle with low-level middleware and network stacks, engineers can now focus on developing and implementing innovative, differentiated products and solutions.

## Save months of development time with the Renesas Synergy™ Platform.

Using the pre-integrated Renesas Synergy™ Platform greatly shortens the development schedules of MCU-based products, getting new products into production faster.

### TRADITIONAL DESIGN PROCESS – MONOTONOUS, REPETITIVE, AND TIME CONSUMING



### THE RENESAS SYNERGY DESIGN CYCLE

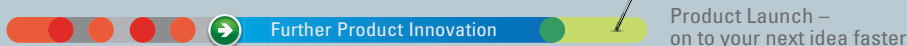



Developers can immediately start designing embedded applications simply by downloading the Synergy™ Software Package (SSP) from the Renesas Synergy Gallery at [am.renesas.com/synergycastle](http://am.renesas.com/synergycastle).

### Eliminate barriers to entry.

Many great projects never get started due to the lack of required up-front cash. Not so with the Synergy™ Platform. The price of each Synergy MCU includes full use of the entire platform, including professional software and tools. There are no fees and no royalties.

### Lower cost of ownership.

A product's total cost encompasses the BOM and R&D expenses, plus money for lifetime tool/software support and maintenance. The Synergy™ Platform eliminates much of the traditional R&D and lifetime costs, making a "Buy" decision the right one. This frees up precious resources for funding product innovation and differentiation.

#### Standardized API

- Abstracts dependencies, ensures portability, and accelerates product development
- Provides easy access to the SSP and Software Add-Ons

#### Powerful Software

- Consists of widely-deployed, commercial-grade ThreadX® RTOS, extensive Middleware, Application Frameworks, Functional Libraries, and Hardware Abstraction Layer (HAL) Drivers

#### Versatile Microcontrollers

- Comprised of low-power Cortex® M0+ MCUs to high-performance Cortex M4-based chips
- Up to 4MB of flash and cryptographic algorithms in hardware

#### Rich Tools & Kits

- Includes industry-leading IDE, debug and design tools: IAR Embedded Workbench® for Renesas Synergy™, C-RUN®, C-STAT®, GUIX™ and TraceX®
- Development Kits to jump-start evaluation

## Renesas Synergy™ Platform

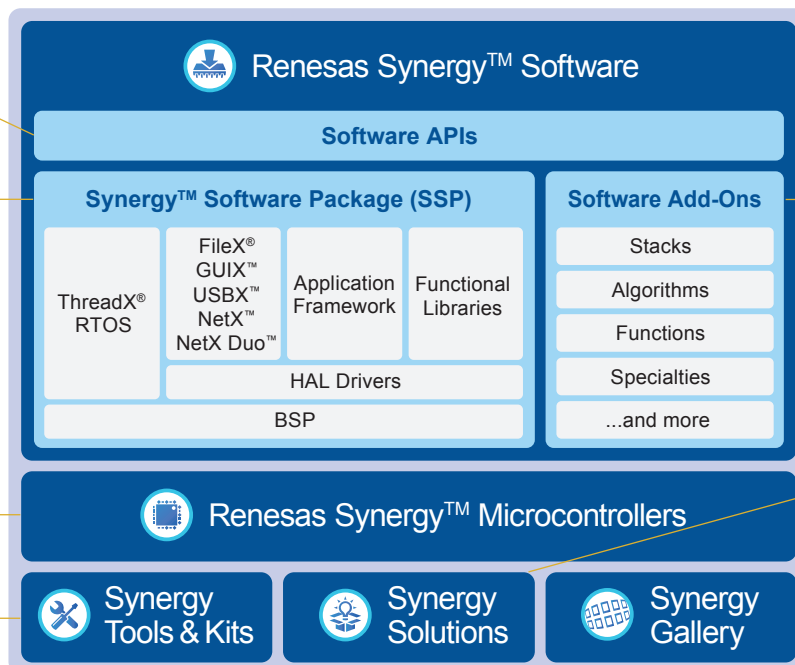

This comprehensive development platform contains everything needed—all included in the price of the MCU.

#### Software Add-Ons

- Verified Software Add-ons (VSAs) add specialty functions from third-party experts; certified by Renesas to be SSP compatible
- Qualified Software Add-ons (QSAs) are tested, licensed, and serviced by Renesas

#### Full Solution

- Application Examples (AEs) to highlight key technologies enabled by the Synergy Platform
- Product Examples (PEs) provide design instances of actual end products for a great start

#### Single-Source Delivery

- Implements the online destination for everything related to Synergy Software
- Go to production with simple click-through licensing

# SERIOUS SOFTWARE FOR SERIOUS DEVELOPERS.

Renesas Synergy™ Software Package includes ThreadX®, middleware and application frameworks

At the heart of the Renesas Synergy™ Platform is the Synergy Software Package (SSP), which is fully qualified, supported, warranted, and maintained by Renesas.

The SSP consists of a highly optimized, fully preemptive ThreadX® RTOS, extensive middleware, communications stacks, application frameworks, and more — all accessible through a robust API.

As a widely deployed RTOS, ThreadX® is field proven and certified to the highest industry standards.

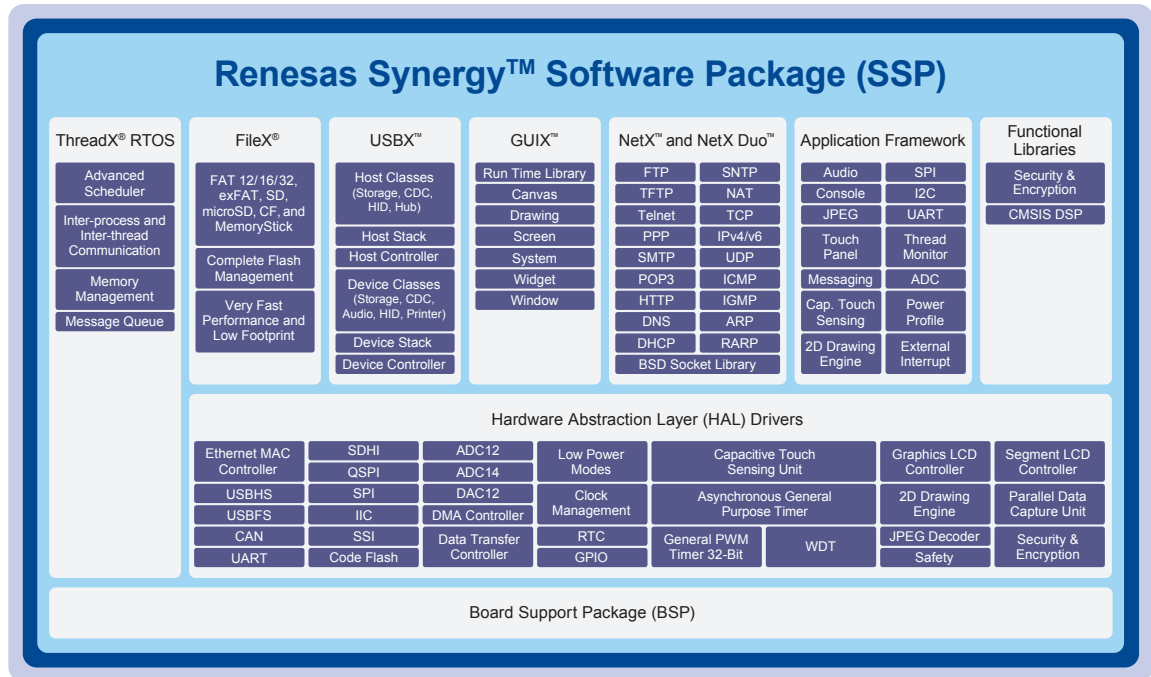

## Comprehensive Software API.

The architecture of the Synergy™ Software Package allows programmers access to all layers of the software stack, including direct access to MCU registers.

The Renesas Synergy™ Software's API provides an efficient and robust interface to well-established functions and protocols, simplifying the creation of end applications. The API is well documented in the SSP User Manual.

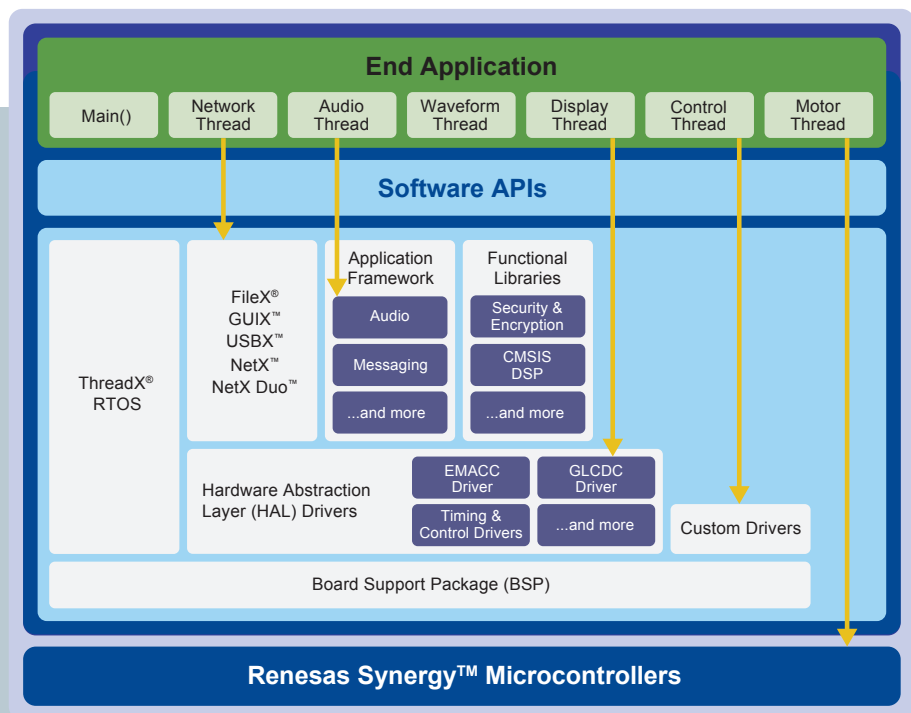

## Invest in trusted Verified and Qualified Add-Ons

Software component add-ons extend the functionality of the SSP by adding specialized capabilities. Renesas qualifies or verifies that every add-on component is tested and verified, ensuring a world-class system design experience.

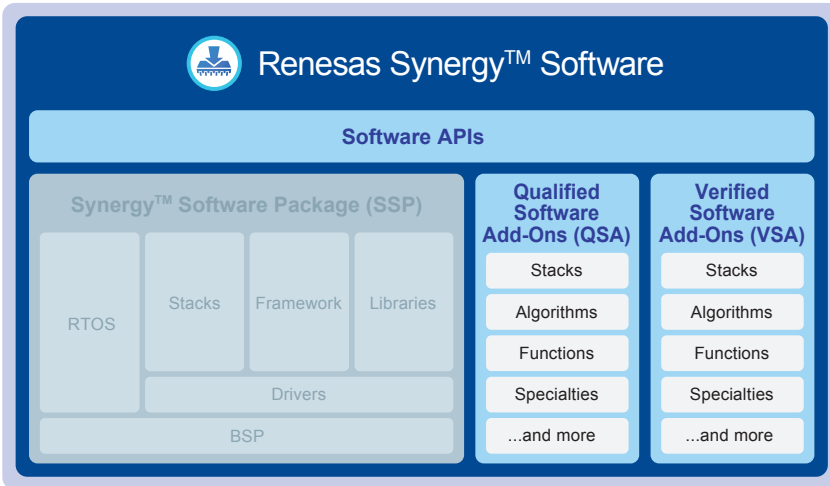

### Qualified Software Add-On (QSA)

- Qualified, licensed, and serviced by Renesas
- Tightly integrated and optimized for use with SSP APIs
- Licensed and maintained under a separate agreement from the SSP
- Qualified and maintained under the same Renesas standards as the SSP

### Verified Software Add-On (VSA)

- Third-party add-ons verified to meet Renesas compliance requirements for SSP compatibility
- VSA production software is licensed directly from third-party software vendors
- Evaluation versions of VSA add-ons are downloaded directly from the Synergy Gallery

## Meet regulatory and certification requirements

The Renesas Synergy™ Software Package was developed while keeping certification requirements for various industry segments in mind.

### Synergy Development Life Cycle (SDLC):

- Requirements and traceability, coding standards, design descriptions
- Code reviews and unit test development, continuous integration and integration reports
- Benchmarks, code size, context switch times, latencies, execution times, cyclical testing, fault tolerance and more

### Software Quality Assurance (SQA)

- Requirements traceability throughout development, SQA metrics and process artifacts available, test plans, test suites, reports



```

##SSP_VERSION##
Unity Test run 1 of 1
TEST(SF_COMMS_T01, TC_1_SF_COMMS_OpenD_dev_NULL) P
TEST(SF_COMMS_T01, TC_1_SF_COMMS_OpenD_cf0_NULL) P
TEST(SF_COMMS_T01, TC_1_SF_COMMS_CloseD_dev_NULL) P
TEST(SF_COMMS_T01, TC_1_SF_COMMS_ReadD_dev_NULL) P
TEST(SF_COMMS_T01, TC_1_SF_COMMS_ReadD_test_NULL)
TEST(SF_COMMS_T01, TC_1_SF_COMMS_WriteD_dev_NULL)
TEST(SF_COMMS_T01, TC_1_SF_COMMS_WriteD_test_NULL)
TEST(SF_COMMS_T01, TC_1_SF_COMMS_LockD_dev_NULL) P
TEST(SF_COMMS_T01, TC_1_SF_COMMS_UnlockD_dev_NULL)
TEST(SF_COMMS_T01, TC_1_SF_COMMS_VersionGet_dev_NULL)
TEST(SF_COMMS_T01, TC_1_SF_COMMS_VersionGet_test)
TEST(SF_COMMS_T01, TC_1_SimpleLockunlock) PASS
TEST(SF_COMMS_T01, TC_1_SimpleLockunlock) PASS
TEST(SF_COMMS_T01, TC_1_LockCommsChannel) PASS

-----
14 Tests 0 Failures 0 Ignored 14 Pass
OK
    
```

LDRA Testbed (R) Code Review Report			
System : r_doc			
System :	LDRA	(M) MANDATORY STANDARDS	MISRA-C:2012 CODE
r_doc	CODE		
0	36 S	Function has no return statement.	MISRA-C:2012 R.17.4
0	34 S	Sizeof operator with side effects	MISRA-C:2012 R.13.6
0	66 S	Function with empty return expression	MISRA-C:2012 R.17.4
0	407 S	free used on string	MISRA-C:2012 R.22.2
0	480 S	String function params access same variable.	MISRA-C:2012 R.10.1
0	492 S	free parameter is not heap item.	MISRA-C:2012 R.22.2
0	684 S	Attempt to use already freed object.	MISRA-C:2012 R.22.2
0	685 S	Function call with no prior declaration	MISRA-C:2012 R.17.3
0	545 S	Assignment of overlapping storage.	MISRA-C:2012 R.10.1
0	394 S	Inappropriate use of file pointer.	MISRA-C:2012 R.22.9
0	614 S	Use of static keyword in array parameter.	MISRA-C:2012 R.12.6
0	631 S	Declaration not reachable.	MISRA-C:2012 R.9.1
0	2 D	Function does not return a value on all paths.	MISRA-C:2012 R.17.4
0	48 D	Attempt to write to unopened file.	MISRA-C:2012 R.22.6
0	51 D	Attempt to read from freed memory.	MISRA-C:2012 R.22.2
0	53 D	Attempt to use uninitialised pointer.	MISRA-C:2012 R.9.1
0	69 D	Procedure contains UI data flow anomalies.	MISRA-C:2012 R.9.1
0	98 D	Attempt to write to file opened read only.	MISRA-C:2012 R.22.4
0	119 D	File closed more than once.	MISRA-C:2012 R.22.6

### Industry Compliant

- MISRA C:2012 – guidelines for the use of the C language in critical systems
- ISO/IEC/IEEE 12207 – software life cycle processes
- Self-test libraries and supporting artifacts available for functional safety certification

# RTOS AND MIDDLEWARE. IT'S ALL INCLUDED WITH THE RENESAS SYNERGY™ PLATFORM.

Real-time operating system is optimized for size, performance, and ease of use on Synergy MCUs

The Synergy™ Platform integrates Express Logic's popular ThreadX® real-time operating system. This RTOS ensures reliable system operation, supports an API that allows portability across Synergy MCUs, and minimizes the length of system development cycles. ThreadX® RTOS features an extremely fast, commercial multitasking real-time kernel with preemptive scheduling and a small memory footprint.

## Express Logic's ThreadX® RTOS Features

- Small FLASH footprint
  - Less than 2 kB on Synergy processor families
- Small RAM requirements
  - Minimum of <1 kB for kernel RAM
- Fast Context Switch
  - 0.7 ms on Synergy S7G2 MCU Group
- Optimized for Synergy MCUs with stack bounds checking and Cortex®-M optimizations
- Intuitive API
- Multiple scheduling algorithms (Fully Preemptive, Round-Robin, Preemption-Threshold™)
- Real-time event trace
- Fully deterministic
- Certified by SGS-TUV Saar for use in safety-critical systems according to IEC-61508 SIL 4, IEC-62304 SW Safety Class C, ISO 26262 ASIL D and EN 50128



## Conquer the integration gap with the Synergy™ Platform.

A major benefit of the Synergy™ Software Package is that it eliminates the laborious R&D work associated with bridging the integration gap. This thoroughly engineered solution makes it unnecessary to write the critical code that unites stacks with I/O drivers, handles GUI frameworks with touch-screen drivers, and manages other system peripherals so IoT applications work predictably and reliably.

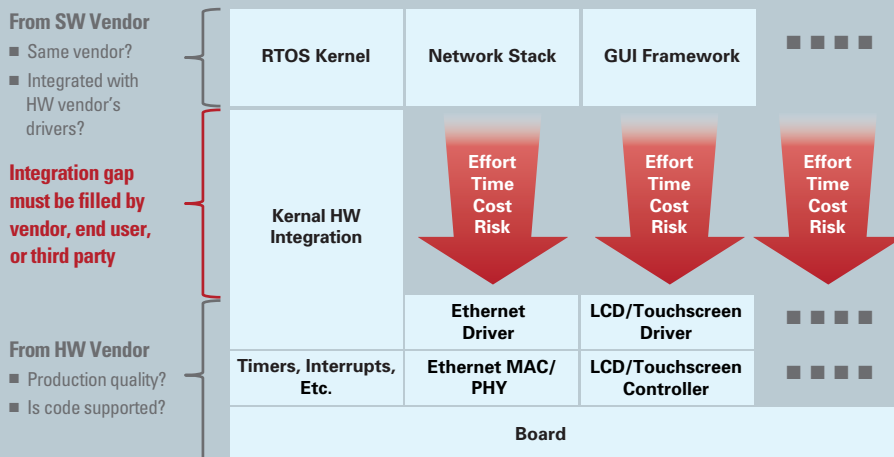

## Optimized for all Synergy MCUs.

Use Case: RTOS + USB-FS/Mass Storage, S124/S128 MCU Group (GNU Compiler)

Flash/ROM Code for RTOS and USBX	Total: 22 kB
ThreadX	
Basic Services	2 kB
Messaging, Timers, Mutex, Semaphores	8 kB
Flash/ROM Code Size	
USBX + Class	12 kB

RAM Requirements	
USBX Global Variables:	2044 bytes
USBX Memory Allocator:	3072 bytes
Application: (~10 kB available) ~	5 kB



## Advanced commercial-grade middleware and network stack included

Synergy Software includes Express Logic's X-Ware™, a complete set of commercial-grade middleware products. The easy-to-use NetX™, FileX®, USBX™, GUIX®, and TraceX® software products are all fully licensed, with no runtime royalties, and fully supported.

NetX Duo™, a streamlined TCP/IP stack, provides both IPv4 and IPv6 capabilities. Its

<b>FileX®</b>	FAT compatible file system. Supports FAT12, FAT16, FAT32 and exFAT
<b>NetX™</b>	Embedded TCP/IP Network Stack
<b>USBX™</b>	USB Host/Device Protocol Stack
<b>GUIX®</b>	Embedded GUI Development Framework
<b>TraceX®</b>	Real-Time, Graphical Event Trace/Analysis

unique Piconet™ architecture links into the final image only those services and protocols actually used by the application. NetX Duo

### NetX Duo IPv4/IPv6 TCP/IP Networking

- Optimized IPv4/IPv6 Dual TCP/IP stack for embedded systems
- Small footprint, ThreadX-optimized performance
- "Near Wire Speed" on Iperf network throughput benchmark
- TCP, UDP, IP, ARP, RARP, IGMP, and ICMP core support
- Network configuration protocols
- DHCP client/server (dynamic address allocation)
  - DHCPv6 (client only)
  - SNTP (network time protocol)
- Domain name services
  - DNS, mDNS, DNS-SD
  - DNSv6
  - NAT (private network extension)

achieves "Near Wire Speed" performance on the independent Iperf benchmark suite and has obtained IPv6 Ready Logo certification.

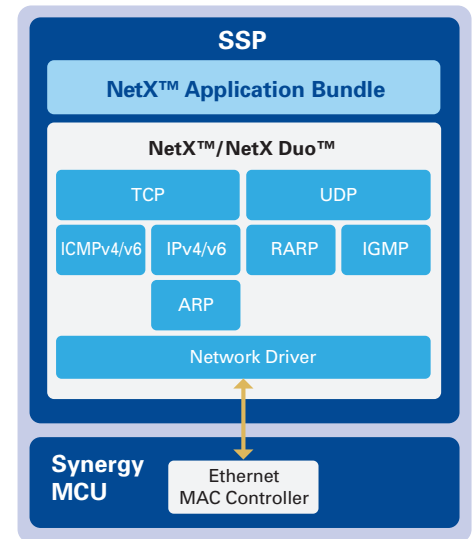

Streamlined TCP/IP stack in NetX Duo provides both IPv4 and IPv6 capabilities, easing the design of IoT products that utilize TCP/IP network communication.

## An RTOS can provide benefits.

Using an RTOS provides numerous benefits. It ensures system reliability and delivers fast, guaranteed real-time responsiveness that preserves system performance in time-critical situations. In most cases, an RTOS is better than application code for handling interrupts, implementing scheduling, and performing other tasks. In all but the simplest embedded designs, a real-time operating system actually reduces application overhead. Additional benefits include accelerated system development, easier feature upgrades, and simplified application ports.

Function	Application Code	RTOS Service	RTOS Service Time	Application Code Service Time
Handle Interrupt	ISR	ISR	Processor dependent	Processor dependent
Scheduling	Loop	Context Switch	~1 $\mu$ s @100 MHz	Depends on size/contents of polling loop
Queue	Copy message/linked list	Copy 1 to "n" 32-bit words	~.8 $\mu$ s @100 MHz	Similar to RTOS performance
Timer	Setup, manage timer interrupts	Timer Services	~1 $\mu$ s @100 MHz	For one timer, similar to RTOS. For more than one timer, RTOS likely less overhead
Delay	Loop	Sleep Service	~1.8 $\mu$ s @100 MHz	Similar to RTOS, except RTOS can do something useful (another thread) while delay is in effect

The ThreadX RTOS achieves fast response times for handling time-critical operations, while also delivering benefits that application code can't provide.

# RENESAS SYNERGY MICROCONTROLLERS. RANGE, FEATURES, SCALABILITY, AND MUCH MORE.

## Performance and capabilities for the highest quality embedded system products

The Renesas Synergy™ Platform includes four different series of upward software-, architecture-, and pin-compatible Synergy MCUs. The advanced S7 Series (High Performance), S5 Series (High Integration), S3 Series (High Efficiency), and S1 Series (Ultra Low Power) MCUs

utilize the popular ARM® Cortex®-M CPU architecture. The devices implement easy connectivity, rock-solid security, dependable safety, and facilitate the creation of easy-to-use human-machine interfaces.

The high-performance 240 MHz S7 Series MCUs feature secure connectivity and industry-leading flash memory density.



### KEY FEATURES

- Cortex-M4, 240 MHz, 2.7 V to 3.6 V, 75 µA/MHz
- 40-nm high-performance process
- Operating temperature range -40° C to 105° C
- USBHS, IEEE 1588 PTP Ethernet MAC, QSPI External Memory Bus
- 4 MB and 3 MB Flash, 640 KB SRAM, Memory Mirror Function, Memory Protection Unit
- 12-bit A/D, Programmable Gain Amplifier
- JPEG Codec, 2D Drawing Engine, WVGA (800x480) with 32-bit color
- Features to address functional safety requirements
- Industry-leading, NIST-compliant security features: hardware acceleration for cryptography and HASH algorithms, true random number generator, secure key generation and storage, 128-bit unique ID, and more

The highly integrated 120 MHz S5 Series MCUs balance processing performance with large memory and an extensive array of built-in features.



### KEY FEATURES

- Cortex-M4, 120 MHz, 2.7 V to 3.6 V, 117 µA/MHz
- 40-nm high-performance process
- Operating temperature range -40° C to 105° C
- Comprehensive and flexible connectivity including USBHS, Ethernet PTP, QSPI External Memory Bus, and more
- 2 MB Flash, 640 KB SRAM, Memory Mirror Function, Memory Protection Unit
- 12-bit A/D, Programmable Gain Amplifier
- JPEG Codec, 2D Drawing Engine, WVGA (800x480) with 32-bit color
- Features to address functional safety requirements
- Industry-leading, NIST-compliant security features: hardware acceleration for cryptography and HASH algorithms, true random number generator, secure key generation and storage, 128-bit unique ID, and more

High-efficiency 48 MHz S3 Series MCUs are low-power chips that integrate up to 1 MB of Flash and 192 kB of SRAM.



### KEY FEATURES

- Cortex-M4, 48 MHz, 1.6 V to 5.5 V
- 130-nm low power process
- Operating temperature range -40° C to 105° C
- External Memory Bus
- 1 MB Flash, 192 kB SRAM, Memory Mirror Function, Memory Protection Unit
- 12-bit A/D, Programmable Gain Amplifier
- 28-channel 14-bit A/D
- Capacitive Touch Sensing Unit with Segment LCD Controller
- ECC and Parity Error Check in SRAM, ADC Diagnostics, CRC Calculator
- NIST-compliant security features: hardware acceleration for cryptography and HASH algorithms, true random number generator, secure key generation and storage, unique ID, and more

Ultra-low-power 32 MHz S1 Series MCUs operate down to 1.6 V and feature low-power operating modes and fast wake-up times.



### KEY FEATURES

- Cortex-M0+, 32 MHz, 1.6 V to 5.5 V, 440 nA (Software Standby Mode), 70 µA/MHz
- 18-channel 14-bit ADC
- 31-channel Capacitive Touch Sensing Unit
- USBFS, CAN
- Real-Time Clock
- SRAM Parity Error Check, ADC Diagnostics, CRC Calculator, Flash Area Protection
- NIST-compliant security features: hardware acceleration for cryptography and HASH algorithms, true random number generator, secure key generation and storage, unique ID, and more

## Features and capabilities of pin-compatible and scalable MCUs

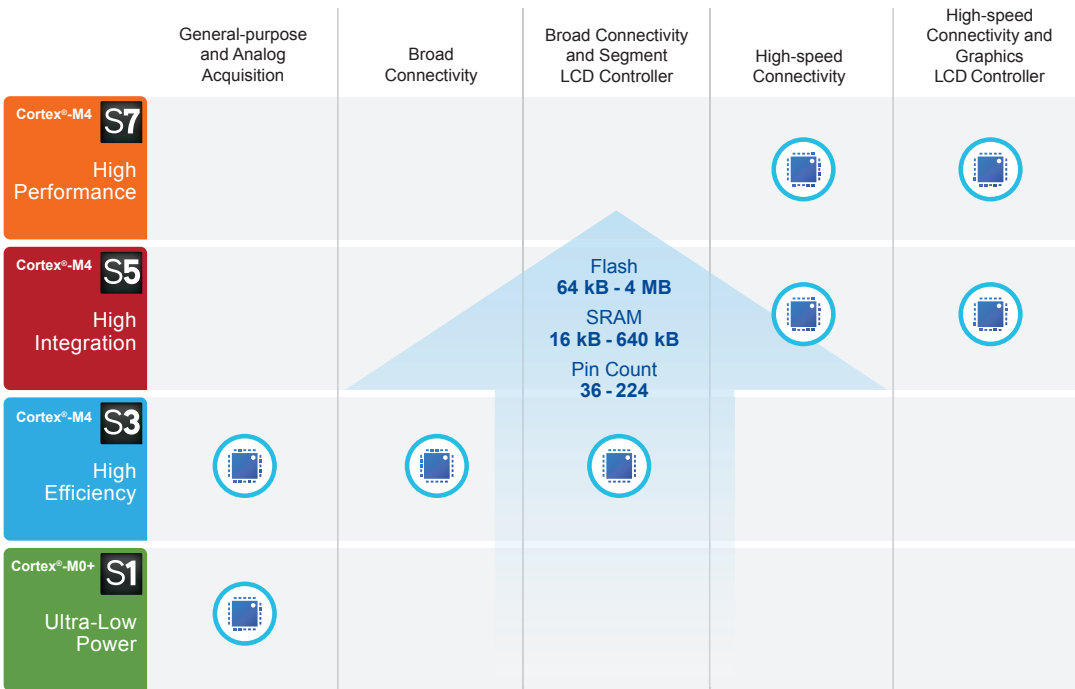

The capabilities provided by S7, S5, S3, and S1 Series MCUs readily handle a wide range of applications, from ultra-small mobile devices to calculation-intensive industrial systems, medical equipment, and more. The rigorously enforced compatibilities expand system design flexibility and help conserve development resources.

No matter the requirements of an IoT application, there is a Synergy MCU that can meet them.

## Scalable MCUs designed with software in mind.

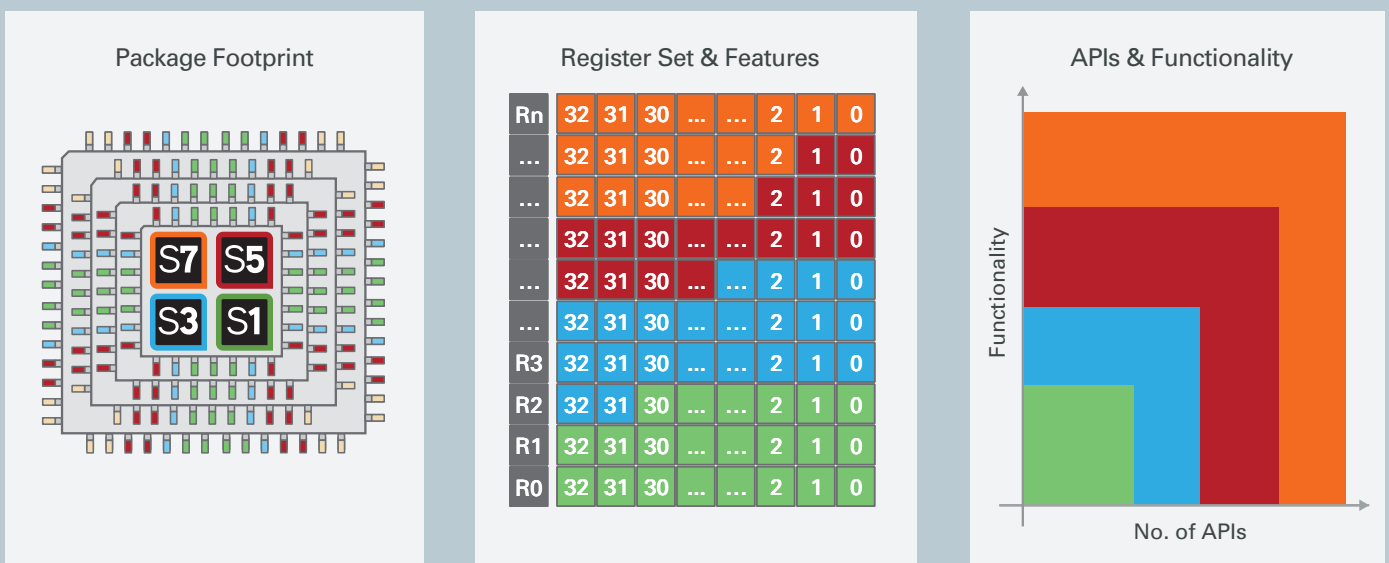

Compatibilities are rigorously enforced for Synergy MCUs. This configuration discipline ensures the design flexibility needed to leverage engineering investments for diverse opportunities in local and global IoT markets.

# FEATURE-RICH, SCALABLE MCUs.

## S7 Series

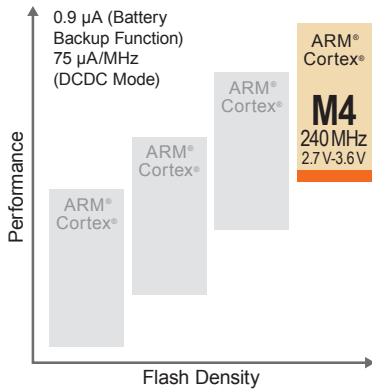

- 40-nm high-performance process
- Operating temperature range: -40° C to 105° C
- GPIO pins: up to 172
- Package LQFP: 100, 144, 176
- Package BGA: 176, 224
- Package LGA: 145

## 240 MHz ARM® Cortex®-M4 CPU

**S7**

FPU | ARM MPU | NVIC | ETM  
JTAG | SWD | Boundary Scan

Memory	Analog	Timing & Control	HMI
Code Flash (4 MB)	12-Bit A/D Converter x2 (25 ch.)	General PWM Timer 32-bit Enhanced High Resolution x4	Capacitive Touch Sensing Unit (18 ch.)
Data Flash (64 kB)	12-Bit D/A Converter x2	General PWM Timer 32-bit Enhanced x4	Graphics LCD Controller
SRAM (640 kB)	High-Speed Analog Comparator x6	General PWM Timer 32-bit x6	2D Drawing Engine
Flash Cache	PGA x6	Asynchronous General Purpose Timer x2	JPEG Codec
MPUs	Temperature Sensor	WDT	Parallel Data Capture Unit
Memory Mirror Function			
Connectivity	System & Power Management	Safety	Security & Encryption
Ethernet MAC Controller x2	DMA Controller (8 ch.)	SRAM Parity Error Check	128-bit Unique ID
Ethernet DMA Controller	Data Transfer Controller	Flash Area Protection	TRNG
Ethernet PTP Controller	Event Link Controller	ADC Diagnostics	AES (128/192/256)
USBHS   USBFS	Low Power Modes	Clock Frequency Accuracy Measurement Circuit	3DES/ARC4
CAN x2   SDHI x2	Switching Regulator	CRC Calculator	RSA/DSA
Serial Communications Interface x10	Multiple Clocks	Data Operation Circuit	SHA1/SHA224/SHA256
IrDA Interface	Port Function Select	Port Output Enable for GPT	GHASH
QSPI   SPI x2	RTC	IWDT	
IIC x3   SSI x2	SysTick		
Sampling Rate Converter			
External Memory Bus			

## S5 Series

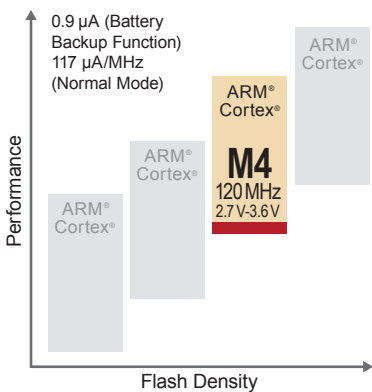

- 40-nm high-performance process
- Operating temperature range: -40° C to 105° C
- GPIO pins: up to 133
- Package LQFP: 100, 144, 176
- Package BGA: 176
- Package LGA: 145

## 120 MHz ARM® Cortex®-M4 CPU

**S5**

FPU | ARM MPU | NVIC | ETM  
JTAG | SWD | Boundary Scan

Memory	Analog	Timing & Control	HMI
Code Flash (2 MB)	12-bit A/D Converter x2 (24 ch.)	General PWM Timer 32-bit Enhanced High Resolution x4	Capacitive Touch Sensing Unit (18 ch.)
Data Flash (64 kB)	12-bit D/A Converter x2	General PWM Timer 32-bit Enhanced x4	Graphics LCD Controller
SRAM (640 kB)	High-Speed Analog Comparator x6	General PWM Timer 32-bit x6	2D Drawing Engine
Flash Cache	PGA x6	Asynchronous General Purpose Timer x2	JPEG Codec
MPUs	Temperature Sensor	WDT	Parallel Data Capture Unit
Memory Mirror Function			
Connectivity	System & Power Management	Safety	Security & Encryption
Ethernet MAC Controller	DMA Controller (8 ch.)	ECC in SRAM	128-bit Unique ID
Ethernet DMA Controller	Data Transfer Controller	SRAM Parity Error Check	TRNG
Ethernet PTP Controller	Event Link Controller	Flash Area Protection	AES (128/192/256)
USBHS   USBFS	Low Power Modes	ADC Diagnostics	3DES/ARC4
CAN x2   SDHI x2	Multiple Clocks	Clock Frequency Accuracy Measurement Circuit	RSA/DSA
Serial Communications Interface x10	Port Function Select	CRC Calculator	SHA1/SHA224/SHA256
IrDA Interface	RTC	Data Operation Circuit	GHASH
QSPI   SPI x2	SysTick	Port Output Enable for GPT	
IIC x3   SSI x2		IWDT	
Sampling Rate Converter			
External Memory Bus			

**48 MHz ARM® Cortex®-M4 CPU** **S3** FPU | ARM MPU | NVIC | ETM  
JTAG | SWD | Boundary Scan

Memory	Analog	Timing & Control	HMI
Code Flash (1 MB) Data Flash (16 kB) SRAM (192 kB) Flash Cache MPUs Memory Mirror Function	14-bit A/D Converter (28 ch.) 12-bit D/A Converter x2 Low-Power Analog Comparator x2 High-Speed Analog Comparator x2 OPAMP x4 Temperature Sensor	General PWM Timer 32-bit x10 Asynchronous General Purpose Timer x2 WDT	Capacitive Touch Sensing Unit (31 ch.) Segment LCD Controller
Connectivity	System & Power Management	Safety	Security & Encryption
USBFS CAN SDHI Serial Communications Interface x6 IrDA Interface QSPI SPI x2 IIC x3 SSI x2 External Memory Bus	DMA Controller (4 ch.) Data Transfer Controller Event Link Controller Low Power Modes Multiple Clocks Port Function Select RTC SysTick	ECC in SRAM SRAM Parity Error Check Flash Area Protection ADC Diagnostics Clock Frequency Accuracy Measurement Circuit CRC Calculator Data Operation Circuit Port Output Enable for GPT IWD	128-bit Unique ID TRNG AES (128/256) GHASH

**S3 Series**

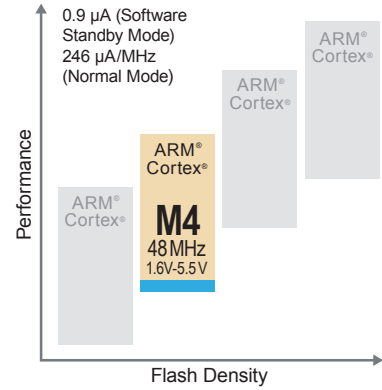

- 130-nm low-power process
- Operating temperature range: -40° C to 105° C
- GPIO pins: up to 124
- Package LQFP: 64, 100, 144
- Package BGA: 121
- Package LGA: 100, 145
- Package QFN: 64

**32 MHz ARM® Cortex®-M0+ CPU** **S1** NVIC | SWD | MTB

Memory	Analog	Timing & Control	HMI
Code Flash (128 kB) Data Flash (4 kB) SRAM (16 kB)	14-bit A/D Converter (18 ch.) 12-bit D/A Converter Low-Power Analog Comparator x2 Temperature Sensor	General PWM Timer 32-bit General PWM Timer 16-Bit x6 Asynchronous General Purpose Timer x2 WDT	Capacitive Touch Sensing Unit (31 ch.)
Connectivity	System & Power Management	Safety	Security & Encryption
USBFS CAN Serial Communications Interface x3 SPI x2 IIC x2	Data Transfer Controller Event Link Controller Low Power Modes Multiple Clocks Port Function Select RTC SysTick	SRAM Parity Error Check Flash Area Protection ADC Diagnostics Clock Frequency Accuracy Measurement Circuit CRC Calculator Data Operation Circuit Port Output Enable for GPT IWD	128-bit Unique ID TRNG AES (128/256)

**S1 Series**

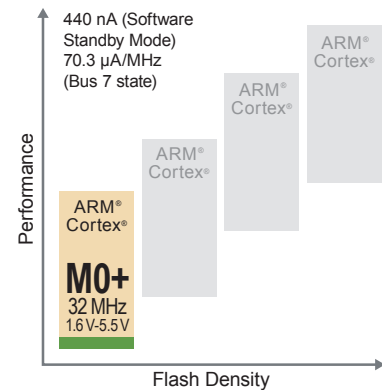

- 130-nm low-power process
- Operating temperature range: -40° C to 105° C
- GPIO pins: up to 51
- Package QFN: 40, 48, 64
- Package LQFP: 48, 64
- Package LGA: 36

# PACKED WITH POWERFUL, INDUSTRY-LEADING TOOLS.

## Take advantage of e<sup>2</sup> studio Integrated Solution Development Environment (ISDE)

Renesas' eclipsed-based e<sup>2</sup> studio is a complete development and debugging environment. It features additional e<sup>2</sup> tools and plug-ins that guide, assist, error-check, and make alternate recommendations while configuring the Synergy Platform.

### Tools include:

- Graphical interface to configure MCU pin assignments, the clock tree, and interrupt sources
- Graphical interface to configure RTOS modules, peripheral drivers, and middleware
- Smart manual offers immediate reference to user manual information just by hovering the cursor over highlighted MCU register names and API structures



### Key Features

- Automatic code generation
- A comprehensive smart user manual
- Built-in platform syntax awareness
- Powerful code navigation
- Jump to declarations
- Superior code navigation
- Code templates
- Auto code complete

## Full-featured IAR Embedded Workbench for Synergy included!

IAR Embedded Workbench for Renesas Synergy is a complete C/C++ compiler and debugger toolchain that offers sophisticated code optimization technology in a feature-rich IDE. Also included in the Platform are the static-analysis tool C-STAT and the runtime tool C-RUN. Synergy Platform customers are entitled to on-going IAR Embedded Workbench maintenance and technical support through Renesas. Additionally, there is no limit to the number of development seats.

### Key Features

- Popular, completely integrated development environment with compiler, assembler, linker, and debugger
- Includes Editor, Project Manager, and Library tools with ISO/ANSI C and C++ libraries and source
- Leading code speed and size performance, optimized for the Synergy devices
- Powerful code analysis to ensure high-quality application code
- Comprehensive debugger with smart features
- Example projects for Synergy evaluation boards to help jump-start projects
- Support for all ARM cores to maximize system design versatility
- Award-winning documentation with user and reference guides, plus excellent technical assistance

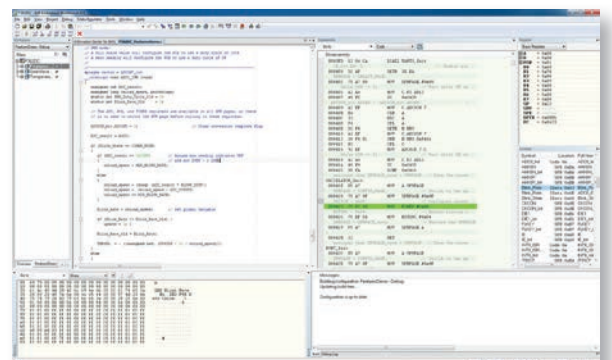

IAR Embedded Workbench for Renesas Synergy provides an uninterrupted workflow and a single, comprehensive toolbox in which all components integrate seamlessly, facilitating rapid product development.

## Simplify user interface design with GUIX™ Studio

GUIX Studio — Express Logic’s PC software design tool — provides a complete WYSIWYG screen design environment. Drag-and-drop graphical elements are used to build user-interface screens, a process that is quicker and easier than programming a complete HMI using GUIX APIs. The simplified screen-build process allows graphic artists and other non-programmers to produce professional GUIs. This gives software engineers more time to focus on higher priority system design tasks.

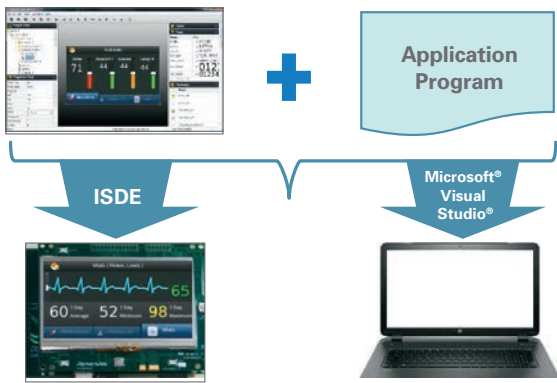

### Key Features

- WYSIWYG screen design environment
- Easy drag-and-drop design process
- Font generation tools included
- Multiple language support
- PNG & JPEG graphics importable
- Rich set of pre-built widgets: buttons, lists, icons, sliders, gauges, etc.
- Automatic code generation for PC-based or Renesas Synergy™ target hardware-based operation
- Same code used for PC and Target HW
- PC-based ThreadX® and GUIX framework for accurate prototyping
- Identical drawing functions on both PC and Synergy HW

GUIX Studio makes it easy to demonstrate UI concepts, even before target hardware becomes available. Prototyping GUIs on a host PC before compiling for the embedded target allows quick iterations.

## Visualize system performance with TraceX®

TraceX®, a desktop tool, seamlessly integrates with Synergy™ Software and other middleware components such as NetX®, providing run-time performance information. For example, if performance information is enabled for thread objects, ThreadX® keeps track of

thread resumptions, suspensions, preemptions, priority inversions, time-slices, timeouts, and much more — for each thread and for all threads collectively. By also offering run-time stack analysis, an Execution Profile Kit, and a built-in System Trace, this powerful tool helps squash bugs and speeds the software development process.

### Key Features

- Extensive event search and navigation
- Easy delta time measurements
- Sequential and Time display modes
- Automatic priority inversion detection
- Execution profile, including Idle and ISR time
- Thread stack usage profile
- Built-in performance analysis
  - Performance statistics (context-switches, etc.)
  - FileX statistics (file read/writes, etc.)
  - NetX statistics (packets sent/received, etc.)

TraceX visualizes system events.

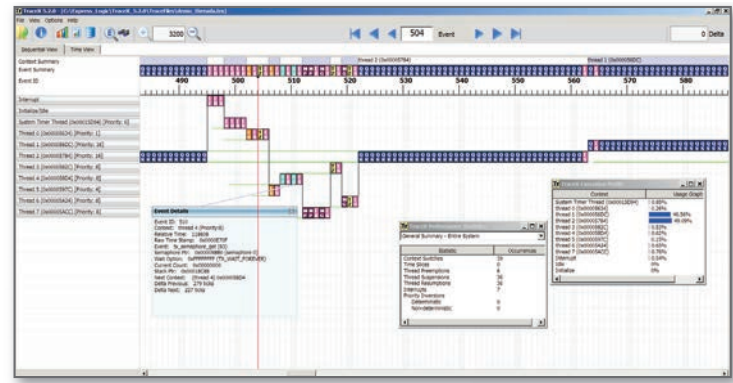

# SYNERGY™ KITS AND SOLUTIONS. GET READY, SET, GO!

A range of kit options to get you acquainted and on your way

Synergy Kits work seamlessly with Renesas' e<sup>2</sup> studio Integrated Software Development Environment (ISDE) for the Synergy Platform. Pre-configured board support packages (BSPs) are available in the e<sup>2</sup> studio ISDE for all Renesas Synergy™ Kits. The BSPs allow immediate project launches and make it easy to implement modifications that expand and alter kit capabilities.

## Development Kits (DKs)

Synergy Development Kits (DKs) are available for each Synergy MCU Group. The kits provide full access to all MCU features and pins for evaluating device performance, including measuring power consumption. They can also be used for building application software until the end product's prototype hardware development platform is available.

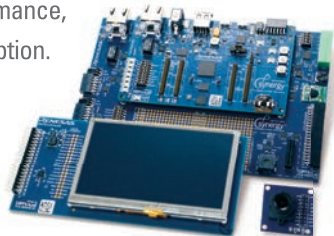

DK-S7G2 Development Kit based on the Renesas Synergy S7G2 Group MCU

Parameters	Development Kits	Starter Kits
Purpose	Complete project prototyping	Renesas Synergy Platform introduction and first steps
MCU Pin Access	All Pins	Most Pins
Expandability/Connectors	Multiple Pmods	Arduino™ and Pmod™
SSP Qualification Basis	Yes	Yes
BLE Connectivity	Yes	Yes
On-board J-Link Debugger	Yes	Yes

## Starter Kits (SKs)

Synergy Starter Kits (SKs) offer high value at very affordable prices. They provide an excellent introduction to the entire Synergy Platform and cover the vast majority of Synergy MCU functions. SKs are ideal tools for IoT product developers who may not have a specific application in mind, but want to experience and evaluate the Synergy Platform at minimal cost.

Learn more at:

[www.renesas.com/synergytools](http://www.renesas.com/synergytools)

Synergy Solutions take you to an end product quickly

The features delivered by Renesas Synergy™ Solutions' kits go beyond those of typical embedded product development kits. To give system engineers head starts on new hardware designs, these kits provide insights from actual product development projects, and they also offer bundled technologies. There are two types of Synergy Solutions: Product Examples (PEs) kits and Application Examples (AEs) kits.

## Product Examples (PEs)

Product Examples (PEs) are kits highlighting details of the design of particular end products. They closely represent the typical engineering methods and technical issues associated with the design. Synergy PE designs save time and can be reused in new IoT products. The design journey summary included in PE designs describes the decision process used by the developers of the PE product. This can help system engineers modify the PE design to meet the requirements of specific applications.



PE-HMI1 Product Example based on the Renesas Synergy S7G2 Group MCU

## Application Examples (AEs)

Application Examples (AEs) are comprehensive kits containing components that showcase the use of multiple technologies that can be leveraged using the Synergy Platform. These all-inclusive products may combine Development Kits, Product Examples, and Synergy VSA and QSA software add-ons, as well as hardware plug-ins and components from other vendors. They are full-force design accelerators that provide solid, proven foundations for new IoT products and others.

Learn more at:

[www.renesas.com/synergysolutions](http://www.renesas.com/synergysolutions)



## Easily evaluate the Renesas Synergy™ Platform with full-featured kits

### **S7** Starter Kit SK-S7G2

Starter Kit for Renesas Synergy™ S7G2

240 MHz ARM® Cortex®-M4 microcontroller in a LQFP176 package

### **S7** Development Kit DK-S7G2

Development Kit for Renesas Synergy™ S7G2

240 MHz ARM® Cortex®-M4 microcontroller in a BGA224 package

### **S5** Promotion Kit PK-S5D9

Promotion Kit for Renesas Synergy™ S5D9

120 MHz Cortex M4, in a 176-pin LQFP package, 2 MB Flash, 640 kB SRAM

### **S3** Development Kit DK-S3A7

Development Kit for Renesas Synergy™ S3A7

48 MHz ARM® Cortex®-M4 microcontroller in a LQFP144 package

### **S1** Development Kit DK-S124

Development Kit for Renesas Synergy™ S124

32 MHz ARM® Cortex®-M0+ microcontroller in a LQFP64 package

The Starter Kit SK-S7G2 is the entry point to evaluate the Synergy Platform. It covers the vast majority of Synergy MCU functions.

### **S7** Starter Kit DK-S7G2

- Compact design exercising the majority of Synergy S7G2 features and pins
- 2.4" TFT-LCD QVGA (320 x 240) color display with touchscreen operates using the internal SRAM of the S7G2 for display frame buffer memory
- Expansion
  - Arduino UNO Shield compatible connector
  - 2 x Pmod™ connectors
  - Pin row headers
- Wired connectivity
  - USB (1 x HS Host, 1 x FS Device)
  - Ethernet with RMII and IEEE 1588 Precision Time Protocol (PTP) support
  - RS232 / RS485 available on pins with transceiver
  - CAN available on pins with transceiver
- Memory
  - On-chip 4 MB flash + 640 kB SRAM + external 8-MB QSPI flash
  - Debugging and programming through J-Link® On-Board (OB)

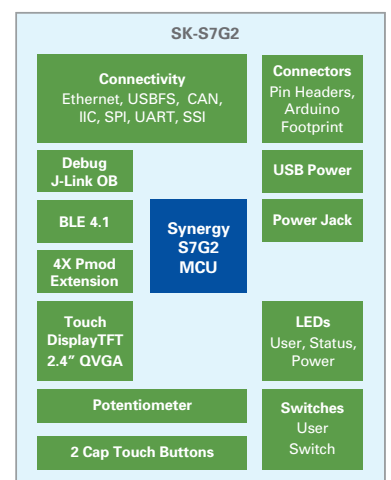

# MAKE DEVELOPMENT EASIER AND FASTER WITH A TRULY COMPLETE AND VERIFIED PLATFORM.

Adopting the Renesas Synergy™ Platform greatly accelerates the development of embedded system products for IoT markets, among others. Unlike other embedded development environments, all of the Synergy Platform elements were designed from the ground up as a single platform. This provides unprecedented scalability and compatibility, allowing developers unparalleled code reuse.

## Break through barriers to entry.

The Synergy Platform eliminates obstacles brought on by the risk of new technologies and cost of entry so you can take your next great idea to market without hesitation. Sign up and evaluate the entire Synergy Software Package at zero cost, and purchase just one Synergy MCU device to get full access to commercial software and professional tools with no additional fees or royalties.

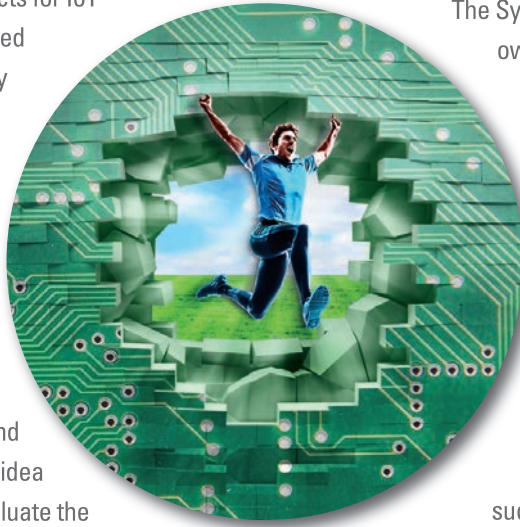

## Reduce your cost of ownership.

The Synergy Platform drastically cuts total cost of ownership by providing and maintaining the baseline platform for a fraction of the cost over the lifetime of your product.

The platform will continue to grow, adding new technologies and features over time to keep your products on the leading edge without new investments.

## Get your project rolling.

The Synergy Platform establishes a solid, proven foundation for dramatic business successes — one that continues to provide important benefits long into the future. There's never been a better opportunity to streamline development, innovate more easily, and get to market quickly.

## Visit the Renesas Synergy™ Gallery.

Log in to the Synergy Gallery, the online source for everything related to Synergy software, to download and evaluate the latest fully-featured Synergy Software Package and IAR Embedded Workbench for Synergy, and explore the Verified Software Add-Ons.

[www.renesas.com/synergycastle](http://www.renesas.com/synergycastle)



## Learn about Synergy with Synergy Xplorer.

The Renesas Synergy Xplorer website contains the latest information and data about all aspects of the Synergy product line, from chips to kits, software to tools, and more. Browsing through the extensive content will inspire interest, answer questions, and open the door to a faster, easier way to IoT product design successes.

<http://synergyexplorer.renesas.com/>



# The Renesas Synergy™ Platform At-a-Glance

## Synergy Software Package (SSP)

- ThreadX® Real Time Operating System (RTOS)
- NetX™ and NetX Duo™ IPv4/IPv6 TCP/IP networking stack with protocols: DNS, AutoIP, DHCP, FTP HTTP, SMTP, POP3, PPP, UDP, and more
- Phase-2 IPv6 Ready Logo certification
- USBX™ USB host/device/OTG stack
- GUIX™ graphical user interface framework with WYSIWYG GUIX™ Design Studio
- FileX® 12/16/32 FAT. exFAT-compatible file system
- Standardized multi-layer API:
  - ThreadX®, NetX™, NetX Duo™, USBX™, GUIX™, FileX®
  - Functional Libraries including Security & Encryption, CMSIS DSP, and Captouch
  - Application Framework, Hardware Abstraction Layer (HAL), and Board Support Package (BSP)
- Rich Application Framework to encapsulate many common functions such as security services, audio playback, power management, network messaging, JPEG conversion, and more
- Security & Encryption Library for Symmetric and Asymmetric crypto functions, HASH algorithms, secure key generation, storage, and more

## Synergy Microcontrollers

<b>S7</b> S7 Series High Performance	<b>S5</b> S5 Series High Integration	<b>S3</b> S3 Series High Efficiency	<b>S1</b> S1 Series Ultra Low Power
<ul style="list-style-type: none"> <li>• 240 MHz ARM® Cortex®-M4 CPU w/FPU</li> <li>• Up to 4 MB Code Flash</li> <li>• Up to 640 kB SRAM</li> <li>• Dual Ethernet MAC Controller w/PTP</li> <li>• USBHS and USBFS</li> <li>• CAN, SSI, QSPI, and SDHI</li> <li>• Graphics LCD Controller w/2D Drawing Engine</li> <li>• Capacitive Touch Sensing Unit</li> <li>• TRNG, Symmetric and Asymmetric Crypto, HASH</li> <li>• Integral Safety</li> </ul>	<ul style="list-style-type: none"> <li>• 120 MHz ARM® Cortex®-M4 CPU w/FPU</li> <li>• Up to 2 MB Code Flash</li> <li>• Up to 640 kB SRAM</li> <li>• Ethernet MAC Controller w/PTP</li> <li>• USBHS and USBFS</li> <li>• CAN, SSI, QSPI, and SDHI</li> <li>• Graphics LCD Controller w/2D Drawing Engine</li> <li>• Capacitive Touch Sensing Unit</li> <li>• TRNG, Symmetric and Asymmetric Crypto, HASH</li> <li>• Integral Safety</li> </ul>	<ul style="list-style-type: none"> <li>• 48 MHz ARM® Cortex®-M4 CPU w/FPU</li> <li>• Up to 1 MB Code Flash</li> <li>• Up to 192 kB SRAM</li> <li>• USBFS</li> <li>• CAN, SSI, QSPI, and SDHI</li> <li>• 14-bit A/D Converter and 12-bit D/A Converter</li> <li>• OPAMP</li> <li>• High-Speed and Low-Power Analog Comparators</li> <li>• Capacitive Touch Sensing Unit</li> <li>• TRNG, Crypto, HASH</li> <li>• Integral Safety</li> </ul>	<ul style="list-style-type: none"> <li>• 32 MHz ARM® Cortex®-M0+ CPU</li> <li>• Up to 128 kB Code Flash</li> <li>• Up to 16 kB SRAM</li> <li>• USBFS</li> <li>• CAN</li> <li>• 14-bit A/D Converter and 12-bit D/A Converter</li> <li>• Low-Power Analog Comparator</li> <li>• Capacitive Touch Sensing Unit</li> <li>• TRNG and AES</li> <li>• Integral Safety</li> </ul>

## Synergy Tools & Kits

- IAR Embedded Workbench for Renesas Synergy
  - IAR C compiler for ARM® C compiler
  - C-SPY® debugger
  - C-STAT® and C-RUN® code analytics tools
  - Support for IAR I-jet™ with power consumption analysis
- e<sup>2</sup> studio, an Integrated Solution Development Environment (ISDE)
  - GNU ARM® C compiler (IAR ARM® compiler option)
  - Smart Manual —Context-aware embedded documentation
- Common to IAR Embedded Workbench for Synergy and e<sup>2</sup> studio
  - Segger J-Link debugger
  - RTOS-aware debugging via J-Link® JTAG and Security Wire Debug (SWD)
  - TraceX® real time task monitoring for ThreadX®
- Project Generator to generate start-up code
- Pin, Clock, and Interrupt Configurator to generate start-up code
- GUIX™ Studio — Desktop graphical user interface design tool
- Kits
  - Starter Kits (SK) for low-cost introduction to using the entire Synergy Platform, with access to most Synergy MCU features and pins
  - Development Kits (DK) for full project development. Modular access to all Synergy MCU features and pins

## Synergy Solutions

- |  |   |
|--|---|
| <b>Product Example Kits (PE)</b> <ul style="list-style-type: none"> <li>• Human Machine Interface with brilliant color TFT-LCD and wired/wireless connectivity</li> <li>• Industrial data logger with precision analog and wireless</li> </ul> | <b>Application Example Kits (AE)</b> <ul style="list-style-type: none"> <li>• Capacitive touch evaluation modules</li> <li>• More to come for motor control, industrial networking, and mesh networked sensors</li> </ul> |
|--|---|

## Synergy Gallery

- Access Renesas Synergy Platform software and tools
- Browse and download Verified and Qualified Software Add-ons
- Generate a production license with a simple click



Accelerate. Innovate. Differentiate.

[www.renesas.com/synergy](http://www.renesas.com/synergy)

---

Before purchasing or using any Renesas Electronics products listed herein, please refer to the latest product manual and/or data sheet in advance.

**Renesas Electronics Europe**

**[www.renesas.com](http://www.renesas.com)**