

Contents

1. Internal Memory	4
1.1 Block Diagram.....	4
1.2 Offset.....	6
1.3 Slope.....	7
1.3.1. Slope of Transfer Function.....	7
1.3.2. Slope example.....	7
1.4 Clamping.....	8
1.4.1. Clamping Example.....	9
1.5 LinInt0.....	10
1.5.1. Linear Error Correction.....	10
1.6 LinInt1.....	11
1.7 LinInt2.....	12
1.8 LinInt3.....	13
1.9 LinInt4.....	14
1.10 Coil Offset.....	15
1.11 CalMode.....	16
1.11.1. Output Mode.....	17
1.11.2. Correction Mode.....	18
1.12 Output.....	19
1.13 Trimming.....	22
1.14 AGC0.....	23
1.15 AGC1.....	24
1.16 Mask.....	25
1.17 Traceability0.....	27
1.18 Traceability1.....	27
1.19 Misc.....	27
1.20 Afe_Agc.....	28
1.21 Xsine.....	28
1.22 Ycosine.....	29
1.23 Angle.....	29
1.24 Cordic Magnitude.....	30
1.25 SPA.....	30
1.26 Pos0.....	31
1.27 Pos1.....	31
2. Glossary	32
3. Revision History	32

List of Figures

Figure 1. Internal Memory of the ZMID4200	4
Figure 2. Internal Memory of the ZMID4200	7
Figure 3. Clamping Example	9
Figure 4. Linear Error Correction Example	10
Figure 5. Linear Output Mode Example with Slope = 2, Offset = 90°	17
Figure 6. Modulus Output Example with Slope = 2, Offset = 60°	17
Figure 7. Pre-Calibration Process	18
Figure 8. Post-Calibration Process	18
Figure 9. Output PWM Diagnostic Level	20
Figure 10. Output Analog Diagnostic Level	21
Figure 11. Gain Control	23

List of Tables

Table 1. Internal Memory	4
Table 2. Offset Register Description	6
Table 3. Offset Register Description Modulo 360	6
Table 4. Slope Register Description	7
Table 5. CLAMP Register Description	8
Table 6. LinInt0 Register Description	10
Table 7. LinInt1 Register Description	11
Table 8. LinInt2 Register Description	12
Table 9. LinInt3 Register Description	13
Table 10. LinInt4 Register Description	14
Table 11. Amplitude Offset Register Description	15
Table 12. CalMode Register Description	16
Table 13. Output Register Description	19
Table 14. Trim0 Register Description	22
Table 15. AGC0 Register Description	23
Table 16. AGC0 Register Description	24
Table 17. Mask Register Description	25
Table 18. Traceability0 Register Description	27
Table 19. Traceability1 Register Description	27
Table 20. Misc Register Description	27
Table 21. Afe_Agc Register Description	28
Table 22. Xsine Register Description	28
Table 23. Ycosine Register Description	29
Table 24. Angle Register Description	29
Table 25. Mag Register Description	30
Table 26. Spa Register Description	30

Table 27. Pos0 Register Description 31
Table 28. Pos1 Register Description 31

1. Internal Memory

1.1 Block Diagram

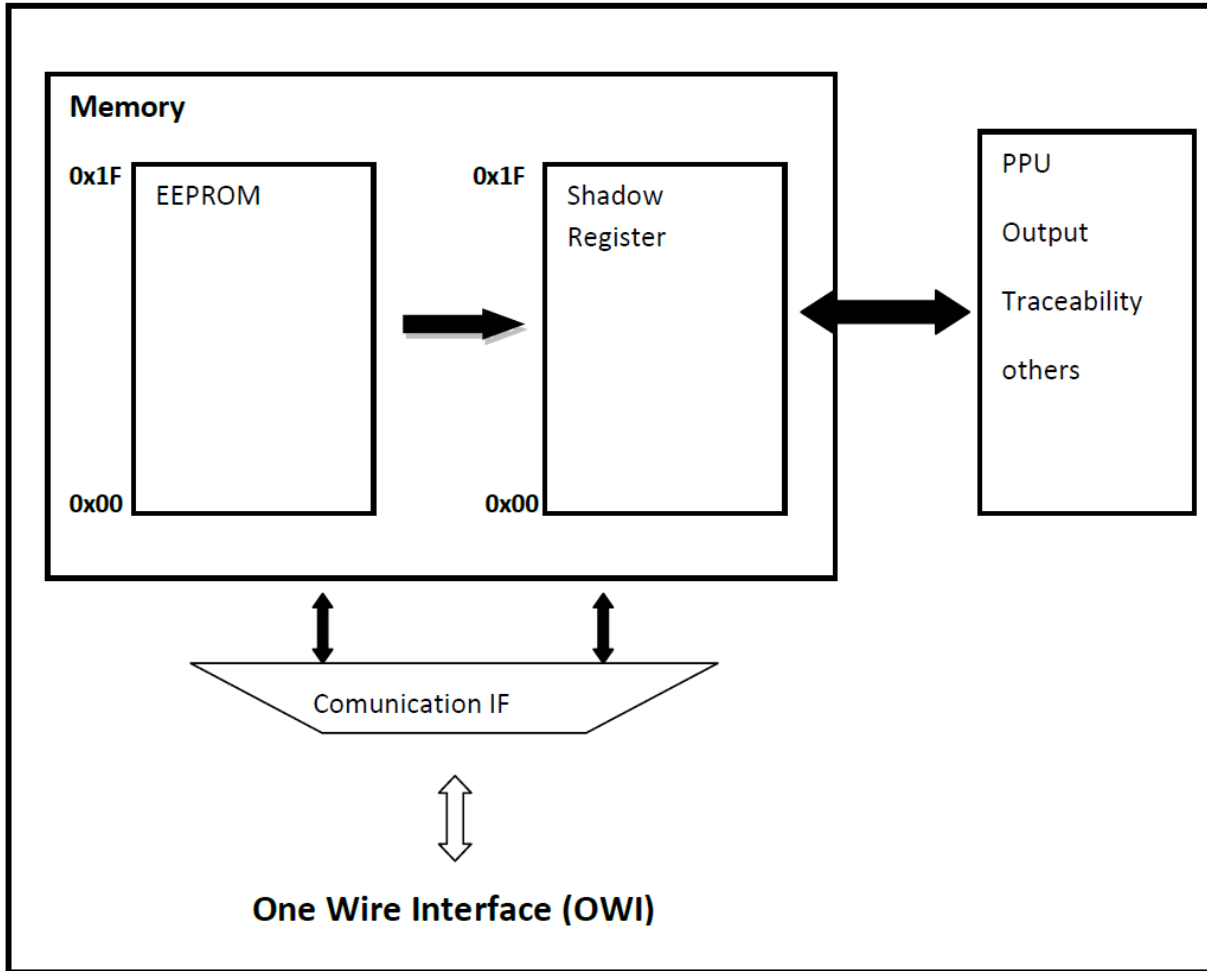

Figure 1. Internal Memory of the ZMID4200

Figure 1 shows the internal memory topology of the ZMID4200 products which is split up into a non-volatile EEPROM (E2P) and a volatile shadow ram (SWR) section. After chip start up the E2P content is copied into the SWR. During IC operation in OWI mode, changes in the SWR will take immediate effect whereas changes in the E2P require an IC power cycle. (Power off/Power on).

Definitions:

0b Binary number prefix.

0x Hexadecimal number prefix.

Table 1. Internal Memory

Address	Name	Type	Location	Function
0x00	Offset	R/W	E2P/SWR	14-bit zero- Zero Angle offset of output signal
0x01	Slope	R/W	E2P/ SWR	13-bit slope value of output signal
0x02	Clamping	R/W	E2P/SWR	Clamp values of output signal

Address	Name	Type	Location	Function
0x03	LinInt0	R/W	E2P/SWR	Linear interpolation of output signal corr1@12.5% (45°) - bit15...8 corr0@0%(0°) - bit7...0
0x04	LinInt1	R/W	E2P/SWR	Linear interpolation of output signal corr3@37.5% (135°) - bit15...8 corr2@25%(90°) - bit7...0
0x05	LinInt2	R/W	E2P/SWR	Linear interpolation of output signal corr5@62.5% (225°) - bit15...8 corr4@50%(180°) - bit7...0
0x06	LinInt3	R/W	E2P/SWR	Linear interpolation of output signal corr7@87.5% (315°) - bit15...8 corr6@75%(270°) - bit7...0
0x07	LinInt4	R/W	E2P/SWR	Linear interpolation of output signal not used - bit15...8 corr8@100%(360°) - bit7...0
0x08	Coil offset	R/W	E2P/SWR	Signal Offset correction of the demodulated input signals - sin and cos (r1,r2 - Ycos,Xsin); Only apply if constant input gain setting is activated.
0x09	CalMode	R/W	E2P/SWR	Calibration mode register contains control bits for output Mode like linear or modulo360 mode sensor; linear correction mode like pre-&post-calibration; Angle offset for linearity correction like 0° or -22.5°; Swap receiver coils polarity
0x0A	Output	R/W	E2P/SWR	Output register is used for configuration of the output SENT CRC, SENT Pause, PWM slope current, PWM freq, Analog diagnostic level.
0x0B	Trimming	R/W	E2P/SWR	This register contains control parameters for: PWM slope time, OSR, LC oscillator current, VDDT voltage calibration
0x0C	AGC0	R/W	E2P/SWR	Basic configurations of the analog front-end in terms of timing and gain e.g: Automated gain scheduling in number of samples; Integrator gain stage;
0x0D	AGC1	R/W	E2P/SWR	Configurations of excitation coil frequency limits (alarm setting); CORDIC magnitude limits; Interlink mode (integration time adaption and gain adaption)
0x0E	Mask	R/W	E2P/SWR	Diagnostic mask register is controlling which alarms are generating an output diagnostic flag e.g: Receiver coil1 open/short; Excitation coil break;
0x0F	Trace0	R/W	E2P	factory traceability code 0
0x10	Trace1	R/W	E2P	factory traceability code 1
0x11	Misc	R/W	E2P/SWR	Configuration of voltage regulators and oscillators; e.g. switch off VDDT regulator in case of excitation coil alarm
0x13	Afe_agc	R	SWR	Analog front-end/ Automatic gain regulation. Polarity of R1 & R2 ADC gain. AGC nr. of integration cycles
0x14	Xsine	R	SWR	13-bit Cordic raw input signal
0x15	Ycosine	R	SWR	13-bit Cordic raw input signal
0x16	Angle	R	SWR	15-bit Cordic output angle (0° to 90°)
0x17	Cordic Magnitude	R	SWR	15-bit Cordic output magnitude
0x18	Spa	R	SWR	Spatial angle 16-bit output angle (0° to 360°) before output calibration and linear error correction.
0x19	Pos0	R	SWR	Position0 16-bit output angle (0° to 360°) after output calibration; If linearization done before output calibration this value = Position1; If linearization done after output calibration this value ≠ Position1
0x1A	Pos1	R	SWR	Position1 16-bit output angle (0° to 360°) after output calibration and linearization; This value is always affected by

1.2 Offset

Address of register: 0x00.

Default value: 0x0000.

The offset parameter is used for the calibration of the position transfer function. The notation of the offset parameter depends on the output mode (see 1.12). Two output modes can be selected (modulo360 or linear).

Output mode: Modulo360 (set out_mod = 0b1 (1.10), for selecting the output mode “360Modulo”)

Table 2. Offset Register Description

Bits	Symbol	Description																				
Off.15 - Off.14	Reserved	Not used, read as 0 (SWR).																				
Off.13 - Off.0	Offset	Offset of output transfer function.																				
		<table border="1"> <thead> <tr> <th>Offset Value</th> <th>Value in Degree</th> </tr> </thead> <tbody> <tr><td>0x0000</td><td>0</td></tr> <tr><td>0x0800</td><td>45</td></tr> <tr><td>0x1000</td><td>90</td></tr> <tr><td>0x1800</td><td>135</td></tr> <tr><td>0x2000</td><td>180</td></tr> <tr><td>0x2800</td><td>225</td></tr> <tr><td>0x3000</td><td>270</td></tr> <tr><td>0x3800</td><td>315</td></tr> <tr><td>0x3FFF</td><td>360</td></tr> </tbody> </table>	Offset Value	Value in Degree	0x0000	0	0x0800	45	0x1000	90	0x1800	135	0x2000	180	0x2800	225	0x3000	270	0x3800	315	0x3FFF	360
		Offset Value	Value in Degree																			
		0x0000	0																			
		0x0800	45																			
		0x1000	90																			
		0x1800	135																			
		0x2000	180																			
		0x2800	225																			
		0x3000	270																			
		0x3800	315																			
0x3FFF	360																					

Note: The reserved bits off.15 & off.14 can be written and read to/from the block E2P. The copy process copies only bits (off.13 down to off.0) to the SWR.

Output mode: Linear (set out_mod = 0b0 (see section 1.11.1), for selecting Linear Output mode).

Table 3. Offset Register Description Modulo 360

Bits	Symbol	Description																																						
Off.15 - Off.14	Reserved	Not used, read as 0 (SWR).																																						
Off.13 - Off.0	Offset	Offset of output transfer function.																																						
		<table border="1"> <thead> <tr> <th>Offset Value</th> <th>Value in Degree</th> </tr> </thead> <tbody> <tr><td>0x0000</td><td>180</td></tr> <tr><td>0x0400</td><td>360</td></tr> <tr><td>0x0800</td><td>540</td></tr> <tr><td>0x0C00</td><td>720</td></tr> <tr><td>0x1000</td><td>900</td></tr> <tr><td>0x1400</td><td>1080</td></tr> <tr><td>0x1800</td><td>1260</td></tr> <tr><td>0x1C00</td><td>1440</td></tr> <tr><td>0x1FFF</td><td>1620</td></tr> <tr><td>0x2000</td><td>180</td></tr> <tr><td>0x2400</td><td>0</td></tr> <tr><td>0x2800</td><td>-180</td></tr> <tr><td>0x2C00</td><td>-360</td></tr> <tr><td>0x3000</td><td>-540</td></tr> <tr><td>0x3400</td><td>-720</td></tr> <tr><td>0x3800</td><td>-900</td></tr> <tr><td>0x3C00</td><td>-1080</td></tr> <tr><td>0x3FFF</td><td>-1260</td></tr> </tbody> </table>	Offset Value	Value in Degree	0x0000	180	0x0400	360	0x0800	540	0x0C00	720	0x1000	900	0x1400	1080	0x1800	1260	0x1C00	1440	0x1FFF	1620	0x2000	180	0x2400	0	0x2800	-180	0x2C00	-360	0x3000	-540	0x3400	-720	0x3800	-900	0x3C00	-1080	0x3FFF	-1260
		Offset Value	Value in Degree																																					
		0x0000	180																																					
		0x0400	360																																					
		0x0800	540																																					
		0x0C00	720																																					
		0x1000	900																																					
		0x1400	1080																																					
		0x1800	1260																																					
		0x1C00	1440																																					
		0x1FFF	1620																																					
		0x2000	180																																					
		0x2400	0																																					
		0x2800	-180																																					
		0x2C00	-360																																					
		0x3000	-540																																					
		0x3400	-720																																					
		0x3800	-900																																					
		0x3C00	-1080																																					
		0x3FFF	-1260																																					

Note: The reserved bits off.15 & off.14 can be written and read to/from the block E2P. The copy process copies only bits (off.13 down to off.0) to the SWR.

1.3 Slope

Address of register: 0x01.

Default value: 0x0400.

1.3.1. Slope of Transfer Function

The slope parameter is used for the calibration of the position transfer function. It is a multiplication factor for the spatial angle. The slope notation is independent from the out_mode parameter (see section 1.12).

Table 4. Slope Register Description

Bits	Symbol	Description																																		
slp.15 - slp.13	Reserved	Not used, read as 0 (SWR)																																		
slp.12 - slp.0	Slope	Slope of output transfer function.																																		
		<table border="1"> <thead> <tr> <th>Offset Value</th> <th>Value in Degree</th> </tr> </thead> <tbody> <tr><td>0x0000</td><td>0.0</td></tr> <tr><td>0x0100</td><td>0.25</td></tr> <tr><td>0x0200</td><td>0.5</td></tr> <tr><td>0x0300</td><td>0.75</td></tr> <tr><td>0x0400</td><td>1.0</td></tr> <tr><td>0x0800</td><td>2.0</td></tr> <tr><td>0x0C00</td><td>3.0</td></tr> <tr><td>0x0FFF</td><td>3.999</td></tr> <tr><td>0x1000</td><td>-0.0</td></tr> <tr><td>0x1100</td><td>-0.25</td></tr> <tr><td>0x1200</td><td>0.5</td></tr> <tr><td>0x1300</td><td>0.75</td></tr> <tr><td>0x1400</td><td>-1.0</td></tr> <tr><td>0x1800</td><td>-2.0</td></tr> <tr><td>0x1C00</td><td>-3.0</td></tr> <tr><td>0x1FFF</td><td>-3.999</td></tr> </tbody> </table>	Offset Value	Value in Degree	0x0000	0.0	0x0100	0.25	0x0200	0.5	0x0300	0.75	0x0400	1.0	0x0800	2.0	0x0C00	3.0	0x0FFF	3.999	0x1000	-0.0	0x1100	-0.25	0x1200	0.5	0x1300	0.75	0x1400	-1.0	0x1800	-2.0	0x1C00	-3.0	0x1FFF	-3.999
Offset Value	Value in Degree																																			
0x0000	0.0																																			
0x0100	0.25																																			
0x0200	0.5																																			
0x0300	0.75																																			
0x0400	1.0																																			
0x0800	2.0																																			
0x0C00	3.0																																			
0x0FFF	3.999																																			
0x1000	-0.0																																			
0x1100	-0.25																																			
0x1200	0.5																																			
0x1300	0.75																																			
0x1400	-1.0																																			
0x1800	-2.0																																			
0x1C00	-3.0																																			
0x1FFF	-3.999																																			

Note: The reserved bits slp.15, slp.14 and slp.13 can be written and read to/from the block E2P.

1.3.2. Slope example

Slope value coded on 13bits with a range between -4 to +4, 1 bit is the sign and defines the sign of (slope).

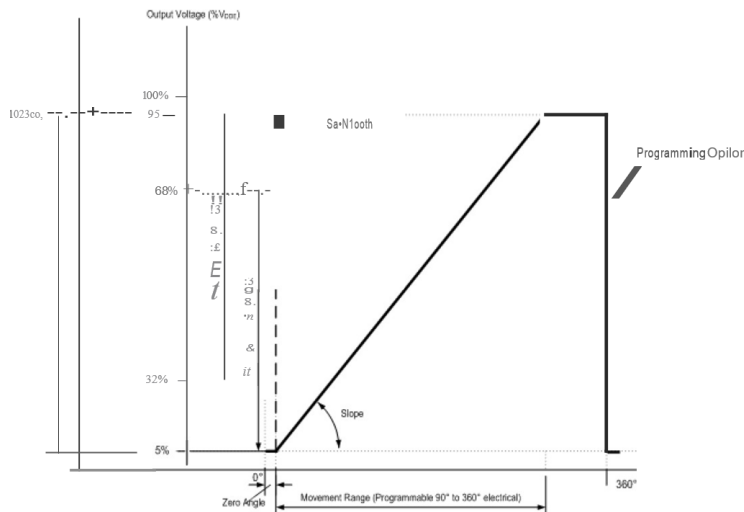

Figure 2. Internal Memory of the ZMID4200

Figure 2 shows the internal memory topology of the ZMID4200 products which is split up into a non-volatile EEPROM (E2P) and a volatile shadow ram (SWR) section. After chip start up the E2P content is copied into the SWR. During IC operation in OWI mode, changes in the SWR will take immediate effect whereas changes in the E2P require an IC power cycle. (Power off/Power on).

1.4 Clamping

Address of register: 0x02.

Default value: 0x0000.

The clamping parameters clamp_low and clamp_high are located in the clamp memory. These two parameters are used for position calibration if the output protocol mode is for ZMID4200. For the Analog output mode the complete 100% position range is mapped to a voltage range from 250mV to 4750mV. The stepping rate of the clamping parameters is 1%, so that the analog voltage stepping rate is 47.5 mV / 1 %. The diagnostic low level is less or equal 200mV, the high level is higher or equal 4800mV.

For the PWM output mode the position range is mapped to the Pulse Pause Ratio (PPR) of a periodic analog output signal. 100% position range is mapped to the PPR-range from 5% to 95%. So a clamping step of 1% is mapped to a PPR change of 0.9% (e.g. clamp_low = 10% & pos <= clamp_low --> PPR = 5% + 9%). The diagnostic low level is mapped to 2.5% PPR, the high level is mapped to 97.5% PPR.

Table 5. CLAMP Register Description

Bits	Symbol	Description	
clamp. 15 - clamp. 14	Reserved	Not used, read as 0 (SWR)	
clamp. 13 - clamp. 8	clamp_high	Position output clamp high descend from 4750 mV (Analog) resp. 95% (PWM).	
		clamp_high (CLAMP13 - CLAMP08)	Rate (%)
		0x00	0
		0x01	1
		0x02	2
	
	
	
	
		0x3F	63
clamp. 7 - clamp.6	Reserved	Not used, read as 0 (SWR)	
clamp. 5 - clamp. 0	clamp_low	Position output clamp low rising from 250mV (Analog) resp. 5% (PWM)	
		clamp_low (CLAMP5 - CLAMP00)	Rate (%)
		0x00	0
		0x01	1
		0x02	2
	
	
	
	
		0x3F	63

Note: The reserved bits clamp.15, clamp.14, clamp.7 and clamp.6 can be written and read to/from the block E2P. The copy process copies only bits (clamp.13 down to clamp.8) and (clamp.5 down to clamp.0) to the SWR.

1.4.1. Clamping Example

Clamps (applicable for Analog and PWM Output, not for SENT).

Clamp_low (6 bits): min value is 5%, steps of 1% from minimum value. Max Clamp_low value is: 68%.

Clamp_high (6 bits): max value is 95%, steps of -1% from max value. Min Clamp_high value is: 32%.

In the below example the clamping levels are 5% and 95%.

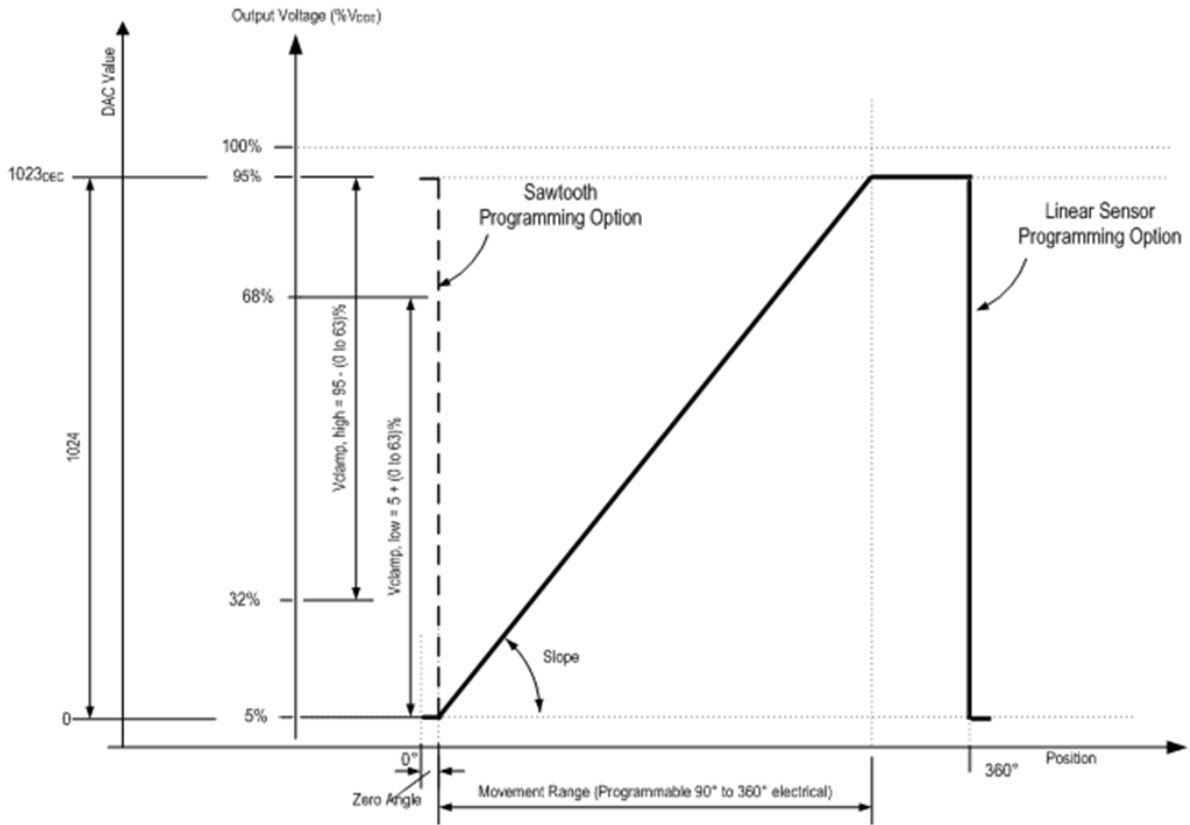

Figure 3. Clamping Example

1.5 LinInt0

Address of register: 0x03.

Default value: 0x0000.

The linearity of the position transfer function can be modified by a 9-point correction curve over the whole position range. The correction curve is defined by 9 points: corr0....corr8. The correction factor can be calculated by a linear interpolation over the 9 corresponding points. The correction factor is applied on the 11 most significant position bits.

Table 6. LinInt0 Register Description

Bits	Symbol	Description	
linint0.15 - linint0.8	corr1	Correction factor 1 for position 12.5% (45 deg).	
		Corr0 (linint7 - linint0)	Correction Factor
		0x00	0
		0x01	1
	
	
	
		0x7F	127
		0x10	-0
		0x11	-1
	
	
	
0xFF	-127		
Linint0.7 - linint0.0	corr0	Correction factor 0 for position 0% (0 deg)	
		Corr0 (linint7 - linint0)	Correction Factor
		0x00	0
		0x01	1
	
	
	
		0x7F	127
		0x10	-0
		0x11	-1
	
	
	
0xFF	-127		

Note: The notation of the correction factor is sign & abs. with a range of +127...+0.....-127.

1.5.1. Linear Error Correction

The linear error correction function has 9 equidistant fixed correction points (one dimensional). Between each pair of grid points a linear interpolation function evaluates the correction factor.

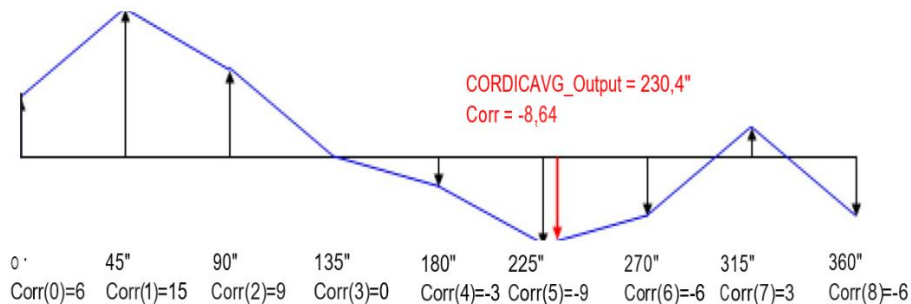

Figure 4. Linear Error Correction Example

1.6 LinInt1

Address of register: 0x04.

Default value: 0x0000.

The linearity of the position transfer function can be modified by a correction curve over the whole position range. The correction curve is defined by 9 points: corr0....corr8. The correction factor can be calculated by a linear interpolation over the 9 corresponding points. The correction factor is applied on the 11 most significant position bits.

Table 7. LinInt1 Register Description

Bits	Symbol	Description	
Linint1.15 - linint1.8	Corr3	Correction factor 3 for position 37.5% (135 deg).	
		Corr3 (linint15 - linint8)	Correction Factor
		0x00	0
		0x01	1
	
	
	
		0x7F	127
		0x10	-0
		0x11	-1
	
	
	
		0xFF	-127
Linint1.7 - linint1.0	Corr2	Correction factor 2 for position 25% (90 deg).	
		Corr2 (linint7 - linint0)	Correction Factor
		0x00	0
		0x01	1
	
	
	
		0x7F	127
		0x10	-0
		0x11	-1
	
	
	
		0xFF	-127

Note: The notation of the correction factor is sign & abs. with a range of +127...+ 0.....-127.

1.7 LinInt2

Address of register: 0x05.

Default value: 0x0000.

The linearity of the position transfer function can be modified by a correction curve over the whole position range. The correction curve is defined by 9 points: corr0....corr8. The correction factor can be calculated by a linear interpolation over the 9 corresponding points. The correction factor is applied on the 11 most significant position bits.

Table 8. LinInt2 Register Description

Bits	Symbol	Description	
Linint2.15 - linint2.8	Corr5	Correction factor 5 for position 62.5% (225 deg).	
		Corr5 (linint15 - linint8)	
		0x00	0
		0x01	1
	
	
	
		0x7F	127
		0x10	-0
		0x11	...
	
	
		0xFF	-127
Linint2.7 - linint2.0	Corr4	Correction factor 4 for position 50% (180 deg).	
		Corr4 (linint7 - linint0)	
		0x00	0
		0x01	1
	
	
	
		0x7F	127
		0x10	-0
		0x11	...
	
	
		0xFF	-127

Note: The notation of the correction factor is sign & abs. with a range of +127 ... +- 0.....-127.

1.8 LinInt3

Address of register: 0x06.

Default value: 0x0000.

The linearity of the position transfer function can be modified by a correction curve over the whole position range. The correction curve is defined by 9 points: corr0....corr8. The correction factor can be calculated by a linear interpolation over the 9 corresponding points. The correction factor is applied on the 11 most significant position bits.

Table 9. LinInt3 Register Description

Bits	Symbol	Description	
Linint3.15 - linint3.8	Corr7	Correction factor 7 for position 87.5% (315deg).	
		Corr7 (linint3.15 - linint3.8)	Correction Factor
		0x00	0
		0x01	1
	
	
	
		0x7F	127
		0x10	-0
		0x11	-1
	
	
	
		0xFF	-127
Linint3.7 - linint3.0	Corr6	Correction factor 6 for position 75% (270deg).	
		Corr6 (linint3.7 - linint3.0)	Correction Factor
		0x00	0
		0x01	1
	
	
	
		0x7F	127
		0x10	-0
		0x11	-1
	
	
	
		0xFF	-127

Note: The notation of the correction factor is sign & abs. with a range of +127 ... +- 0..... -127.

1.9 LinInt4

Address of register: 0x07.

Default value: 0x0000.

The linearity of the position transfer function can be modified by a correction curve over the whole position range. The correction curve is defined by 9 points: corr0....corr8. The correction factor can be calculated by a linear interpolation over the 9 corresponding points. The correction factor is applied on the 11 most significant position bits.

Table 10. LinInt4 Register Description

Bits	Symbol	Description	
Linint4.15 - linint4.8	Reserved	Not used, read as 0 (SWR)	
Linint4.7 - linint4.0	Corr8	Correction factor 8 for position 100% (360deg)	
		Corr8 (linint4.15 - linint4.8)	Correction Factor
		0x00	0
		0x01	1
	
	
	
		0x7F	127
		0x10	-0
		0x11	-1
	
	
	
0xFF	-127		

Note: The notation of the correction factor is sign & abs. with a range of +127 ...+0.....-127.

1.10 Coil Offset

Address of register: 0x08.

Default value: 0x0000.

The defined register offset values are added/ subtracted to/from the amplitude values (13-bit) of the receiver coil R2 and coil R1 values. When using the signal offset compensation the automated gain control (AGC1) must be switched off. (agc_mode = 0b00 => Automatic gain OFF, integration time adaption OFF).

Table 11. Amplitude Offset Register Description

Bits	Symbol	Description		
amp.15	mult_r1	Multiplication factor for amplitude offset_r1		
		mult_r1 (amp.15)	Multiplication Factor	
		0b0	2	
		0b1	4	
amp.14 - amp.8	offset_r1	Offset value which is added/subtracted to/from receiver coil R1 amplitude		
		mult_r1	offset_r1	Correction Factor (Decimal)
		0b0	0b0111111	Ycosine + 126
			0b0000000	Ycosine + 0
			0b1000000	Ycosine - 0
			0b1111111	Ycosine - 126
		0b1	0b0111111	Ycosine + 252
			0b0000000	Ycosine + 0
			0b1000000	Ycosine - 0
			0b1111111	Ycosine - 252
amp.7	mult_r2	Multiplication factor for offset_r2		
		mult_r2 (amp.7)	Multiplication Factor	
		0b0	2	
		0b1	4	
amp.6 - amp.0	offset_r2	Offset value which is added/subtracted to/from receiver coil R2 amplitude.		
		mult_r2	offset_r2	Correction Factor (Decimal)
		0b0	0b0111111	Xsine + 126
			0b0000000	Xsine + 0
			0b1000000	Xsine - 0
			0b1111111	Xsine - 126
		0b1	0b0111111	Xsine + 252
			0b0000000	Xsine + 0
			0b1000000	Xsine - 0
			0b1111111	Xsine - 252

Note: abs (Xsine + offset_r2) exceeds max.value of 0x1FFF → amplitude DSP overflow alarm is asserted.

1.11 CalMode

Address of register: 0x09.

Default value: 0x0000.

The calibration mode register contains some control bits which configure the calibration mode and evaluation of the correction curve.

Table 12. CalMode Register Description

Bits	Symbol	Description	
calmod.15 - calmod.13	Reserved	Not used, read as 0 (SWR)	
calmod.12	out_mod	Output Mode	
		Out_mod	Output Mode
		0b0	Linear
		0b1	Modulo360
calmod.11 – calmod.9	Reserved	Not used, read as 0 (SWR)	
calmod.8	corr_mod	Correction Mode. Defines how the correction curve has to be applied to correct the linearity of the output transfer function.	
		Corr_mod	Correction Mode
		0b0	Linear error correction pre-calibration
		0b1	Linear error correction post-calibration
calmod.7 – calmod.5	Reserved	Not used, read as 0 (SWR)	
calmod.4	angle_offset	Linearization angle offset. If (angle_offset) = 1, -22,5° offset is added to the CORDIC calculation only in the case of an Interpolation correction before the Slope calibration (Corr_MOD) = 0	
		Angle_offset	Angle Offset in Degree
		0b0	0
		0b1	-22.5
calmod.3	swap_rc_pol	Testing bits for Renesas	
calmod.2	swap_rc_amp	Testing bits for Renesas	
calmod.1	invppr2	Testing bits for Renesas	
calmod.0	invppr1	Testing bits for Renesas	

1.11.1. Output Mode

Linear (Out_Mod = 0): Linear Output Mode is a non-repeating output mode in which the sensor output signal is clamped at the mechanical end points with a range of -1260° ... + 1620°.

Modulo 360 (Out_Mod = 1): The Modulo 360 Output (Sawtooth Output) Mode is a repeating output mode in which the sensor output signal is not clamped at the mechanical end points, but is switched back to its origin with a range between 0° to 360°.

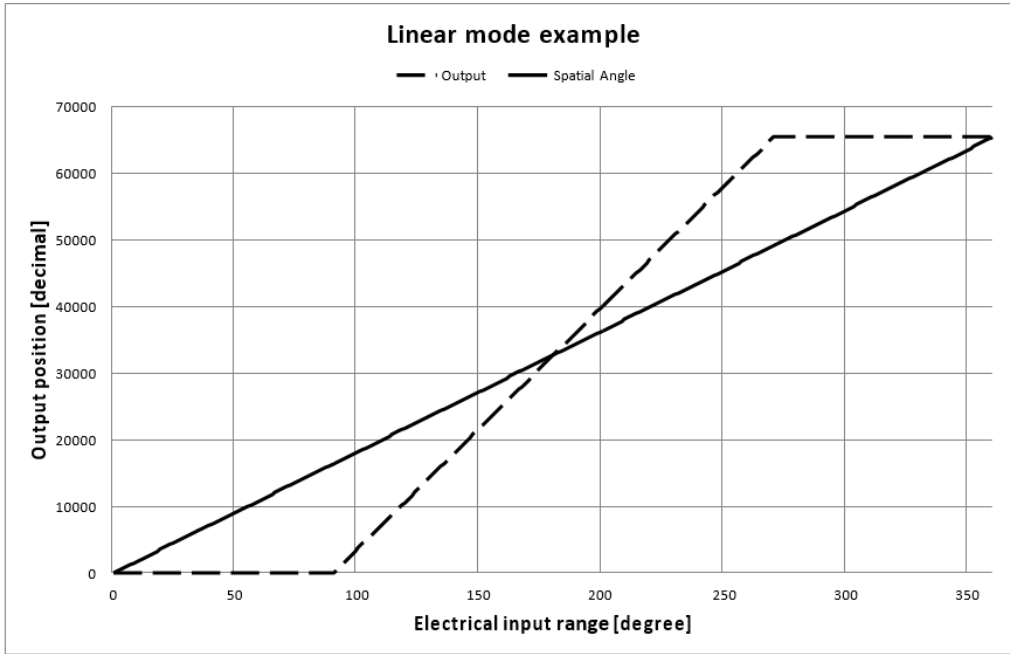

Figure 5. Linear Output Mode Example with Slope = 2, Offset = 90°

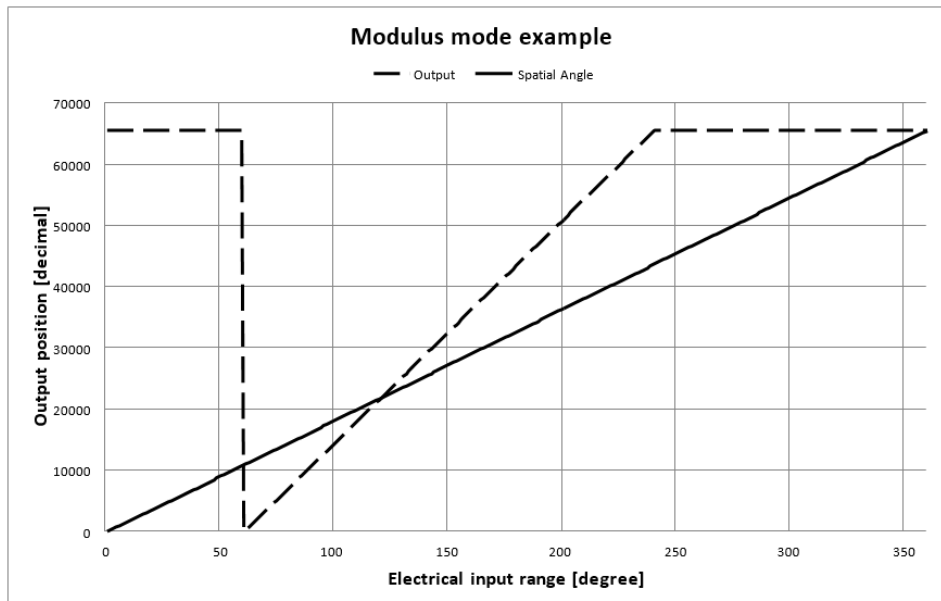

Figure 6. Modulus Output Example with Slope = 2, Offset = 60°

1.11.2. Correction Mode

Pre Calibration: if (Corr_MOD) = 0 then linearity correction is done before "Slope & Offset".

The pre-calibration should be used if the electric input covers a range of a 360°. Using pre-calibration is an advantage when slope and offset needs to be changed after linearization.

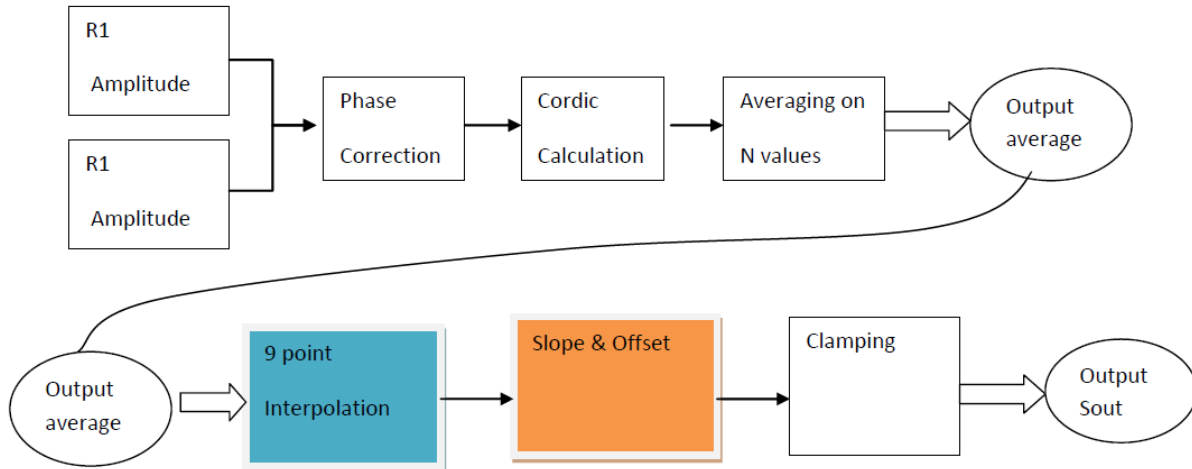

Figure 7. Pre-Calibration Process

Post Calibration; if (Corr_MOD) = 1 then linearity correction is done after " Slope & Offset ". The post-calibration should be the default standard type of calibration.

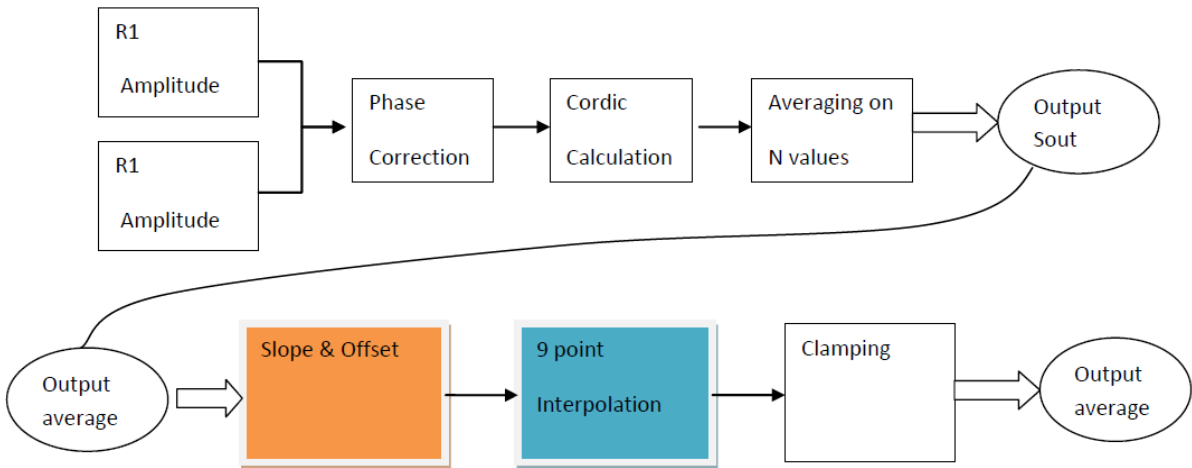

Figure 8. Post-Calibration Process

Note: The reserved bits can be written and read to/from the block E2P. The copy process copies only bits (calmod.12, calmod.8, calmod.4, calout1 and calmod.0) to the SWR.

Note: Individual swapping of receiver polarity & amplitude is only for testing purpose. For application mode both control bits have to be set 0b1 respectively 0b0.

1.12 Output

Address of register: 0x0A Default value: 0x0802

The output register configuration.

Table 13. Output Register Description

Bits	Symbol	Description																		
output.15	Reserved	Not used, read as 0 (SWR)																		
output.14	sent_crc	<p>Only for SENT output SENT CRC The SENT CRC bit switched between CRC calculation according Legacy implementation of SAE J 2716.</p> <table border="1"> <thead> <tr> <th>SENT CRC</th> <th>CRC Calculation</th> </tr> </thead> <tbody> <tr> <td>0b0</td> <td>CRC calculation according rev. Feb 2008</td> </tr> <tr> <td>0b1</td> <td>CRC calculation according SAE J 2716, Rev 3</td> </tr> </tbody> </table>	SENT CRC	CRC Calculation	0b0	CRC calculation according rev. Feb 2008	0b1	CRC calculation according SAE J 2716, Rev 3												
SENT CRC	CRC Calculation																			
0b0	CRC calculation according rev. Feb 2008																			
0b1	CRC calculation according SAE J 2716, Rev 3																			
output.13	sent_pause	<p>Only for SENT output SENT Pause The sent pause bit switches between a constant SENT frame length according SAE J 2716 rev3 by including a pause pulse and a variable SENR frame length according rev2.</p> <table border="1"> <thead> <tr> <th>Sent_pause</th> <th>Frame Length</th> </tr> </thead> <tbody> <tr> <td>0b0</td> <td>SENT frame according to SAE J 2716 Rev.2</td> </tr> <tr> <td>0b1</td> <td>SENT frame length according SAE J 2716, Rev3.</td> </tr> </tbody> </table>	Sent_pause	Frame Length	0b0	SENT frame according to SAE J 2716 Rev.2	0b1	SENT frame length according SAE J 2716, Rev3.												
Sent_pause	Frame Length																			
0b0	SENT frame according to SAE J 2716 Rev.2																			
0b1	SENT frame length according SAE J 2716, Rev3.																			
output.12	sent_ssn	<p>Only for SENT output: SENT SSN The sensor payload is transferred by the 3 data nibbles of signal1. The payload structure of signal2 depends on the SENT single secure nibble bit.</p> <table border="1"> <thead> <tr> <th>SENT SSN</th> <th>Frame Length</th> </tr> </thead> <tbody> <tr> <td>0b0</td> <td>nibble #4, #5, #6 set to zero</td> </tr> <tr> <td>0b1</td> <td>nibble #4 & nibble #5 = value of 8-bit rolling counter with rollover back to zero.nibble #6 = inverted copy of nibble #1.</td> </tr> </tbody> </table>	SENT SSN	Frame Length	0b0	nibble #4, #5, #6 set to zero	0b1	nibble #4 & nibble #5 = value of 8-bit rolling counter with rollover back to zero.nibble #6 = inverted copy of nibble #1.												
SENT SSN	Frame Length																			
0b0	nibble #4, #5, #6 set to zero																			
0b1	nibble #4 & nibble #5 = value of 8-bit rolling counter with rollover back to zero.nibble #6 = inverted copy of nibble #1.																			
output.11 - output.8	pwm_slope_curr	<p>Only for PWM output PWM slope current The fall time of the PWM output signal is controlled by several current sources related to a master current source. The current of the master source can be programmed.</p> <table border="1"> <thead> <tr> <th>Pwm_slope_curr</th> <th>PWM Slope Current</th> </tr> </thead> <tbody> <tr> <td>0x0</td> <td>Minimum</td> </tr> <tr> <td>0xF</td> <td>Maximum</td> </tr> </tbody> </table>	Pwm_slope_curr	PWM Slope Current	0x0	Minimum	0xF	Maximum												
Pwm_slope_curr	PWM Slope Current																			
0x0	Minimum																			
0xF	Maximum																			
output.7	Reserved	Not used, read as 0 (SWR)																		
output.6 - output.4	pwm_freq	<p>Only for PWM output PWM frequency</p> <table border="1"> <thead> <tr> <th>Pwm_freq</th> <th>PWM Frequency (Hz)</th> </tr> </thead> <tbody> <tr> <td>0b000</td> <td>2023</td> </tr> <tr> <td>0b001</td> <td>1517</td> </tr> <tr> <td>0b010</td> <td>1214</td> </tr> <tr> <td>0b011</td> <td>1011</td> </tr> <tr> <td>0b100</td> <td>758</td> </tr> <tr> <td>0b101</td> <td>506</td> </tr> <tr> <td>0b110</td> <td>253</td> </tr> <tr> <td>0b111</td> <td>126</td> </tr> </tbody> </table>	Pwm_freq	PWM Frequency (Hz)	0b000	2023	0b001	1517	0b010	1214	0b011	1011	0b100	758	0b101	506	0b110	253	0b111	126
Pwm_freq	PWM Frequency (Hz)																			
0b000	2023																			
0b001	1517																			
0b010	1214																			
0b011	1011																			
0b100	758																			
0b101	506																			
0b110	253																			
0b111	126																			
output.3	pwm_diag	<p>Only for PWM output PWM diagnostic level The output protocol PWM allows two PPR for the diagnostic flag: diagnostic low & diagnostic high. Bit output.3 allows to select one of the two levels if diagnostic alarm is asserted.</p>																		
output.2	ana_diag	<p>Only for Analog output ANALOG diagnostic level The output protocol ANALOG allows two voltage ranges for the diagnostic flag: diagnostic low & diagnostic high. bit output.2 allows to select one of the two levels if diagnostic alarm is asserted.</p>																		

Bits	Symbol	Description										
output.1- output.0	out_pro	Output interface: These bits are used to configure the output interface. The default output is analog.										
		<table border="1"> <thead> <tr> <th>out_pro</th> <th>Outputs</th> </tr> </thead> <tbody> <tr> <td>0b00</td> <td>OWI</td> </tr> <tr> <td>0b01</td> <td>PWM</td> </tr> <tr> <td>0b10</td> <td>Analog output voltage (default)</td> </tr> <tr> <td>0b11</td> <td>SENT</td> </tr> </tbody> </table>	out_pro	Outputs	0b00	OWI	0b01	PWM	0b10	Analog output voltage (default)	0b11	SENT
out_pro	Outputs											
0b00	OWI											
0b01	PWM											
0b10	Analog output voltage (default)											
0b11	SENT											

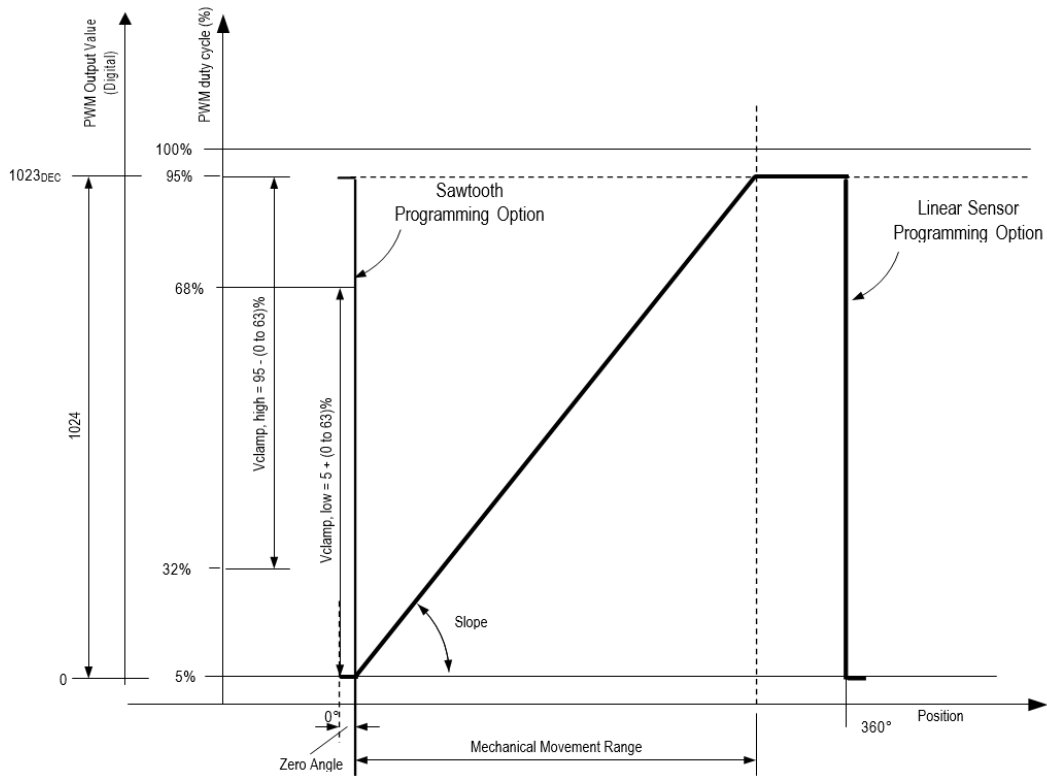

Figure 9. Output PWM Diagnostic Level

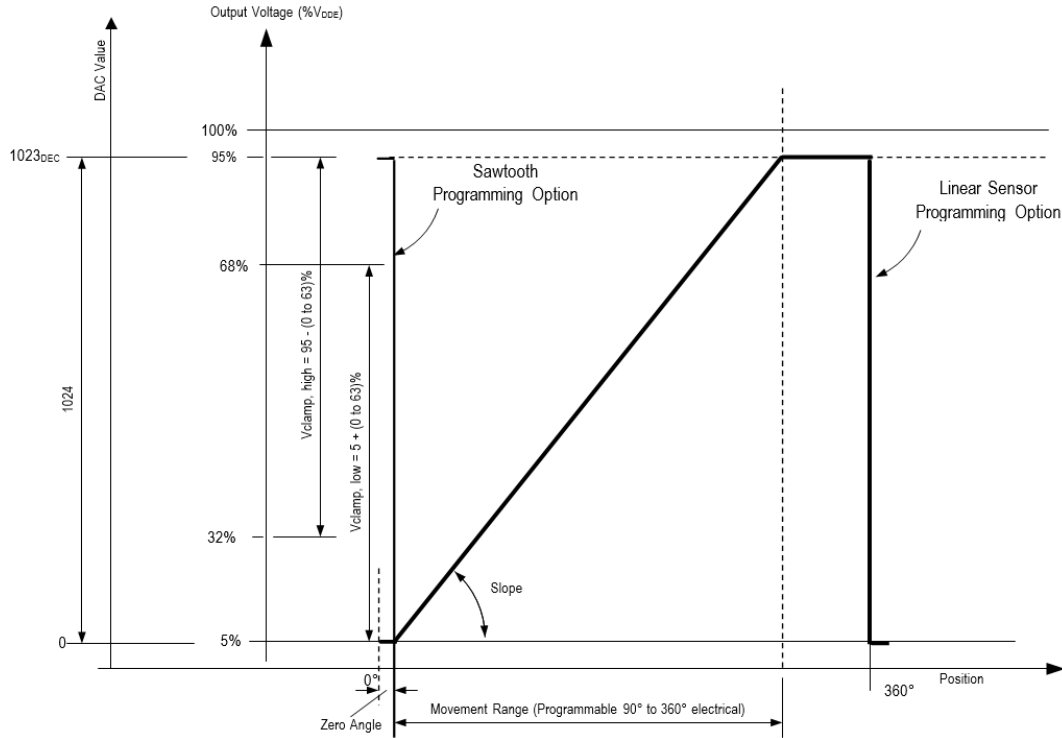

Figure 10. Output Analog Diagnostic Level

Note: The reserved bits can be written and read to/from the block E2P. The copy process copies only defined bits to the SWR.

Note: PWM & SENT timing parameters are based on the ZMID4200 internal oscillator period. To fulfill the electrical specification the oscillator has to be calibrated to 16MHz (see 1.14).

1.13 Trimming

Address of register: 0x0B Default value: 0x8107

Trimming and OSR

The Trimming parameters controls the I_c current and the vddt voltage regulator. The OSR parameter defines the decimation of ADC samples for calculating the position processing update rate.

Table 14. Trim0 Register Description

Bits	Symbol	Description										
trim0.15 - trim0.14	pwm_slope_time	<p>PWM slope time</p> <p>The fall time of the PWM output signal is controlled by current sources. The current sources are switched on in 5 consecutive steps. The time between the steps is defined by the pwm_slope_time parameter.</p> <p>pwm_slope_time= 0b00. 435ns / step pwm_slope_time= 0b01.580ns / step</p>										
trim0.13 - trim0.12	osr	<p>Oversampling Rate</p> <p>The oversampling rate defines the number of samples per receive channel which are accumulated and used for the PPU.</p> <table border="1"> <thead> <tr> <th>OSR</th> <th>Samples/Channel</th> </tr> </thead> <tbody> <tr> <td>0b00</td> <td>4</td> </tr> <tr> <td>0b01</td> <td>8</td> </tr> <tr> <td>0b10</td> <td>16</td> </tr> <tr> <td>0b11</td> <td>32</td> </tr> </tbody> </table>	OSR	Samples/Channel	0b00	4	0b01	8	0b10	16	0b11	32
OSR	Samples/Channel											
0b00	4											
0b01	8											
0b10	16											
0b11	32											
trim0.11 - trim0.9	Reserved	Not used, read as 0 (SWR)										
trim0.8 - trim0.4	lc_cal	<p>LC Oscillator Calibration (excitation coil)</p> <table border="1"> <thead> <tr> <th>lc_cal</th> <th>Current (Excitation Coil)</th> </tr> </thead> <tbody> <tr> <td>0b0.0000</td> <td>Min (0 mA)</td> </tr> <tr> <td>0b1.1111</td> <td>Max (15 mA)</td> </tr> </tbody> </table>	lc_cal	Current (Excitation Coil)	0b0.0000	Min (0 mA)	0b1.1111	Max (15 mA)				
lc_cal	Current (Excitation Coil)											
0b0.0000	Min (0 mA)											
0b1.1111	Max (15 mA)											
trim0.3	Reserved	Not used, read as 0 (SWR)										
trim0.2 - trim0.0	vddt_trim	Renesas internal parameter for testing										

1.15 AGC1

Address of register: 0x0D Default value: 0x0255.

Automatic Gain Control.

Table 16. AGC0 Register Description

Bits	Symbol	Description																		
agc1.15	agc_suppress	Renesas internal																		
agc1.14	agc_interlink	Renesas internal																		
agc1.13 - agc1.12	agc_mode	Extend integration cycle related to excitation clock period effective integration time = (7 + ext) x lc_period. <table border="1"> <thead> <tr> <th>Agc_mode</th> <th>Automatic Gain</th> <th>Integration Gain Adaptation</th> </tr> </thead> <tbody> <tr> <td>0b00</td> <td>Off</td> <td>Off</td> </tr> <tr> <td>0b01</td> <td>Off</td> <td>On</td> </tr> <tr> <td>0b10</td> <td>On</td> <td>Off</td> </tr> <tr> <td>0b11</td> <td>On</td> <td>On</td> </tr> </tbody> </table>	Agc_mode	Automatic Gain	Integration Gain Adaptation	0b00	Off	Off	0b01	Off	On	0b10	On	Off	0b11	On	On			
Agc_mode	Automatic Gain	Integration Gain Adaptation																		
0b00	Off	Off																		
0b01	Off	On																		
0b10	On	Off																		
0b11	On	On																		
agc1.11 - agc1.10	exc_freq_high	High limit for excitation coil frequency range alarm. <table border="1"> <thead> <tr> <th>Exc_freq_high</th> <th>Excitation Coil Frequency [MHz]</th> </tr> </thead> <tbody> <tr> <td>0b00</td> <td>6.0</td> </tr> <tr> <td>0b01</td> <td>6.5</td> </tr> <tr> <td>0b10</td> <td>7.0</td> </tr> <tr> <td>0b11</td> <td>8.0</td> </tr> </tbody> </table> <p>An additional variance of about +/- 20% has to be taken into account to frequency variation of ZMID502X internal oscillator over temperature and voltage. The measurement time is ~ 100 us.</p>	Exc_freq_high	Excitation Coil Frequency [MHz]	0b00	6.0	0b01	6.5	0b10	7.0	0b11	8.0								
Exc_freq_high	Excitation Coil Frequency [MHz]																			
0b00	6.0																			
0b01	6.5																			
0b10	7.0																			
0b11	8.0																			
agc1.9 - agc1.8	exc_freq_low	Low limit for excitation coil frequency range alarm. <table border="1"> <thead> <tr> <th>Exc_freq_low</th> <th>Excitation Coil Frequency [MHz]</th> </tr> </thead> <tbody> <tr> <td>0b00</td> <td>1.0</td> </tr> <tr> <td>0b01</td> <td>1.5</td> </tr> <tr> <td>0b10</td> <td>2.0</td> </tr> <tr> <td>0b11</td> <td>2.5</td> </tr> </tbody> </table> <p>An additional variance of about +/- 20% has to be taken into account to frequency variation of ZMID4200 internal oscillator over temperature and voltage. The measurement time is ~ 100 us.</p>	Exc_freq_low	Excitation Coil Frequency [MHz]	0b00	1.0	0b01	1.5	0b10	2.0	0b11	2.5								
Exc_freq_low	Excitation Coil Frequency [MHz]																			
0b00	1.0																			
0b01	1.5																			
0b10	2.0																			
0b11	2.5																			
agc1.7	Reserved	Not used, read as 0 (SWR).																		
agc1.6 - agc1.4	cordmagul	Cordic magnitude upper level. (100%0x34B6.....13494d) <table border="1"> <thead> <tr> <th>Cordmagul</th> <th>Magnitude Upper Level [%]</th> </tr> </thead> <tbody> <tr> <td>0b111</td> <td>90</td> </tr> <tr> <td>0b110</td> <td>85</td> </tr> <tr> <td>0b101</td> <td>80</td> </tr> <tr> <td>0b100</td> <td>75</td> </tr> <tr> <td>0b011</td> <td>70</td> </tr> <tr> <td>0b010</td> <td>65</td> </tr> <tr> <td>0b001</td> <td>60</td> </tr> <tr> <td>0b000</td> <td>55</td> </tr> </tbody> </table>	Cordmagul	Magnitude Upper Level [%]	0b111	90	0b110	85	0b101	80	0b100	75	0b011	70	0b010	65	0b001	60	0b000	55
Cordmagul	Magnitude Upper Level [%]																			
0b111	90																			
0b110	85																			
0b101	80																			
0b100	75																			
0b011	70																			
0b010	65																			
0b001	60																			
0b000	55																			
agc1.3	Reserved	Not used, read as 0 (SWR).																		
agc1.2 - agc1.0	cordmagul	Cordic magnitude lower level. <table border="1"> <thead> <tr> <th>Cordmagul</th> <th>Magnitude Upper Level [%]</th> </tr> </thead> <tbody> <tr> <td>0b111</td> <td>55</td> </tr> <tr> <td>0b110</td> <td>50</td> </tr> <tr> <td>0b101</td> <td>45</td> </tr> <tr> <td>0b100</td> <td>40</td> </tr> <tr> <td>0b011</td> <td>35</td> </tr> <tr> <td>0b010</td> <td>30</td> </tr> <tr> <td>0b001</td> <td>25</td> </tr> <tr> <td>0b000</td> <td>20</td> </tr> </tbody> </table>	Cordmagul	Magnitude Upper Level [%]	0b111	55	0b110	50	0b101	45	0b100	40	0b011	35	0b010	30	0b001	25	0b000	20
Cordmagul	Magnitude Upper Level [%]																			
0b111	55																			
0b110	50																			
0b101	45																			
0b100	40																			
0b011	35																			
0b010	30																			
0b001	25																			
0b000	20																			

Notes: The reserved bits can be written and read to/from the block E2P. The copy process copies only defined bits to the SWR. The Cordic magnitude upper level should be higher than the lower level.

1.16 Mask

Address of register: 0x0E Default value: 0xBFFF.

The diagnostic mask, in the case that the output is set in the diagnostic state allows to prevent a diagnostic flag. The status of the latched diagnostic flags can be monitored by reading the diagnostic register.

Table 17. Mask Register Description

Bits	Symbol	Description	
mask.15	agc_low gain	AGC low gain status	
		Agc_low Gain	AGC Low Gain Alarm
		0b0	Enable
		0b1	Disable
mask.14	ee_ded	EEPROM double error detection	
		Ee_ded	Double Error Alarm
		0b0	Enable
		0b1	Disable
mask.13	r2_coil_fail	Receiver coil2 short/open check status	
		R2_coil_fail	Receiver Coil2 Short/Open Check Status
		0b0	Enable
		0b1	Disable
mask.12	r1_coil_fail	Receiver coil1 short/open check status	
		R1_coil_fail	Receiver Coil1 Short/Open Check Status
		0b0	Enable
		0b1	Disable
mask.11	Open	R1 or R2 receiver coil open	
		Open	R1 or R2 Receiver Coil Open
		0b0	Enable
		0b1	Disable
mask.10	rc_coil_short	R1 or R2 receiver coil short	
		Rc_coil_short	R1 or R2 Receiver Coil Short
		0b0	Enable
		0b1	Disable
mask.9	rc_gnd_short	R1 or R2 receiver coil short to gnd	
		Rc_gnd_short	R1 or R2 Receiver Coil Short to GND
		0b0	Enable
		0b1	Disable
mask.8	exc_break_p	Not used, read as 0 (SWR).	
		Exc_break_p	Excitation Coil Break P
		0b0	Enable
		0b1	Disable
mask.7	exc_break_n	Cordic magnitude lower level.	
		Exc_break_n	Excitation Coil Break N
		0b0	Enable
		0b1	Disable
mask.6	srb_parity	Shadow Register bank parity	
		Srb_parity	Shadow Register Bank Parity
		0b0	Enable
		0b1	Disable
mask.5	adc_dsp_ovfl	ADC digital signal processing overflow	
		Adc_dsp_ovfl	ADC Digital Signal Processing Overflow (Alarm)
		0b0	Enable
		0b1	Disable
mask.4	amp_dsp_ovfl	Amplitude digital signal processing overflow	
		Amp_dsp_ovfl	Amplitude Digital Signal Processing Overflow
		0b0	Enable
		0b1	Disable

Bits	Symbol	Description
mask.3	lc_osc_fail	LC oscillator range check
		Lc_osc_fail LC Oscillator Range Check
		0b0 Enable
		0b1 Disable
mask.2	lc_osc_stuck	LC oscillator stuck check
		C_osc_stuck LC Oscillator Stuck Check
		0b0 Enable
		0b1 Disable
mask.1	mag_low	Cordic magnitude is below threshold (lower limit, see section 1.16)
		C_osc_stuck Cordic Magnitude is Below Threshold (Lower Limit, 1.14)
		0b0 Enable
		0b1 Disable
mask.0	mag_high	Cordic magnitude is above threshold (upper limit, see section 1.16)
		mag_high Cordic Magnitude is Above Threshold (Upper Limit, 1.14)
		0b0 Enable
		0b1 Disable

1.17 Traceability0

E2P

Address of register: 0X0F.

Default value: none, read only.

Renesas identification and version number.

Table 18. Traceability0 Register Description

Bits	Symbol	Description
trace0.15 - trace0.0	IDT_id	Renesas Identification and version number.

1.18 Traceability1

E2P

Address of register: 0x10.

Default value: none, read only.

Renesas identification and version number.

Table 19. Traceability1 Register Description

Bits	Symbol	Description
Trace1.15 - Trace1.0	IDT_id	Renesas Identification and version number.

1.19 Misc

Address of register: 0x11.

Default value: 0x00C2.

Table 20. Misc Register Description

Bits	Symbol	Description						
misc.15 - misc.9	IDT	Renesas internal						
misc.8	agc_offset_sat_mode	AGC offset saturation mode. If this mode is activated an offset saturation detection forces the gain regulation to decrement the gain step to decrease the ADC input signal level.						
		<table border="1"> <thead> <tr> <th>agc_offset_sat_mode</th> <th>AGC Offset Saturation Mode</th> </tr> </thead> <tbody> <tr> <td>0b0</td> <td>Extension off</td> </tr> <tr> <td>0b1</td> <td>Extension on</td> </tr> </tbody> </table>	agc_offset_sat_mode	AGC Offset Saturation Mode	0b0	Extension off	0b1	Extension on
		agc_offset_sat_mode	AGC Offset Saturation Mode					
0b0	Extension off							
0b1	Extension on							
<table border="1"> <thead> <tr> <th>exc_type</th> <th>Coil Alarm Type Selection</th> </tr> </thead> <tbody> <tr> <td>0b0</td> <td>Event alarm type</td> </tr> <tr> <td>0b1</td> <td>Latched alarm type</td> </tr> </tbody> </table>	exc_type	Coil Alarm Type Selection	0b0	Event alarm type	0b1	Latched alarm type		
exc_type	Coil Alarm Type Selection							
0b0	Event alarm type							
0b1	Latched alarm type							
misc.7	exc_type	Excitation coil alarm type selection (exc_break_p, exc_break_n)						
misc.6- misc.0	IDT	Renesas internal						

1.20 Afe_Agc

Address of register: 0x13.

Default value: none, read only.

The integration time regulation adapts the number of integration time cycles that a constant integration time independent of the LC-frequency is achieved. The adjusted cycle number can be monitored by reading the parameter `agc_intgr`. The automatic gain regulation process (AGC1) modify the gain by a decision circuit which compares the actual cordic magnitude with the programmed cordic magnitude limits. The adjusted gain value can be monitored by reading the register. The phase information is the polarity of the incoming R1/R2 signal respectively the polarity of the decimated samples R1/2.

Table 21. Afe_Agc Register Description

Bits	Symbol	Description	
afe_agc.15 - afe_agc.13	Reserved	Not used, read as 0 (SWR).	
afe_agc.12 - afe_agc.8	agc_intgr	AGC adjusted number of integration cycles effective integration time = (7 + agc_intgr) x I _c clock period.	
afe_agc.7 - afe_agc.4	agc_gain stage	AGC adjusted gain stage value range 0x0...0xC.	
afe_agc.3	r1_polarity	Polarity of receiver coil R1	
		R1_polarity	Polarity of Receiver Coil R1
		0b0	Negative
		0b1	Positive
afe_agc.2	r2_polarity	Polarity of receiver coil R2	
		R2_polarity	Polarity of Receiver Coil R2
		0b0	Negative
		0b1	Positive
afe_agc.1	y_cos_pol	Phase polarity of Ycosine amplitude parameter. The sensor position is calculated based on the receiver amplitude (see sections 1.21 and 1.22) and related phase polarity.	
afe_agc.0	x_sin_pol	Phase polarity of Xsine amplitude parameter. The sensor position is calculated based on the receiver amplitude (see sections 1.21 and 1.22) and related phase polarity.	

1.21 Xsine

Address of register: 0x14.

Default value: none, read only.

The amplitude of the receiver coils after decimation and amplitude offset evaluation (sampler output) can be monitored by reading the register Xsine.

Table 22. Xsine Register Description

Bits	Symbol	Description
xsine.15 -xsine.13	Reserved	Not used, read as 0 (SWR).
xsine.12 -xsine.0	x_sin_amp	Amplitude of receiver coil. Absolute amplitude after decimation and amplitude offset evaluation.

1.22 Ycosine

Address of register: 0x15.

Default value: none, read only.

The amplitude of the receiver coil after decimation and amplitude offset evaluation (sampler output) can be monitored by reading the register Ycosine.

Table 23. Ycosine Register Description

Bits	Symbol	Description
xsine.15 -xsine.13	Reserved	Not used, read as 0 (SWR).
xsine.12 –xsine.0	y_cos_amp	Amplitude of receiver coil absolute amplitude after decimation and amplitude offset evaluation.

1.23 Angle

Address of register: 0x16.

Default value: None; read only.

The sensor position is calculated based on the x_sin_amp (see section 1.21) and y_cos_amp (see section 1.22) parameter. The result of 90 degree angle is calculated by $\arctan\left(\frac{x_sin_amp}{y_cos_amp}\right)$.

The trigonometric function is implemented by an iterative CORDIC (Coordinate Rotation Digital Computer) architecture. The chosen number of iteration steps is 16. CORDIC works by rotating the coordinate system through constant angles until the angle is reduced to zero and the result vector is aligned with the X axis. The result of the vectoring operation is a rotation angle (0deg <= angle <= 90deg) and the scaled magnitude of the original vector. The calculated rotation angle is mapped to a 15-bit vector and can be monitored by the angle register read access.

Table 24. Angle Register Description

Bits	Symbol	Description								
angle.15	Reserved	Not used, read as 0 (SWR).								
angle.14 – angle.0	cordic angle	Rotational CORDIC angle from 0 degree to 90 degree. <table border="1" style="width: 100%; margin-top: 5px;"> <thead> <tr> <th>Cordic Angle</th> <th>Angle [Degree]</th> </tr> </thead> <tbody> <tr> <td>0x0000</td> <td>0</td> </tr> <tr> <td>.....</td> <td>.....</td> </tr> <tr> <td>0x7FFF</td> <td>90</td> </tr> </tbody> </table>	Cordic Angle	Angle [Degree]	0x0000	0	0x7FFF	90
Cordic Angle	Angle [Degree]									
0x0000	0									
.....									
0x7FFF	90									

1.24 Cordic Magnitude

Address of register: 0x17

Default value: None: read only

The CORDIC algorithm in vectoring mode works by seeking to minimize the Ycosine component of the residual vector at each rotation. The result of the vectoring operation is a rotation angle (see section 1.23) and the scaled magnitude of the original vector $\sqrt{Xsine^2 + Ycosine^2}$.

The aggregate constant of all 16 iteration steps resp. the scale factor is $\frac{1}{0.607}$

It follows for the cordic magnitude:

$$\text{Cordic magnitude} = \frac{\sqrt{Xsine^2 + Ycosine^2}}{0.607}$$

Assumption: Saturation of both receiver channels:

$$Xsine = Ycosine = 0x1FFF$$

$$\text{cordic magnitude(sat)} = 0x4A8B$$

Assumption: Signals of both receive channels at ideal amplification (below saturation).

$$Xsine = 0x1FFF \quad Ycosine = 0x0000$$

$$\text{cordic magnitude(opt)} = 0x34B6$$

Conclusion: The cordic magnitude is a monitor for gain respectively integration time setting. It is important that the magnitude does not exceed the optimum level. Otherwise this will lead to a failure in the position calculation (nonlinearity).

Table 25. Mag Register Description

Bits	Symbol	Description								
angle.15	Reserved	Not used, read as 0 (SWR).								
angle.14 – angle.0	cordic angle	Rotational CORDIC magnitude from minimum magnitude saturation. <table border="1" style="width: 100%; border-collapse: collapse;"> <thead> <tr> <th style="width: 50%;">Cordic Mag</th> <th style="width: 50%;">Magnitude</th> </tr> </thead> <tbody> <tr> <td>0x4A8B</td> <td>Sat</td> </tr> <tr> <td>0x34B6</td> <td>Opt</td> </tr> <tr> <td>0x0000</td> <td>Min</td> </tr> </tbody> </table>	Cordic Mag	Magnitude	0x4A8B	Sat	0x34B6	Opt	0x0000	Min
Cordic Mag	Magnitude									
0x4A8B	Sat									
0x34B6	Opt									
0x0000	Min									

1.25 SPA

Address of register: 0x18.

Default value: None: read only.

The CORDIC processor output angle is expanded by the phase polarity information (y_cos_pol & x_sin_pol) to a range from 0 deg to 360 deg. The ZMID4200 internal notation is a 17-bit vector (4 x angle 15-bit). Due to the 16-bit wide data structure of the OWI interface, the spatial angle vector is truncated to 16 bits (17 down to 1) for the read-access.

Table 26. Spa Register Description

Bits	Symbol	Description						
spa.15 - spat.0	spatial angle	Spatial angle Expanded cordic angle to 360 degree range. The value is before calibration and linear error correction. The ZMID4200 internal notation is a 17-bit wide vector. From 0 deg to 360 deg. <table border="1" style="width: 100%; border-collapse: collapse;"> <thead> <tr> <th style="width: 50%;">Spatial Angle</th> <th style="width: 50%;">Spatial Angle [Degree]</th> </tr> </thead> <tbody> <tr> <td>0x0000</td> <td>0 min</td> </tr> <tr> <td>0xFFFF</td> <td>360 max</td> </tr> </tbody> </table>	Spatial Angle	Spatial Angle [Degree]	0x0000	0 min	0xFFFF	360 max
Spatial Angle	Spatial Angle [Degree]							
0x0000	0 min							
0xFFFF	360 max							

Note: Due to the truncation of the spatial angle number range to 16-bit (OWI access), the number range of the cordic angle has to be also truncated by one bit (14 down to 1) for direct comparison of this two parameters.

1.26 Pos0

Address of register: 0x19.

Default value: None: read only.

The spatial angle is modified by the calibration parameter slope & offset (see sections 1.2 and 1.3) and the linearity error correction. The pos0 value is the calculated value with linearity error correction before calibration (see section 1.11, corr_mod = 0).

Table 27. Pos0 Register Description

Bits	Symbol	Description						
pos0.15 - pos0.0	pos_so_corr0	Position before calibration & linearity error correction (linear error correction pre-calibration corr_mode = 0), see section 1.11.						
		<table border="1"> <thead> <tr> <th>Spatial Angle</th> <th>Spatial Angle [Degree]</th> </tr> </thead> <tbody> <tr> <td>0x0000</td> <td>0</td> </tr> <tr> <td>0xFFFF</td> <td>360</td> </tr> </tbody> </table>	Spatial Angle	Spatial Angle [Degree]	0x0000	0	0xFFFF	360
Spatial Angle	Spatial Angle [Degree]							
0x0000	0							
0xFFFF	360							

1.27 Pos1

Address of register: 0x1A Default value: None: read only.

The spatial angle is modified by the calibration parameter slope & offset (see sections 1.2 and 1.3) and the linearity error correction. The pos1 value is the calculated value with linearity error correction after calibration (see section 1.11, corr_mod = 1).

Table 28. Pos1 Register Description

Bits	Symbol	Description						
pos0.15 - pos0.0	pos_so_corr1	Position after calibration & linearity error correction (linear error correction post-calibration, corr_mod= 1), see section 1.11.						
		<table border="1"> <thead> <tr> <th>Spatial Angle</th> <th>Spatial Angle [Degree]</th> </tr> </thead> <tbody> <tr> <td>0x0000</td> <td>0</td> </tr> <tr> <td>0xFFFF</td> <td>360</td> </tr> </tbody> </table>	Spatial Angle	Spatial Angle [Degree]	0x0000	0	0xFFFF	360
Spatial Angle	Spatial Angle [Degree]							
0x0000	0							
0xFFFF	360							

Note: For the different output protocols the calculated position is truncated from MSB down to 1/5/7. For the SENT respectively PWM/Analog the remainder is rounded.

Note: If corr_mod = 0b0 (1.10, calout.3) pos_so_corr1 is equal pos_so_corr0 (1.25).

2. Glossary

Acronym	Definition
ADC	Analog Digital Converter
ATE	Automatic Test Equipment
ATPG	Automatic Test Pattern Generation
PPU	Position Processing Unit
E2P	Electrically Erasable Programmable Read Only Memory
ECU	Electronic Control Unit
ECC	Error Correction Code
FEC	Forward Error Correction
GND	Ground
IC	Integrated Circuit
LSB	Least Significant Bit
MSB	Most Significant Bit
OWI	One Wire Interface
OSR	Over Sampling Rate
PPR	Pulse Pause Ratio
SWR	Shadow Word Register bank
TDM	Time Division Multiplexer

3. Revision History

Revision Date	Description of Change
October 16, 2024	Corrected typos: <ul style="list-style-type: none"> ▪ output 7, 3, 2 on page 19 ▪ on page 18 ▪ on page 30
July 21, 2021	Initial release

Notice

1. Descriptions of circuits, software and other related information in this document are provided only to illustrate the operation of semiconductor products and application examples. You are fully responsible for the incorporation or any other use of the circuits, software, and information in the design of your product or system. Renesas Electronics disclaims any and all liability for any losses and damages incurred by you or third parties arising from the use of these circuits, software, or information.
2. Renesas Electronics hereby expressly disclaims any warranties against and liability for infringement or any other claims involving patents, copyrights, or other intellectual property rights of third parties, by or arising from the use of Renesas Electronics products or technical information described in this document, including but not limited to, the product data, drawings, charts, programs, algorithms, and application examples.
3. No license, express, implied or otherwise, is granted hereby under any patents, copyrights or other intellectual property rights of Renesas Electronics or others.
4. You shall be responsible for determining what licenses are required from any third parties, and obtaining such licenses for the lawful import, export, manufacture, sales, utilization, distribution or other disposal of any products incorporating Renesas Electronics products, if required.
5. You shall not alter, modify, copy, or reverse engineer any Renesas Electronics product, whether in whole or in part. Renesas Electronics disclaims any and all liability for any losses or damages incurred by you or third parties arising from such alteration, modification, copying or reverse engineering.
6. Renesas Electronics products are classified according to the following two quality grades: "Standard" and "High Quality". The intended applications for each Renesas Electronics product depends on the product's quality grade, as indicated below.
 - "Standard": Computers; office equipment; communications equipment; test and measurement equipment; audio and visual equipment; home electronic appliances; machine tools; personal electronic equipment; industrial robots; etc.
 - "High Quality": Transportation equipment (automobiles, trains, ships, etc.); traffic control (traffic lights); large-scale communication equipment; key financial terminal systems; safety control equipment; etc.
- Unless expressly designated as a high reliability product or a product for harsh environments in a Renesas Electronics data sheet or other Renesas Electronics document, Renesas Electronics products are not intended or authorized for use in products or systems that may pose a direct threat to human life or bodily injury (artificial life support devices or systems; surgical implantations; etc.), or may cause serious property damage (space system; undersea repeaters; nuclear power control systems; aircraft control systems; key plant systems; military equipment; etc.). Renesas Electronics disclaims any and all liability for any damages or losses incurred by you or any third parties arising from the use of any Renesas Electronics product that is inconsistent with any Renesas Electronics data sheet, user's manual or other Renesas Electronics document.
7. No semiconductor product is absolutely secure. Notwithstanding any security measures or features that may be implemented in Renesas Electronics hardware or software products, Renesas Electronics shall have absolutely no liability arising out of any vulnerability or security breach, including but not limited to any unauthorized access to or use of a Renesas Electronics product or a system that uses a Renesas Electronics product. RENESAS ELECTRONICS DOES NOT WARRANT OR GUARANTEE THAT RENESAS ELECTRONICS PRODUCTS, OR ANY SYSTEMS CREATED USING RENESAS ELECTRONICS PRODUCTS WILL BE INVULNERABLE OR FREE FROM CORRUPTION, ATTACK, VIRUSES, INTERFERENCE, HACKING, DATA LOSS OR THEFT, OR OTHER SECURITY INTRUSION ("Vulnerability Issues"). RENESAS ELECTRONICS DISCLAIMS ANY AND ALL RESPONSIBILITY OR LIABILITY ARISING FROM OR RELATED TO ANY VULNERABILITY ISSUES. FURTHERMORE, TO THE EXTENT PERMITTED BY APPLICABLE LAW, RENESAS ELECTRONICS DISCLAIMS ANY AND ALL WARRANTIES, EXPRESS OR IMPLIED, WITH RESPECT TO THIS DOCUMENT AND ANY RELATED OR ACCOMPANYING SOFTWARE OR HARDWARE, INCLUDING BUT NOT LIMITED TO THE IMPLIED WARRANTIES OF MERCHANTABILITY, OR FITNESS FOR A PARTICULAR PURPOSE.
8. When using Renesas Electronics products, refer to the latest product information (data sheets, user's manuals, application notes, "General Notes for Handling and Using Semiconductor Devices" in the reliability handbook, etc.), and ensure that usage conditions are within the ranges specified by Renesas Electronics with respect to maximum ratings, operating power supply voltage range, heat dissipation characteristics, installation, etc. Renesas Electronics disclaims any and all liability for any malfunctions, failure or accident arising out of the use of Renesas Electronics products outside of such specified ranges.
9. Although Renesas Electronics endeavors to improve the quality and reliability of Renesas Electronics products, semiconductor products have specific characteristics, such as the occurrence of failure at a certain rate and malfunctions under certain use conditions. Unless designated as a high reliability product or a product for harsh environments in a Renesas Electronics data sheet or other Renesas Electronics document, Renesas Electronics products are not subject to radiation resistance design. You are responsible for implementing safety measures to guard against the possibility of bodily injury, injury or damage caused by fire, and/or danger to the public in the event of a failure or malfunction of Renesas Electronics products, such as safety design for hardware and software, including but not limited to redundancy, fire control and malfunction prevention, appropriate treatment for aging degradation or any other appropriate measures. Because the evaluation of microcomputer software alone is very difficult and impractical, you are responsible for evaluating the safety of the final products or systems manufactured by you.
10. Please contact a Renesas Electronics sales office for details as to environmental matters such as the environmental compatibility of each Renesas Electronics product. You are responsible for carefully and sufficiently investigating applicable laws and regulations that regulate the inclusion or use of controlled substances, including without limitation, the EU RoHS Directive, and using Renesas Electronics products in compliance with all these applicable laws and regulations. Renesas Electronics disclaims any and all liability for damages or losses occurring as a result of your noncompliance with applicable laws and regulations.
11. Renesas Electronics products and technologies shall not be used for or incorporated into any products or systems whose manufacture, use, or sale is prohibited under any applicable domestic or foreign laws or regulations. You shall comply with any applicable export control laws and regulations promulgated and administered by the governments of any countries asserting jurisdiction over the parties or transactions.
12. It is the responsibility of the buyer or distributor of Renesas Electronics products, or any other party who distributes, disposes of, or otherwise sells or transfers the product to a third party, to notify such third party in advance of the contents and conditions set forth in this document.
13. This document shall not be reprinted, reproduced or duplicated in any form, in whole or in part, without prior written consent of Renesas Electronics.
14. Please contact a Renesas Electronics sales office if you have any questions regarding the information contained in this document or Renesas Electronics products.

(Note1) "Renesas Electronics" as used in this document means Renesas Electronics Corporation and also includes its directly or indirectly controlled subsidiaries.

(Note2) "Renesas Electronics product(s)" means any product developed or manufactured by or for Renesas Electronics.

(Disclaimer Rev.5.0-1)

Corporate Headquarters

TOYOSU FORESIA, 3-2-24 Toyosu,
Koto-ku, Tokyo 135-0061, Japan
www.renesas.com

Trademarks

Renesas and the Renesas logo are trademarks of Renesas Electronics Corporation. All trademarks and registered trademarks are the property of their respective owners.

Contact Information

For further information on a product, technology, the most up-to-date version of a document, or your nearest sales office, please visit:
www.renesas.com/contact/