

User Manual

DA9318 Direct Charging Reference Board

UM-PM-022

Abstract

This document describes the hardware and software used to evaluate the DA9318 direct charging reference board.

DA9318 Direct Charging Reference Board
Contents

Abstract	1
Contents	2
1 Terms and Definitions	3
2 References	3
3 Introduction	4
4 Functional Description	6
4.1 Main Charger	6
4.2 Power Monitor	8
4.3 Direct Charging	8
4.4 Over-Voltage Protection	8
4.5 Direct Charging Sequence	9
5 DA9318 Direct Charging Reference Board Hardware	10
5.1 Default Link Positions and Connector Definitions	11
5.2 USB Interface	14
5.2.1 USB Power and GUI Reset	14
5.3 Power Supplies	14
6 DA9318 Direct Charging Reference Board Software	15
6.1 GUI Installation	15
6.1.1 GUI Installation Step By Step Guide	16
6.2 Initial USB Connection	20
7 GUI Software	21
7.1 Controls	21
7.2 Control Widgets	22
7.2.1 Enable/Disable Polling	22
7.2.2 Charging Status Indicators	22
7.2.3 Charge Status Indicators	23
7.2.4 Raw I/O	25
7.2.5 Interface Control Information	25
7.2.6 I ² C Bus Scan	25
7.2.7 Settings	26
7.3 Quick Start Guide	27
7.3.1 Manual Charge Operation	27
7.3.1.1 Operational Steps	28
7.3.2 Automatic Charge Operation	30
7.3.2.1 Customer Configuration	31
7.3.2.2 Operational Steps	32
7.3.2.3 Charge Cycles Examples	33
Revision History	37

DA9318 Direct Charging Reference Board

1 Terms and Definitions

GND	Ground
GUI	Graphical User Interface
IC	Integrated Circuit
JTAG	Joint Test Action Group
LED	Light Emitting Diode
LS	Level Shifter
OTG	On-The-Go
PC	Personal Computer
PD	Power Delivery
RCP	Reverse Current Protection
SAM3U	USB I ² C Interface
SCL	Serial CLock
SDA	Serial DAta
TA	Travel Adaptor
USB	Universal Serial Bus

2 References

- [1] DA9318 Datasheet, Dialog Semiconductor
- [2] 329-03-D_ SCH.pdf, Dialog Semiconductor
- [3] DA9318_Direct_Charging_Rev2.2.pdf, Dialog Semiconductor (under NDA)

DA9318 Direct Charging Reference Board

3 Introduction

The purpose of the reference board is to demonstrate DA9318 in a direct charging application.

The document covers a normal charging cycle, using an off-the-shelf charger IC and a charging cycle with the direct charging enabled. Direct charging means connecting the travel adaptor (TA) directly to the battery in the constant current charging phase. A block diagram of the DA9318 direct charging reference board is shown in [Figure 1](#).

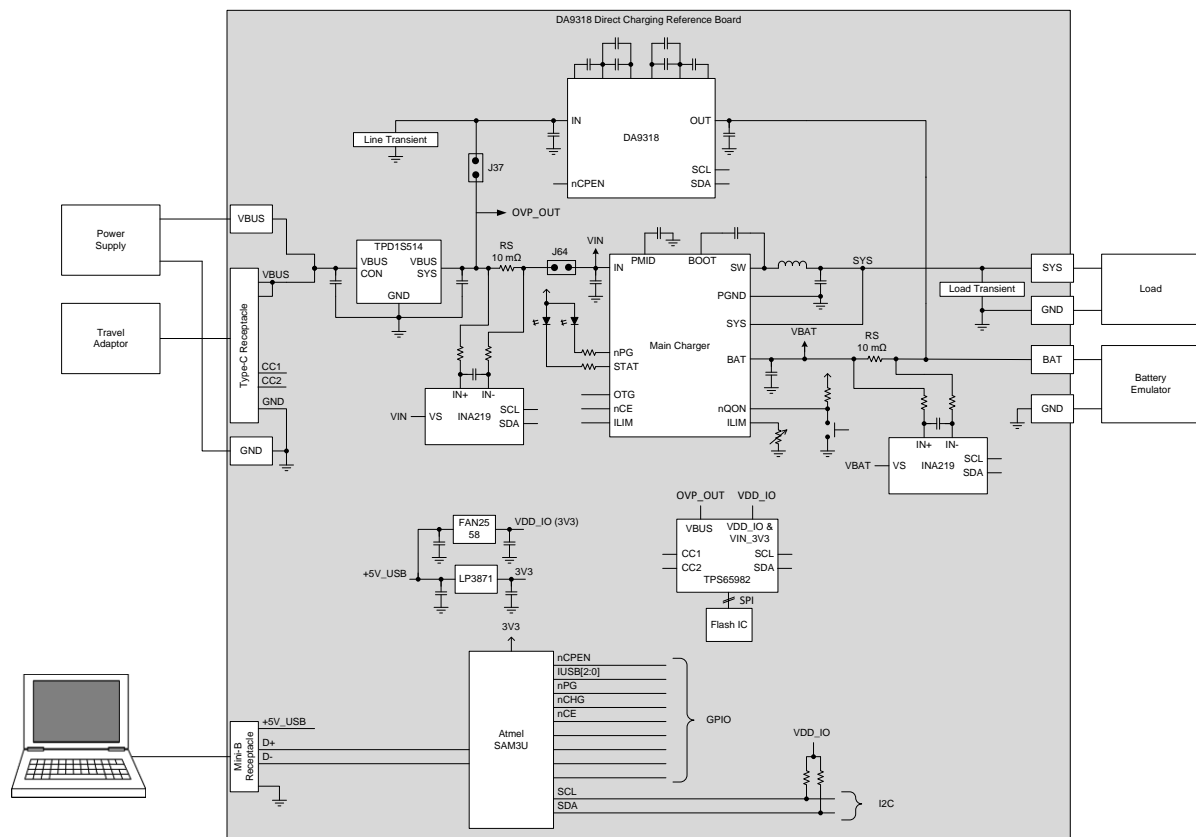

Figure 1: DA9318 Direct Charging Block Diagram

The DA9318 direct charging reference board, see [Figure 2](#), facilitates the measurement, evaluation, and configuration of a battery charging cycle when connected to a TA that includes the iW1781 primary side controller, iW676 secondary side controller and iW656 USB PD interface controller chip set.

Dialog’s software package [SmartCanvas™](#) uses a simple graphical user interface which enables DA9318 to be controlled via the USB port of a PC. The mini USB connection is visible on the left side of the board. When the cable is connected to the USB port of the PC the green LED (D3) is on.

The board contains jumper links, see [Figure 6](#), to provide access to alternative configurations and measurement test points. Most standard operating modes are evaluated with minimal link changes.

DA9318 Direct Charging Reference Board

4 Functional Description

During direct charging the main charger of the battery operated device is bypassed and the Dialog TA is directly connected to the battery.

The difference between normal charging and direct charging is illustrated in [Figure 3](#).

In order for the direct charging to work, the TA has to have a configurable output voltage and current limit. Currently the Dialog's 33 W TA can support output voltages of between 3.3 V and 11 V in 25 mV steps, and current limits up to 3 A in 50 mA steps.

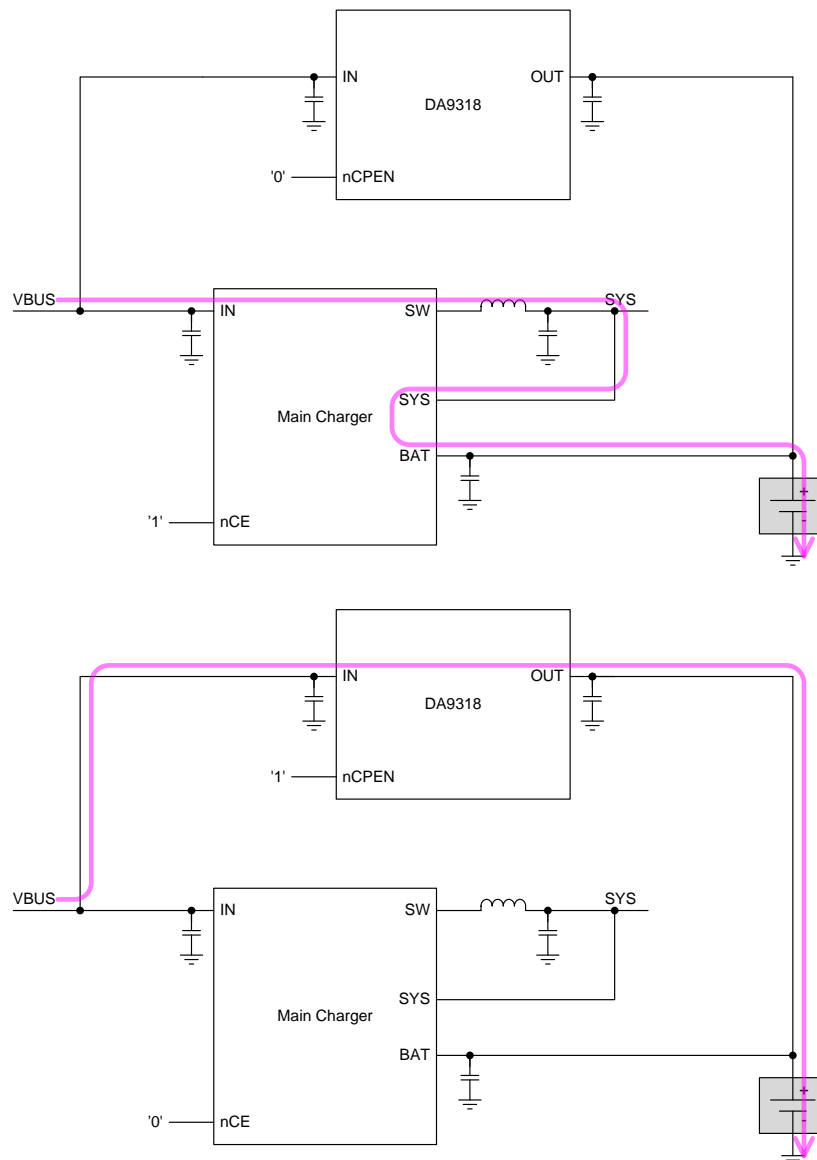

Figure 3: Normal Charging (Top) and Direct Charging (Bottom)

4.1 Main Charger

The main charger is capable of handling a complete charging cycle without host interaction.

The input current limit is set via GPIOs and the charging current and dynamic power management thresholds are set with external pull-down resistors.

DA9318 Direct Charging Reference Board

The charging statuses are communicated via LEDs. The main charger can be enabled with the nCE signal driven from the microcontroller. During direct charging the main charger is disabled.

DA9318 Direct Charging Reference Board

4.2 Power Monitor

Two power monitor ICs (INA226), fitted on the DA9318 direct charging reference board, allow for measurement of the main charger input voltage and input current, and for monitoring the battery current and voltage.

That information is read out via the I²C interface and used in the control GUI software running on the PC.

When direct charging is enabled, the DA9318 internal ADC is monitoring the input/output current and input/output voltage.

Power monitoring is a safety feature associated with direct charging. The input power of the mobile device has to be compared to the output power of the TA. A mismatch indicates a fault condition and the charging has to be terminated.

4.3 Direct Charging

Reverse current protection (RCP) is enabled whenever DA9318 is not in the ACTIVE mode.

DA9318 is capable of starting up when V_{IN} is within the accepted range defined by V_{IN2OUT_MIN} and V_{IN2OUT_MAX} . If V_{IN} is not within the accepted range during start-up, the start-up is aborted.

When the above conditions are satisfied the DA9318 can be enabled by writing CP_EN to allow for direct charging. The TA voltage is set accordingly to allow the pre-defined charge current into the battery.

During direct charging the main charger is disabled.

4.4 Over-Voltage Protection

Over-voltage protection (OVP) is needed for general protection of devices connected to VBUS.

TI TPD1S514, Fairchild FPF2280, and Kinetic KTS1682 can be used as they all are pinout compatible parts with very similar feature sets.

DA9318 Direct Charging Reference Board

4.5 Direct Charging Sequence

A sequence diagram for direct charging is depicted in Figure 4.

NOTE
 The DA9318 direct charging reference board communication to the TA is achieved using USB PD communication protocol. The sequence diagram in Figure 4 is provided for information only. Please contact ic-support@diasemi.com for more information.

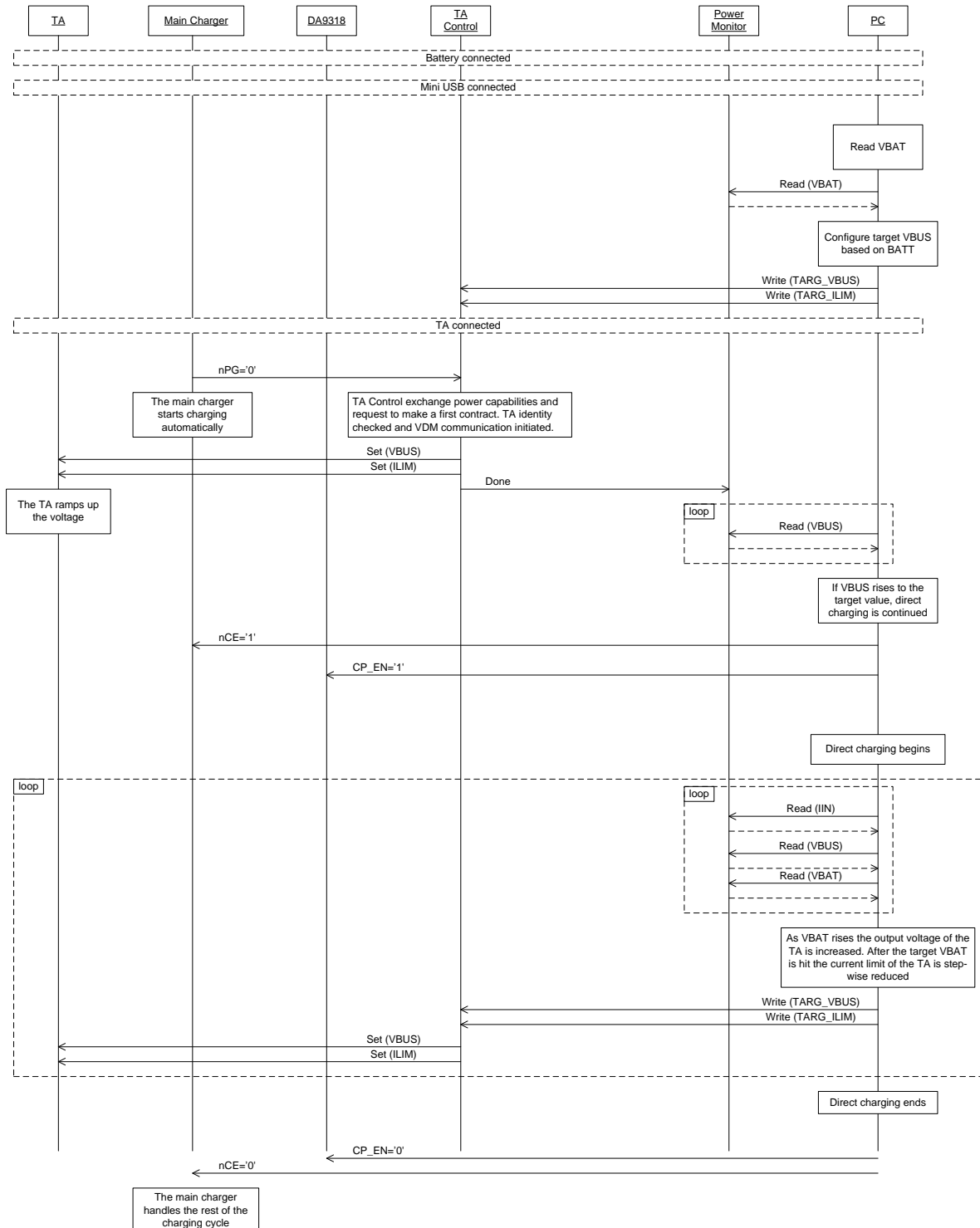

Figure 4: Sequence Diagram for Direct Charging

DA9318 Direct Charging Reference Board

5 DA9318 Direct Charging Reference Board Hardware

The DA9318 direct charging reference board functionality can be broken down into sections, see Figure 5:

- USB Type-C™ cable input, OVP switch, input connector.
- Main charger / ADCs.
- DA9318 direct charging.
- USB PD.
- USB interface (I²C communication) and USB reset.
- Voltage monitoring connectors and IOs.
- Battery and system connectors.

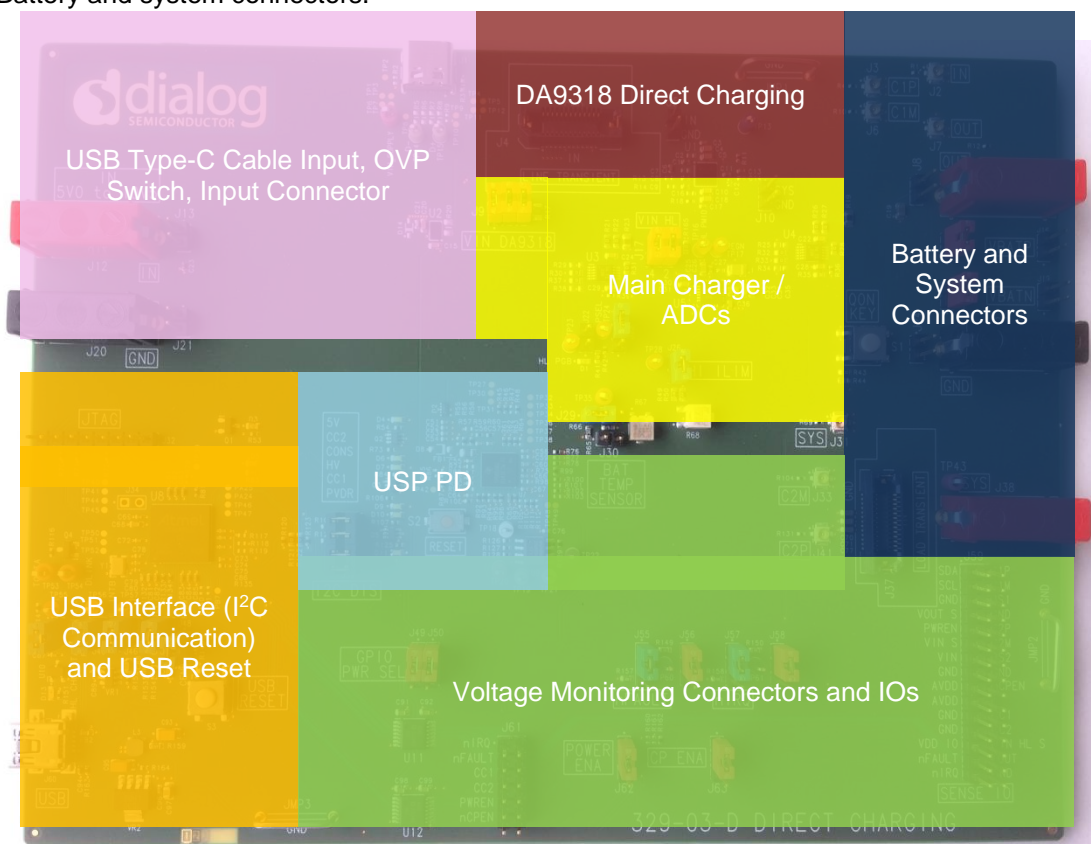

Figure 5: Functional Sections

DA9318 Direct Charging Reference Board

5.1 Default Link Positions and Connector Definitions

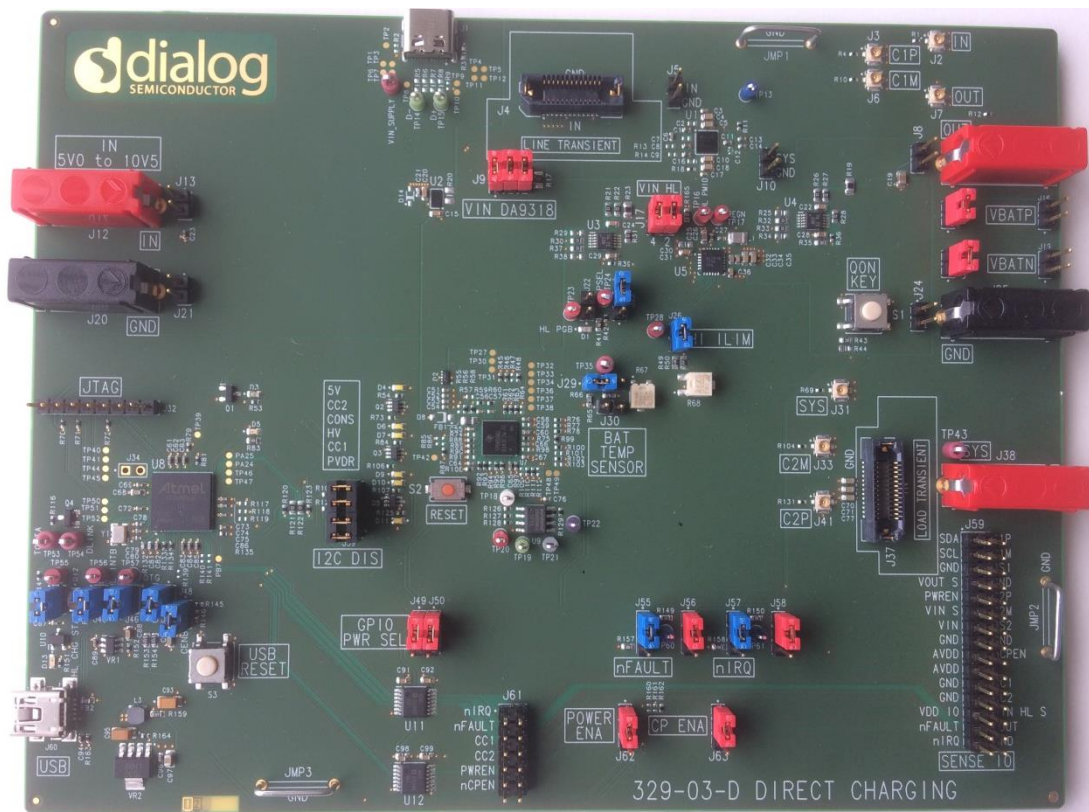

Figure 6: Default Link Positions

Table 1: Default Link Positions and Connector Definitions

Reference Designator	Position	Function
J1	NA	USB-C inlet
J2	NA	SMA connector for measuring IN
J3	NA	SMA connector for measuring C1P
J4	NA	Line transient connector
J5	1	IN sense point
	2	GND sense point
J6	NA	SMA connector for measuring C1N (labeled as C1M)
J7	NA	SMA connector for measuring OUT
J8	NA	OUT connector
J9	1-2, 3-4, 5-6 (Close)	IN connector shunt to IN of DA9318
J10	1	SYS sense point
	2	GND sense point
J11	NA	OUT connector

DA9318 Direct Charging Reference Board

Reference Designator	Position	Function
J12	NA	IN connector
J13	NA	IN connector
J15	Close (Default)	Short VOUT_DA9318 to VBATP for a local pack sensing
	Open	VOUT_DA9318 and VBATP disconnected to allow cell sensing
J16	NA	VBATP connector for cell sensing
J17	1-2 (Close)	DA9318 input disconnect
	3-4 (Close)	
J18	Close (Default)	Short GND to VBATN for a local pack sensing
	Open	GND and VBATN disconnected to allow cell sensing
J19	NA	VBATN connector for cell sensing
J20	NA	GND connector (IN side of board)
J21	NA	GND connector (IN side of board)
J22	1-2 (Open)	Main charger PGB GPIO connection to SAM3U
J23	1-2	Main charger PSEL settings
	2-3 (Close)	
J24	NA	GND connector (OUT side of board)
J25	NA	GND connector (OUT side of board)
J26	1-2 (Close)	Main charger Current Limit settings
J29	1-2 (Close)	Main charger thermistor connection
	2-3	
J30	1-2 (Open)	Main charger thermistor sensor short to ground
J31	NA	SMA connector for measuring SYS
J32	NA	JTAG: reserved
J33	NA	SMA connector for measuring C2N (labeled as C2M)
J34	1-2 (Open)	Important: This erases the USB IC firmware. DO NOT SHORT
J37	NA	Load transient connector
J38	NA	SYS connector
J39	1-2 (Close)	SCL from SAM3U connected to DA9318
	3-4 (Close)	SDA from SAM3U connected to DA9318
	5-6 (Close)	SCL from SAM3U connected to USB PD IC
	7-8 (Close)	SDA from SAM3U connected to USB PD IC
J41	NA	SMA connector for measuring C2P
J44	1-2 (Close)	Main charger Status read connection to Atmel
J45	1-2 (Close)	INTB GPIO connection to SAM3U
J46	1-2 (Close)	OTG to Ground
J47	1-2 (Close)	Main charger enable through GPIO
J48	1-2 (Close)	Main charger enable
J49	1-2 (Close)	Both sides of level shifter set to VDD_IO
	2-3	Level shift from AVDD to VDD_IO

DA9318 Direct Charging Reference Board

Reference Designator	Position	Function
J50	1-2 (Close)	Both sides of level shifter set to VDD_IO
	2-3	Level shift from AVDD to VDD_IO
J55	1-2 (Close)	nFAULT pulled up to rail selected by J56
	2-3	nFAULT pulled to ground
J56	1-2 (Close)	nFAULT PU selection: VDD_IO
	2-3	nFAULT PU selection: AVDD
J57	1-2 (Close)	nIRQ pulled up to rail selected by J58
	2-3	nIRQ pulled to ground
J58	1-2 (Close)	nIRQ PU selection: VDD_IO
	2-3	nIRQ PU selection: AVDD
J59	NA	Measurement header
J60	NA	USB inlet
J61	1-2 (Close)	nIRQ connected to level shifter and SAM3U
	3-4 (Close)	nFAULT connected to level shifter and SAM3U
	5-6 (Close)	CC1 connected to level shifter and SAM3U
	7-8 (Close)	CC2 connected to level shifter and SAM3U
	9-10 (Close)	PWREN connected to level shifter and SAM3U
	11-12 (Close)	nCPEN connected to level shifter and SAM3U
J62	1-2 (Close)	PWREN sorted to AVDD (options available for connection to +5V or SYS)
	2-3	PWREN shorted to GND to enter NO-POWER mode
J63	1-2 (Close)	nCPEN shorted to AVDD
	2-3	nCPEN shorted to GND
S1	NA	Main charger ON switch
S2	NA	USB PD HRESET switch
S3	NA	Push button to reset the USB IC

DA9318 Direct Charging Reference Board

5.2 USB Interface

The DA9318 direct charging board uses an ATMEL® SAM3U® microcontroller as the USB transceiver, programmed to deliver the following functionalities:

- I²C control interfaces.
- Discrete digital IO control (General Purpose Input Output (GPIO) and dedicated functions).

5.2.1 USB Power and GUI Reset

The USB is powered by an on-board regulator (VR2), see Figure 7. Pressing the USB RESET switch S3 shuts down the on-board regulator VR2, powering down the supply for the SAM3U (USB I²C interface). This resets the GUI communication with the reference board.

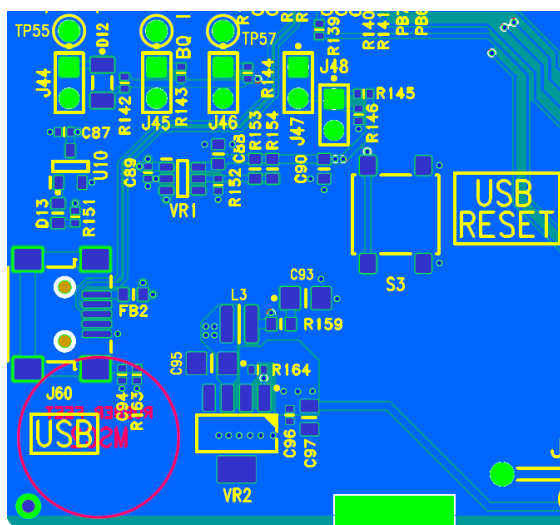

Figure 7: USB Interface Connector and Reset Switch

Table 2: Power Configuration Switch

Switch Name	Reference Designator	Type	Function
USB RESET	S3	Push button	Shuts down the on-board regulator that generates the interface supply

5.3 Power Supplies

The DA9318 direct charging board is powered up when a power source is connected to IN (J12). IN operating voltage range is +5.5 V to +10.5 V.

- The VDD_IO voltage is generated by an on-board regulator (VR1) supplied from the +5 V USB. By default, the on-board generated VDD_IO is +3.3 V.

NOTE
For correct operation, connect the reference board to a USB port capable of supplying 500 mA.

DA9318 Direct Charging Reference Board

6 DA9318 Direct Charging Reference Board Software

The board is controlled using a graphical user interface (GUI), which requires a PC operating Windows® 2000/XP/Vista/Windows 7 with a USB1.1 or USB2 interface. The GUI allows the user to:

- Perform raw write and read operations to all control registers on Dialog and non-Dialog ICs.
- Monitor the charging status.
- Plot the DA9318 efficiency over time with saving and zoom feature.
- Plot the main charger efficiency over time with saving and zoom feature.
- Plot the DA9318 temperature over time with saving and zoom feature.
- Poll the DA9318 registers.
- Read ADC data from DA9318 (V_{IN} , V_{BAT} , I_{IN} , I_{OUT} and T_{JUNC}) when the DA9318 is enabled.
- Read ADC data from external ADC ICs (V_{IN} , V_{BAT} , I_{IN} and I_{OUT}) when the main charger is enabled.
- Control the TA voltage and current limit via the USB PD protocol; and main charger voltage termination, charge current and current limit.
- Send default settings.
- Read all registers displayed.
- Clear faults.

6.1 GUI Installation

The files required to install the software are available on the supplied USB drive. To install the DA9318 reference board software:

1. Run **setup_DA9318_Reference_GUI.x.x.x.xx.exe**.
2. On completion, insert the USB cable and apply V_{IN} .
 - a. For first time users Windows should detect the attached USB device. If this is not the case, it may be necessary to install the driver by navigating to the required driver file in the USB driver directory, see section 6.2. After installing the driver, reboot the PC to ensure correct operation.
3. Start the software by running **DA9318 Reference GUI.exe**.

DA9318 Direct Charging Reference Board

6.1.1 GUI Installation Step By Step Guide

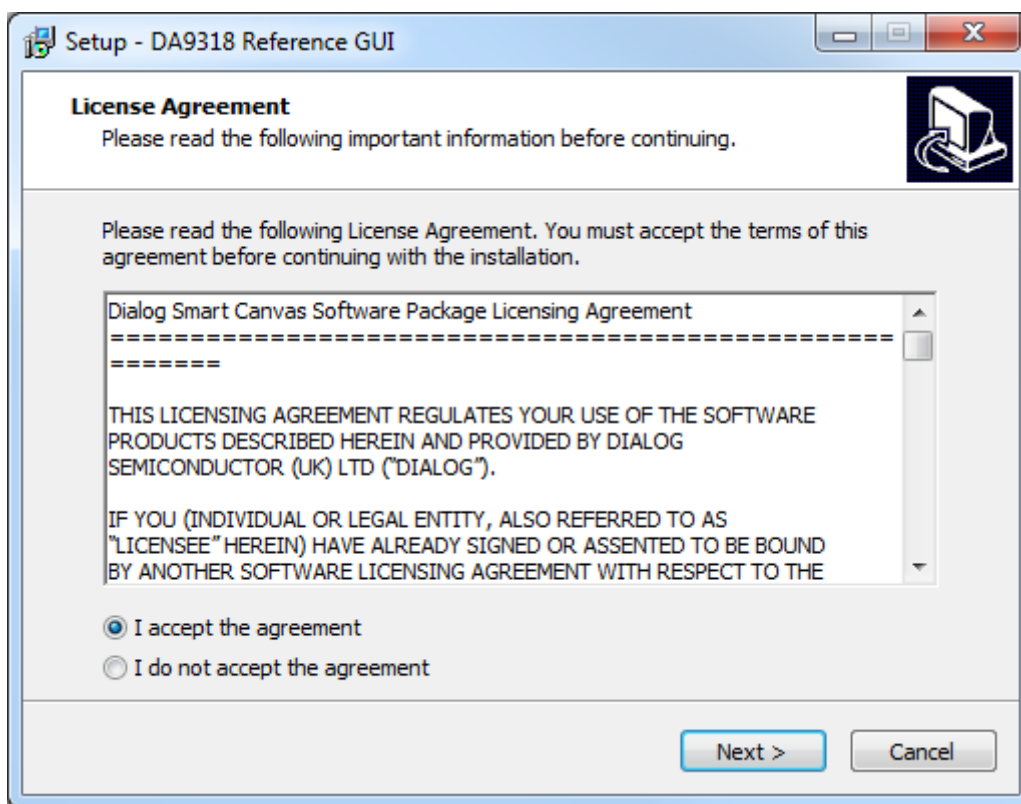

Figure 8: GUI Setup License Agreement

1. Select **I accept the agreement** then click **Next**.

DA9318 Direct Charging Reference Board

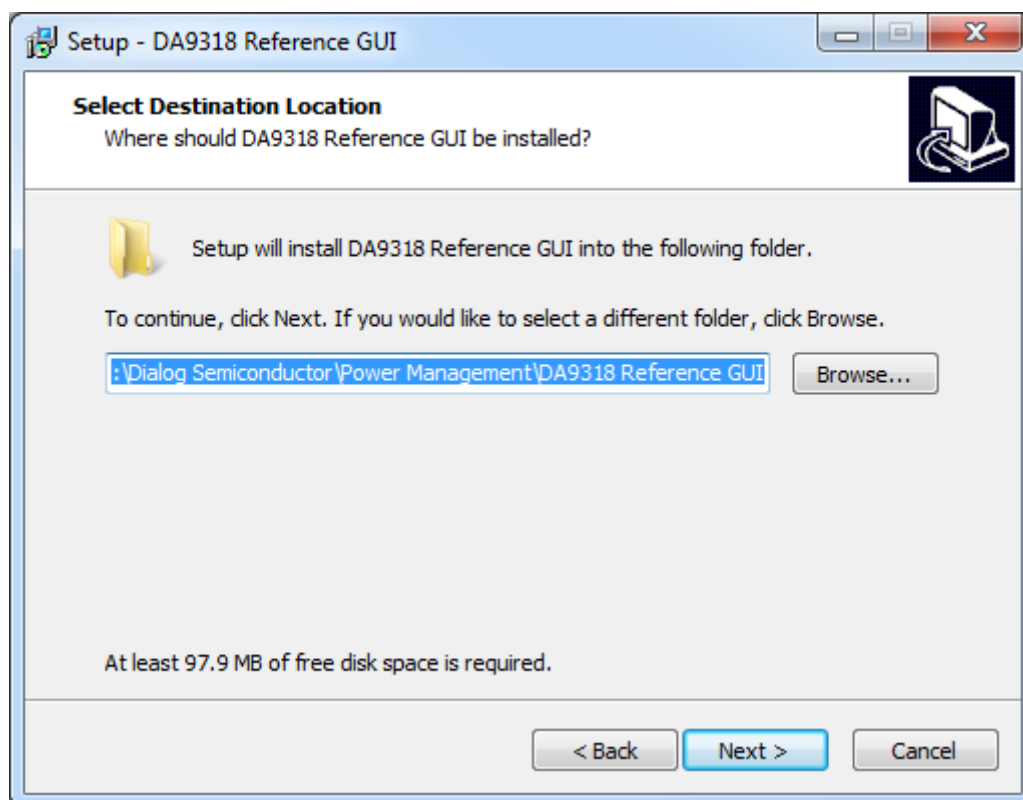

Figure 9: GUI Setup Destination Location

2. Click **Next**.

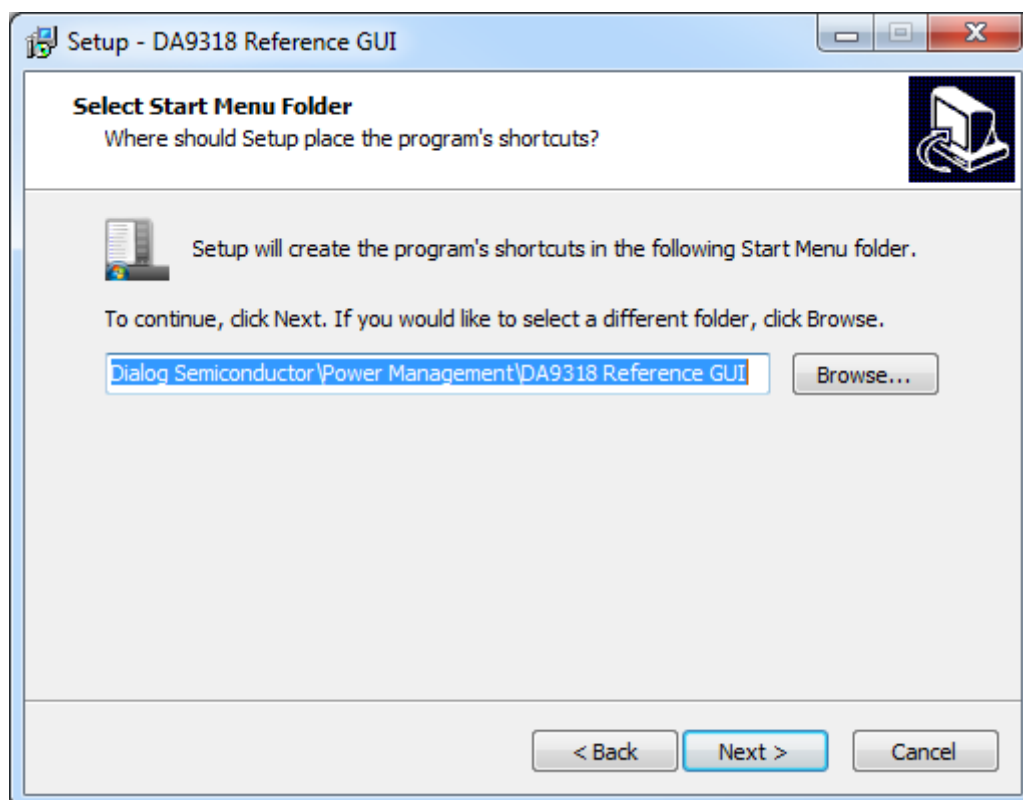

Figure 10: GUI Setup Start Menu Location

DA9318 Direct Charging Reference Board

- 3. Click **Next**.

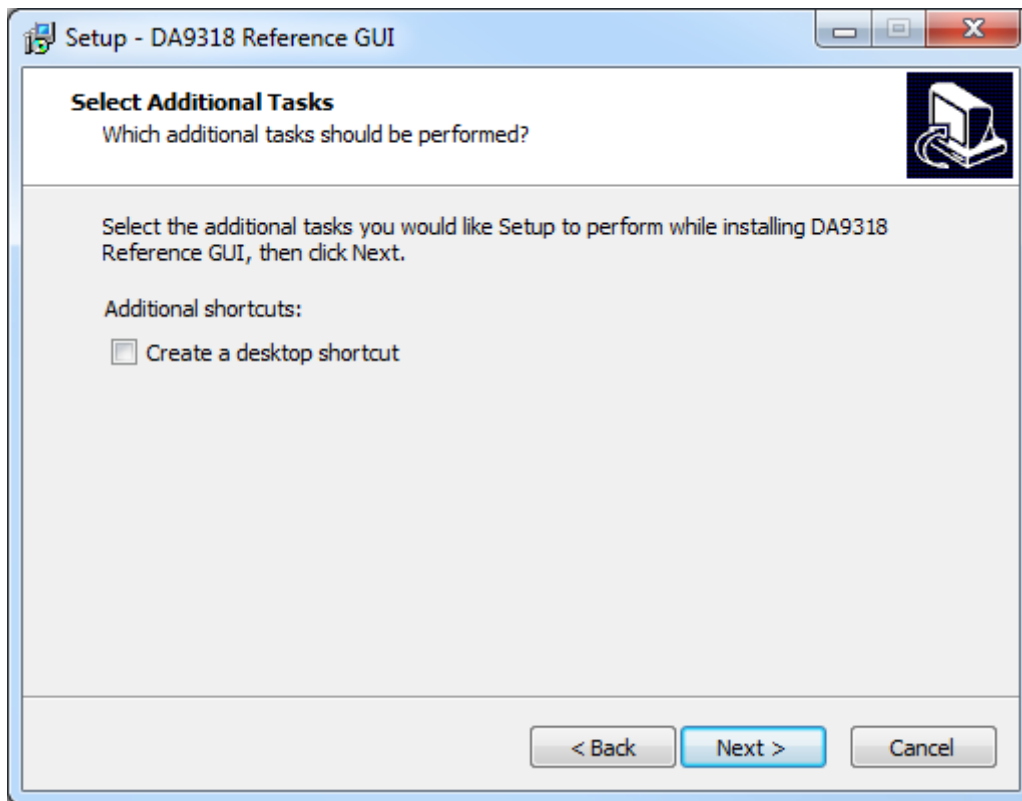

Figure 11: GUI Setup Additional Tasks

- 4. Select the **Create a desktop shortcut** check box (if required) and click **Next**.

DA9318 Direct Charging Reference Board

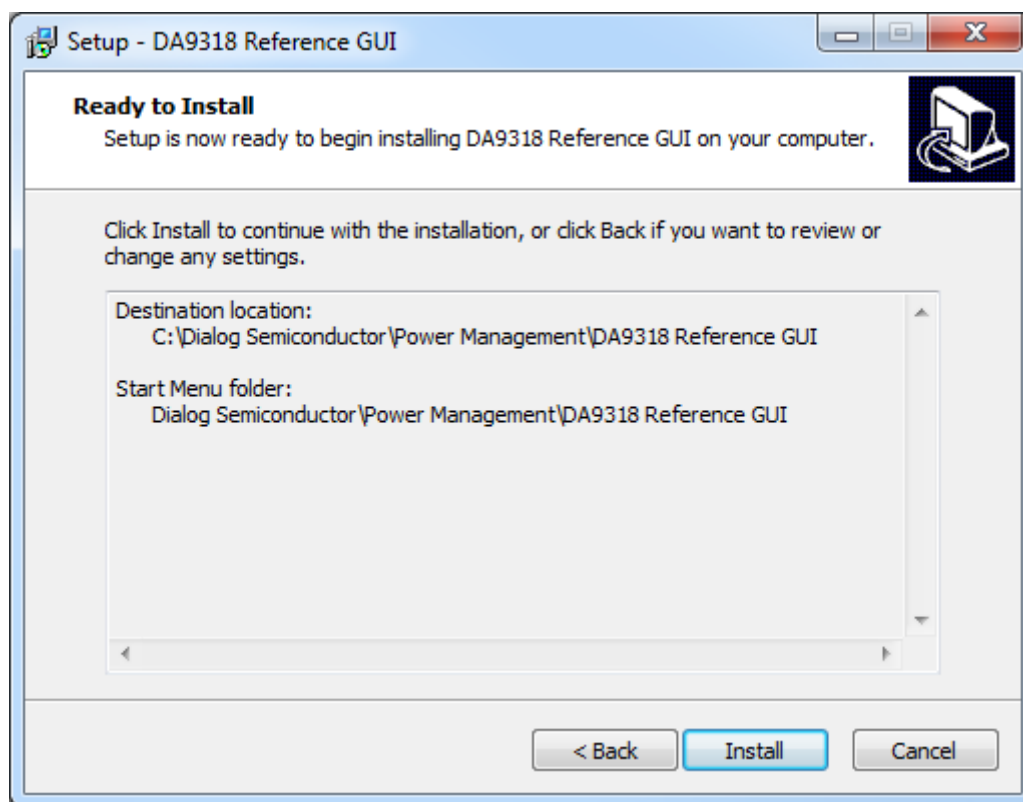

Figure 12: GUI Setup Start Installation

5. Click **Install**.



Figure 13: GUI Setup Finish and Launch

DA9318 Direct Charging Reference Board

6. Click **Finish**.

Once the installation is completed, you may need to restart your computer.

When the software is installed, insert the USB cable before applying V_{SYS} and V_{IN} . The DA9318 **SmartCanvas** software can be started after power up.

6.2 Initial USB Connection

On connecting the USB to the PC for the first time, the SAM3U USB driver will request driver updating/installation from the Windows operating system. On Windows 7 (32-bit) operating systems (OS) the driver usually installs automatically. On Windows 7 (64-bit) machines it is common for the complete driver installation to fail. If this happens, install the driver manually by following these steps:

1. **Control Panel** → **Devices and Printers** (double-click device with yellow exclamation sign).
2. **Update Driver**.
3. **Browse my computer for driver software**.
4. Select the **Driver** folder location: **C:\Dialog Semiconductor\Power Management\DA9318 Reference GUIDriver**.
5. If Windows warns about the driver, select **Install anyway**.
6. Remove the USB cable and then re-insert it into the reference board.

DA9318 Direct Charging Reference Board

7 GUI Software

Run the DA9318 Reference Board GUI software by clicking the shortcut on the appropriate item in the Start menu (**All Programs** → **Dialog Semiconductor** → **Power Management** → **DA9318 Reference GUI**). The screen shown in [Figure 14](#) is displayed.

The minimum recommended setting for the PC display size is 1024x768 pixels. Font size on the PC display should be Normal (95 dpi).

NOTE

A display size other than the recommended setting will affect the way in which the panels appear.

7.1 Controls

[Figure 14](#) shows the main GUI interface.



Figure 14: Main GUI Interface

DA9318 Direct Charging Reference Board

7.2 Control Widgets

7.2.1 Enable/Disable Polling

The polling switch enables or disables polling of the device registers and the refreshing of the registers' controls on the GUI interface.

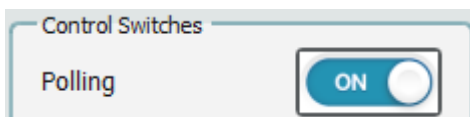

Figure 15: Polling

7.2.2 Charging Status Indicators

The **Status Indicators** window, see [Error! Reference source not found.](#), displays the following information:

- **Pre-Charge:** When the battery voltage is below 3 V (V_{BATLOW}), the battery is pre-charged at a lower charge current of 128 mA.
- **Constant-Current:** When the battery voltage is above 3 V and below the constant voltage threshold; this indicator will light green. This indicator will also light green in conjunction with the **Direct Charging** indicator during direct charger.
- **Constant-Voltage:** When the battery voltage reaches the main charger constant voltage termination voltage threshold, this indicator will light green indicating charger is in constant voltage.
- **Direct Charging:** This indicator will light green when the direct charger (DA9318) is enabled.
- **DONE:** This indicator will light green when charge cycle is complete.

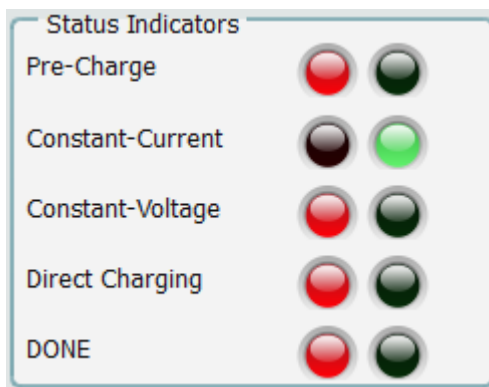

Figure 16: Charging Status Indicators

The update actions are as follows:

- **Read All Registers** – even if the hardware device is not being actively polled then all the registers can be polled once by pressing this button.

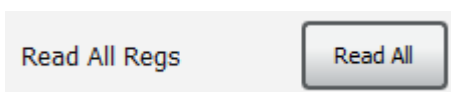

Figure 17: Read All Regs Button

DA9318 Direct Charging Reference Board

7.2.3 Charge Status Indicators

The GUI indicates the following charge statuses (assuming that the TA and the battery are both connected).

“**State = SUSPENDED**” means that the **Polling** is off.

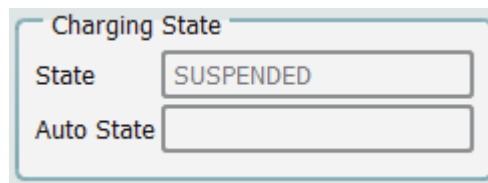

Figure 18: State = SUSPENDED

“**State = IDLE_CHARGE**” means that the **Polling** is on; the **Main Charger** and the **Direct Charger** are off.

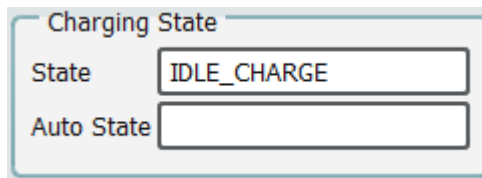

Figure 19: State = IDLE_CHARGE

“**State = MAIN_CHARGER**” means that the **Polling** is on; the **Main Charger** is on and the **Direct Charger** is off. **Auto Charge** is off.

The **Status Indicators** window displays the following charge status: **Pre-Charge**, **Constant-Current**, **Constant-Voltage**, **Direct Charging** and **DONE**.

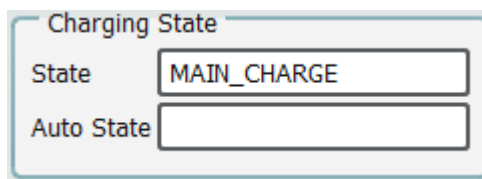

Figure 20: State = MAIN_CHARGER

“**State = ONE_SHOT_DIRECT_CHARGE**” means that the **Polling** is on; the **Main Charger** is off and the **Direct Charger** is off. **Auto Charge** is off.

The **Status Indicators** window displays the following charge status: **Pre-Charge**, **Constant-Current**, **Constant-Voltage**, **Direct Charging** and **DONE**.

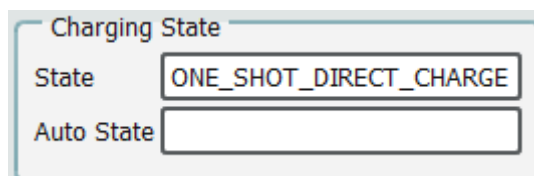

Figure 21: State = ONE_SHOT_DIRECT_CHARGE

DA9318 Direct Charging Reference Board

State = AUTO_CHARGE and **Auto State = MAIN_CHARGING** means that the Polling is on; the Auto Charge is set, the Main Charger is on and the Direct Charger is off.

The **Status Indicators** window displays the following charge status: **Pre-Charge**, **Constant-Current**, **Constant-Voltage**, **Direct Charging** and **DONE**.

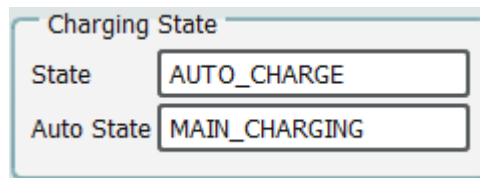

Figure 22: State = AUTO_CHARGE and Auto State = MAIN_CHARGING

State = AUTO_CHARGE and **Auto State = DIRECT_CHARGING** means that the Polling is on; the Auto Charge is set, the Main Charger is off and the Direct Charger is on.

The **Status Indicators** window displays the following charge status: **Pre-Charge**, **Constant-Current**, **Constant-Voltage**, **Direct Charging** and **DONE**.

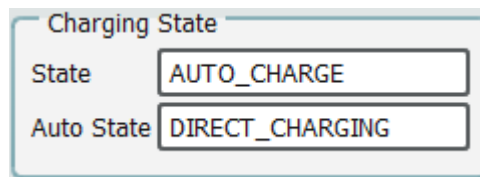

Figure 23: State = AUTO_CHARGE and Auto State = DIRECT_CHARGING

State = AUTO_CHARGE and **Auto State = END_OF_CHARGE** means that the Polling is on; the Auto Charge is set, the Main Charger is on and the Direct Charger is off.

The **Status Indicators** window displays the following charge status: **Pre-Charge**, **Constant-Current**, **Constant-Voltage**, **Direct Charging** and **DONE**.

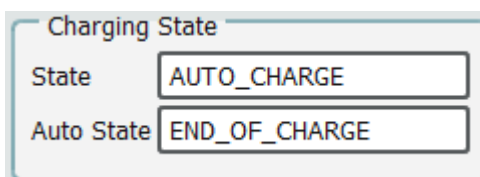

Figure 24: State = AUTO_CHARGE and Auto State = END_OF_CHARGE

DA9318 Direct Charging Reference Board

7.2.4 Raw I/O

The **Raw I/O** control sends the entered device address, register address and data on the I²C communications interface. If the information sent is not valid then the I²C message will return NACK an error message will be displayed in the **Status** window.

Figure 25: Raw I/O

7.2.5 Interface Control Information

In the **View** menu, click on **Status**, the **Status** window is displayed.

In the **Status** window, select the **Log** tab and **Log Level: Info**. This will display interface control information including: name, parent register and the bits to which this control corresponds, current value, whether it is read-only or R/W access, and finally a description of each possible setting.

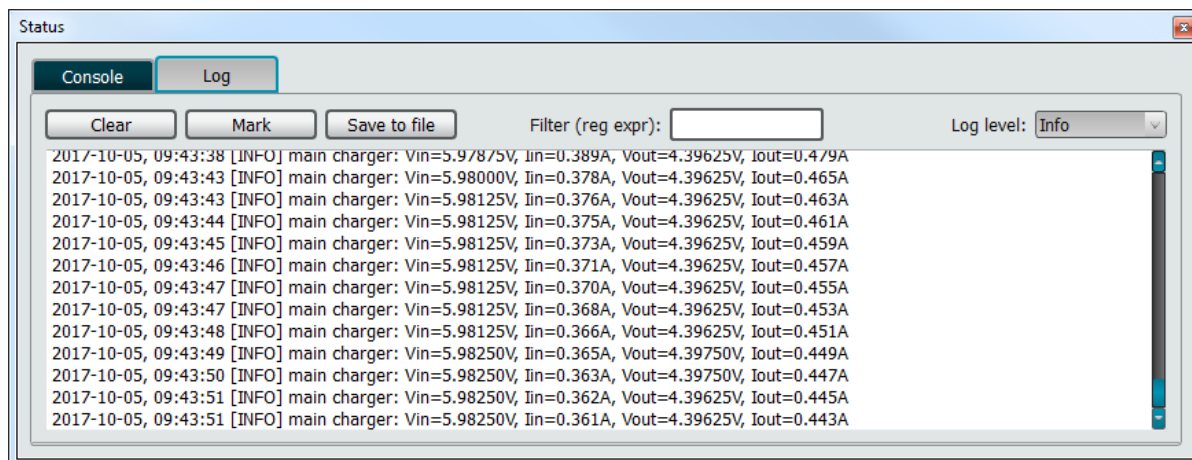

Figure 26: Interface Control Information

7.2.6 I²C Bus Scan

In the **Tools** menu, click on **Scan I2C**, the **I2C Bus Scan** window is displayed.

In the **I2C Bus Scan** window, selected **Scan**. Once the scan has completed, all I²C slave addresses will be displayed.

DA9318 Direct Charging Reference Board

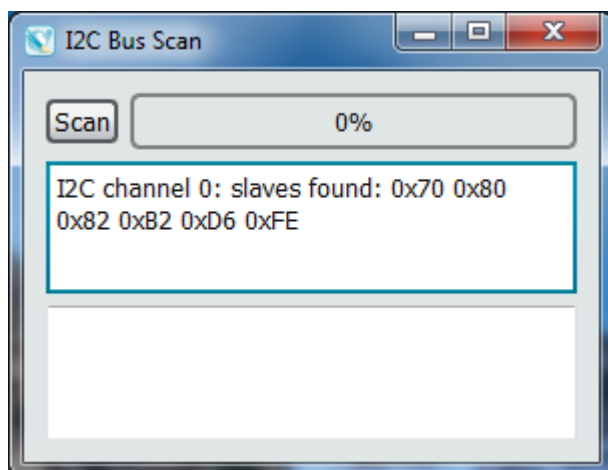

Figure 27: I2C Bus Scan

7.2.7 Settings

In the **Options** menu, click on **Settings**, the **Settings** window is displayed. The **Auto Charging** parameters can be configured in the **Settings** window.

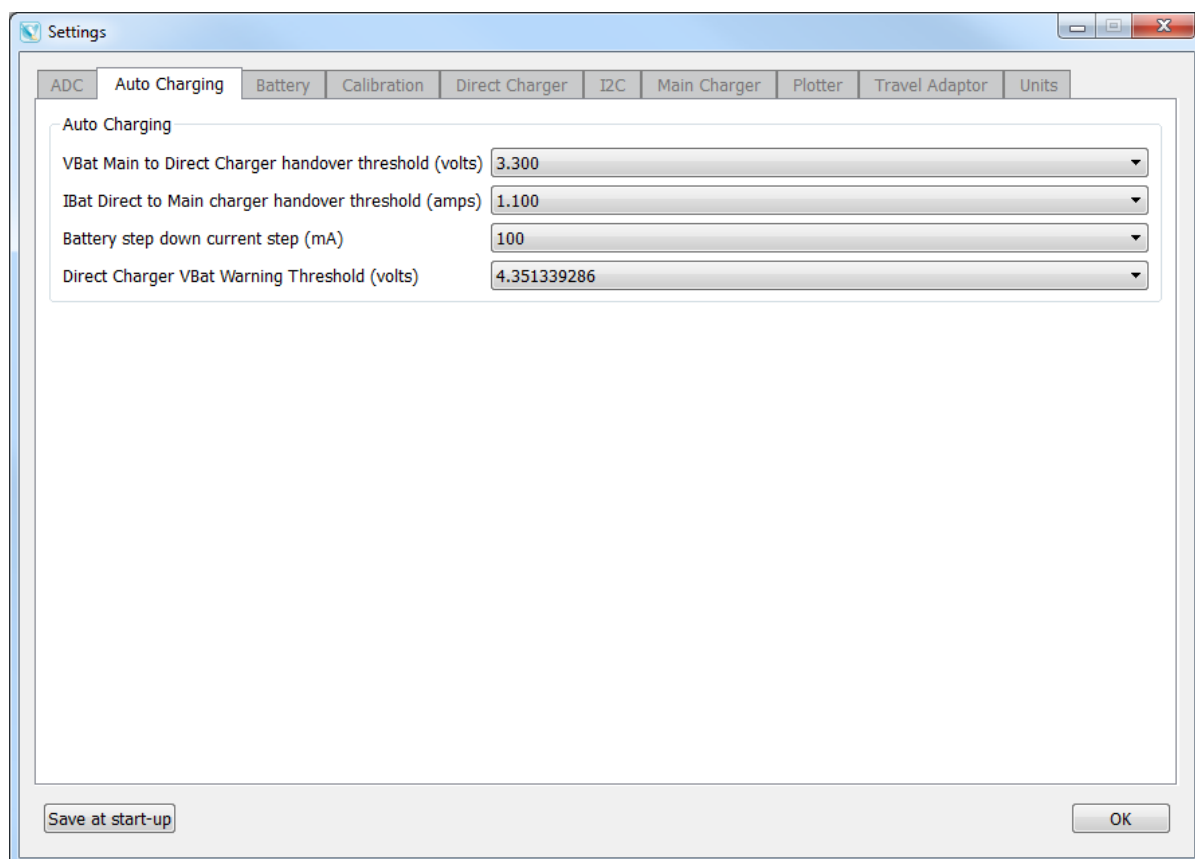

Figure 28: Settings – Auto Charging

DA9318 Direct Charging Reference Board

7.3 Quick Start Guide

7.3.1 Manual Charge Operation

The recommended steps to manually operate the DA9318 direct charging reference board are shown below.

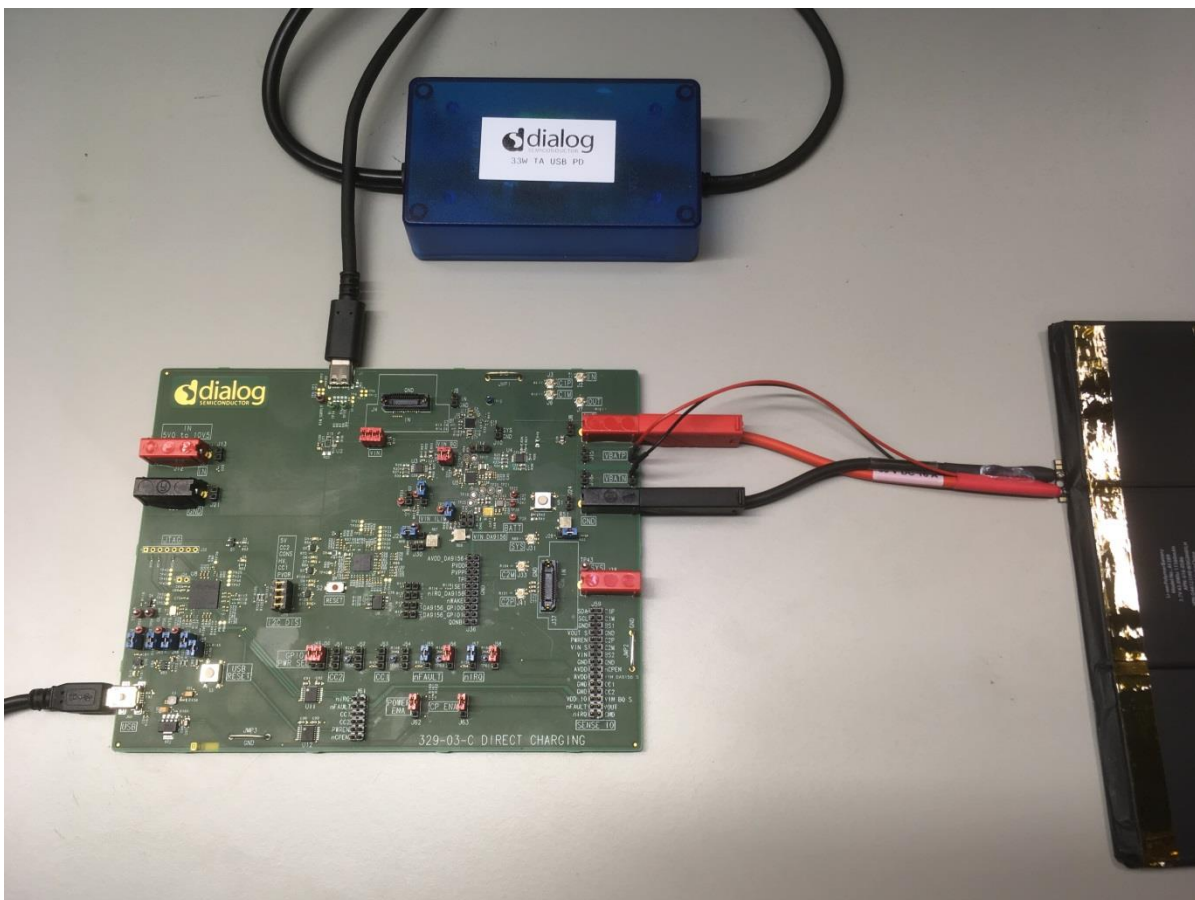
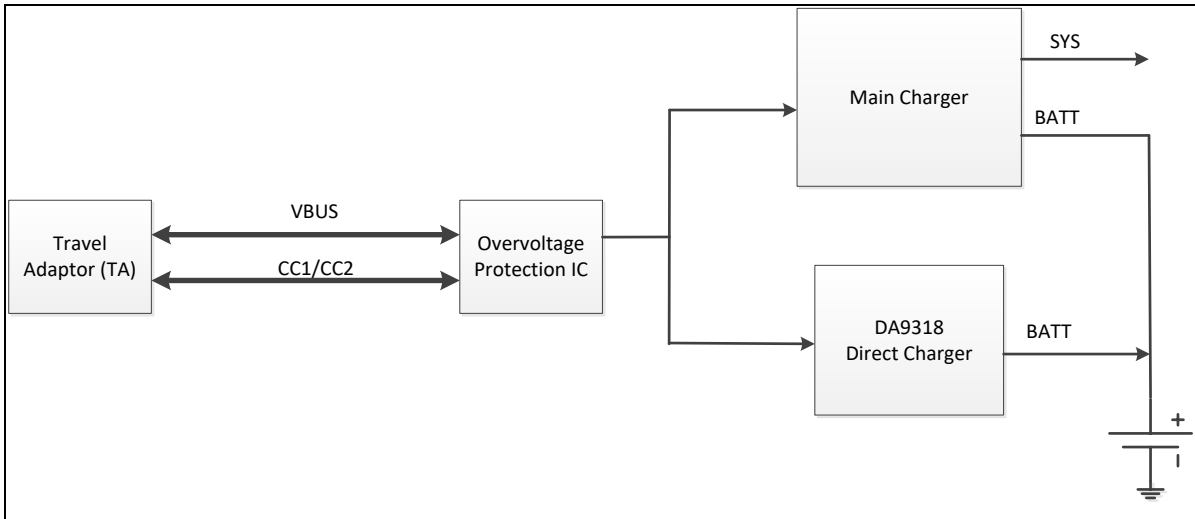

Figure 29: Test Setup (329-03-C board revision shown)

DA9318 Direct Charging Reference Board

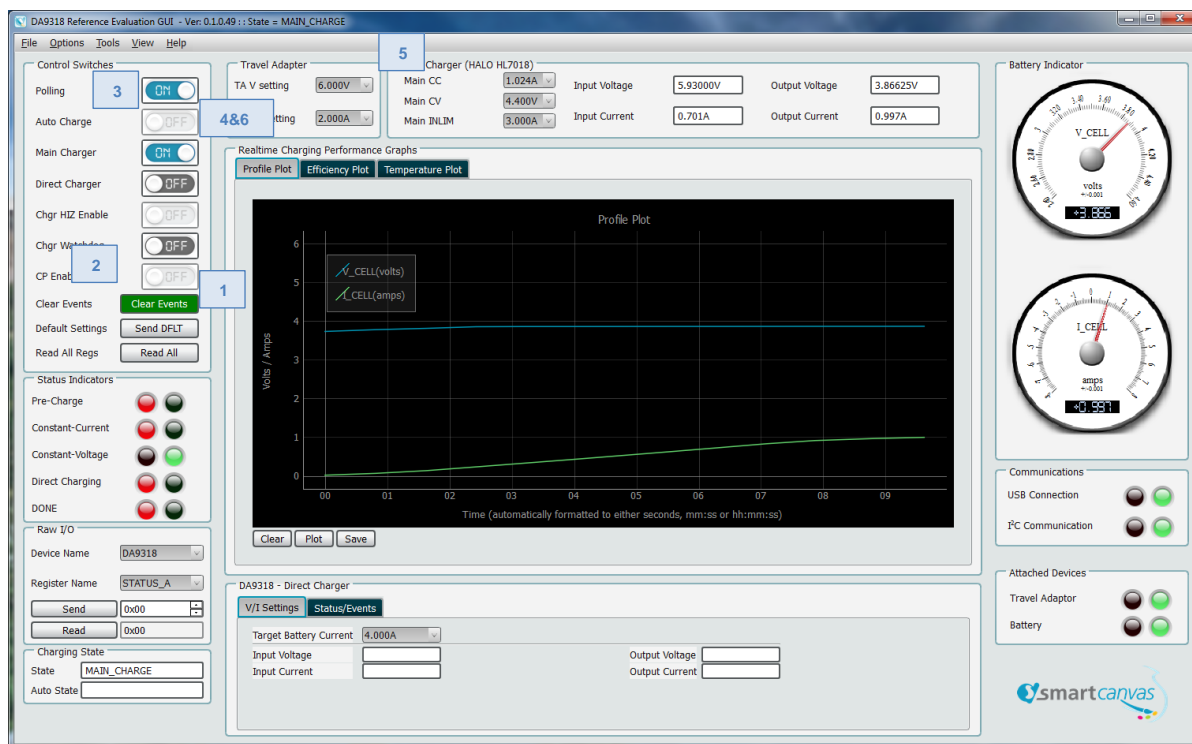

Figure 30: GUI Configuration – Manual Charge Operation

7.3.1.1 Operational Steps

The following operational steps assume that a battery is inserted initially and then the TA is inserted to J1. In addition, J60 must be connected to the USB port of a computer for I²C communication using the DA9318 Reference Board SmartCanvas GUI software.

NOTE

The battery voltage should be set to 3.1 V to allow for a 4 A initial target charge current when direct charging is enabled.

The button or status indicator locations for each operational step are highlighted in [Figure 30](#):

1. Click the **Read All** button, to read all registers to their current states.
2. Click the **No Events** button, to clear any events.
3. Click the **Main Charger** button. The **Constant-Current** status indicator flags green, signaling that the main charger is enabled.
4. Enable the **Direct Charger** switch (the **Main Charger** button auto disables). Direct charging is enabled via DA9318 and the **Constant-Current** and **Direct Charging** status indicators flag green.

NOTE

The direct charger current can then be increased up to 6 A by first increasing the **TA CC Setting** to no more than 3 A; and then by increasing the **TA V Setting** until the targeted direct charger current is reached and the TA operates in current limit.

5. When the **Constant-Voltage** status indicator flag is green, step down the **TA CC Setting** by 100 mA steps (or greater initially) until the minimum value is reached (400 mA). Note that for each step the **Constant-Voltage** status indicator will alternately flag red and green as the battery charges up.

DA9318 Direct Charging Reference Board

- When the **TA CC Setting** has reached the minimum value, disable the **Direct Charger** switch to return to main charger until the **DONE** status indicator flags green, signaling the end of the charge cycle.

NOTE

Unless the watchdog timer is serviced, it is recommended to disable it by disabling the **Chgr Watchdog** switch while the main charger is enabled.

This is to ensure that the main charger does not initiate a power-on-reset when the watchdog timer has expired. Indeed, when the watchdog timer has expired, the device returns to default mode and all registers are reset to default values.

When highlighted, clicking on the **Clear Events** switch clears all DA9318 events. When no events are flagged the switch indicates **No Events**.

DA9318 Direct Charging Reference Board

7.3.2 Automatic Charge Operation

An overview of the different charging phases is illustrated in Figure 31.

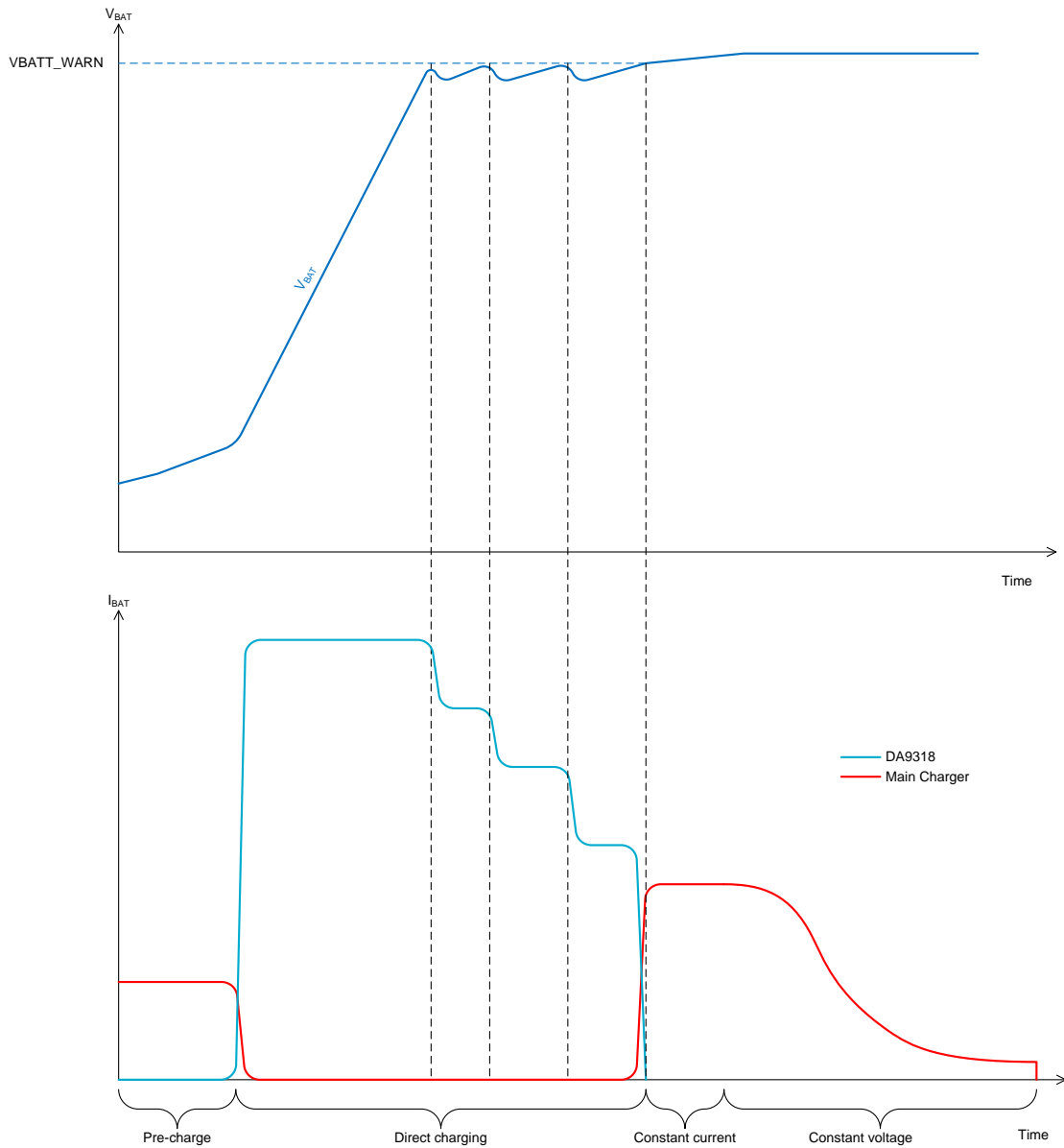

Figure 31: Overview of the Entire Charging Cycle

The recommended steps to initiate an automatic charge cycle using the DA9318 direct charging reference board are shown below.

DA9318 Direct Charging Reference Board

7.3.2.1 Customer Configuration

In the **Options** menu, click on **Settings**, the **Settings** window is displayed.

1. Select the **VBat Main to Direct Charger handover thresholds (volts)** voltage. This is the battery voltage threshold to automatically enable the direct charger. The default value is 3.3 V.
2. Select the **IBat Direct to Main Charger handover threshold (amps)** current. This is the battery current threshold to automatically switch from direct charging to main charging. The default value is 0.9 A.
3. Select the **Battery step down current step (mA)** current. This is the battery current step during the ramp down of the travel adaptor current limit. The default value is 100 mA.
4. Select the **Direct Charger VBat Warning Threshold (volts)** voltage. This is the battery voltage threshold for the assertion of the **E_VBAT_WARN** event, hence the start of the of the travel adaptor current limit reduction. The default value is 4.351339286 V that is 99 % of the **Main CV** targeted end-of-charge voltage (**Main CV** = 4.400 V by default).

In the case of a 4.2 V battery being used, **Direct Charger VBat Warning Threshold (volts)** must be set to $\sim 99\% \times 4.2\text{ V}$ (use the nearer value available in the drop down combo box) and **Main CV** must be set to 4.200 V.

NOTE

If any of the parameters are changed from their default settings, then click on the **Save at start-up** button and restart the GUI.

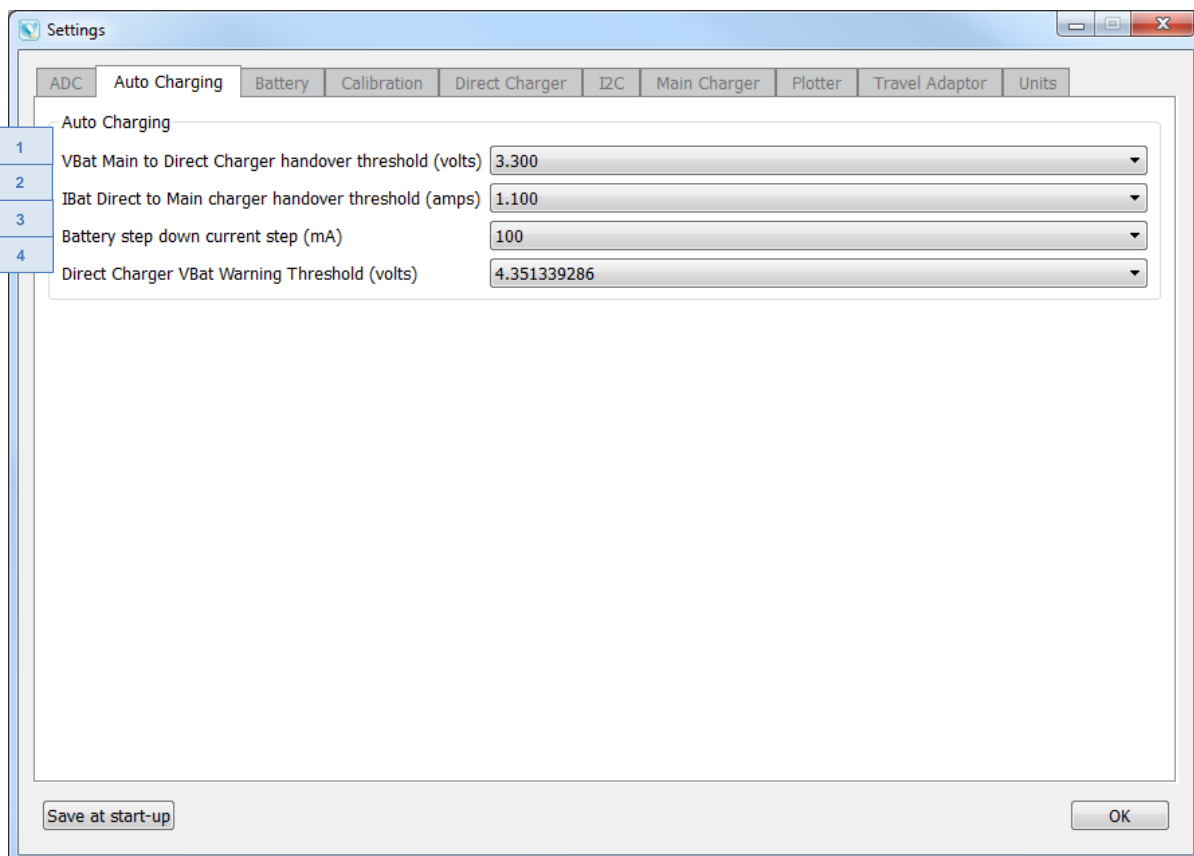

Figure 32: Settings – Auto Charging

DA9318 Direct Charging Reference Board

7.3.2.2 Operational Steps

To initiate an automatic charge cycle, one assumes that a fully discharged battery ($V_{BAT} < 2.8\text{ V}$) is inserted.

Also the TA needs to be inserted to J1 – there is no order in which the battery or TA needs to be inserted first.

In addition, J60 must be connected to the USB port of a computer for I2C communication using the DA9318 Reference Board [SmartCanvas](#) GUI software.

NOTE		
Reference Designator	Position	Function
J15	Close	Short VOUT_DA9318 to VBATP for a local pack sensing
	Open	VOUT_DA9318 and VBATP disconnected to allow cell sensing
J16	NA	VBATP connector for cell sensing
J18	Close	Short GND to VBATN for a local pack sensing
	Open	GND and VBATN disconnected to allow cell sensing
J19	NA	VBATN connector for cell sensing

Both jumpers on J15 and J18 must not be fitted. The battery +/- senses must be connected to J16 (+ sense) and J19 (- sense).

The steps to operate the automatic charge cycle are highlighted in [Figure 33](#):

1. Check out the battery charge voltage (see battery information) and set the **Main CV** accordingly.
2. As required, check out and modify the **Auto Charging** parameters in the **Options** → **Settings** window – see paragraph [7.3.2.1](#).
3. Click the **Auto Charge** button, to start the automatic charge cycle.

The charge cycle (i.e. plotting the battery voltage and charge current) is shown by the **Profile Plot** of the **Real-time Charging Performance Graphs**.

The main charger and DA9318 efficiency is shown by the **Efficiency Plot**; whereas the DA9318 die temperature is shown by the **Temperature Plot**.

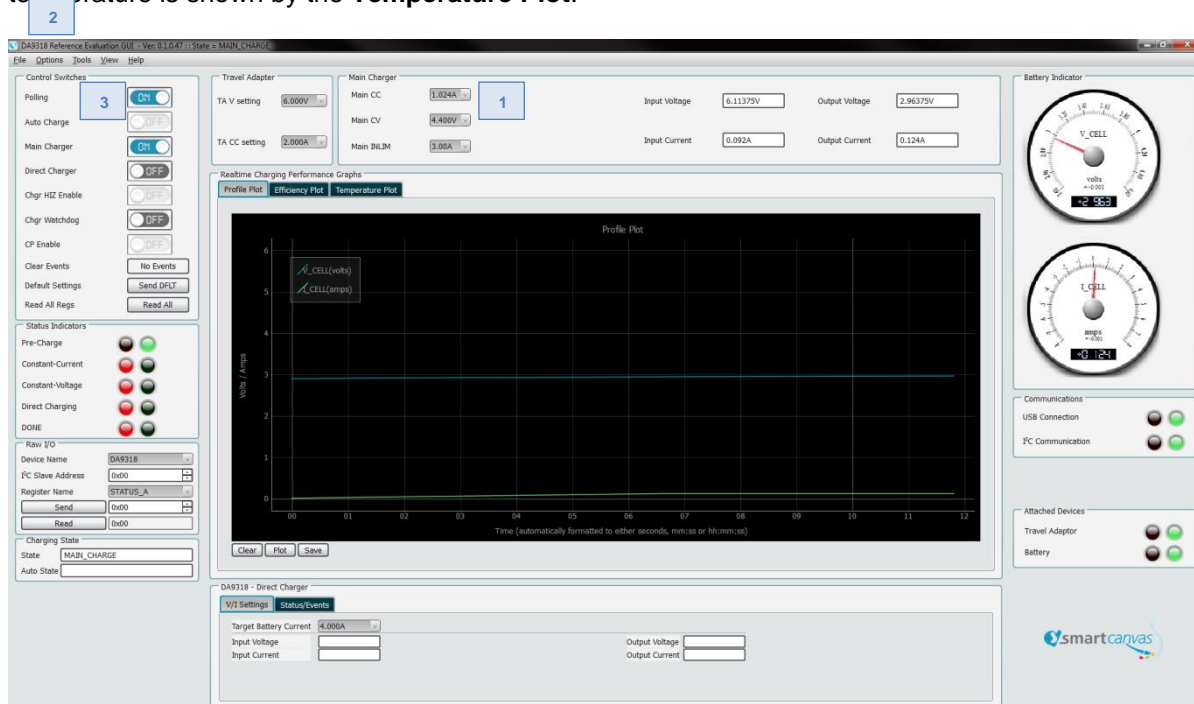

Figure 33: GUI Configuration – Automatic Charge Operation

DA9318 Direct Charging Reference Board

NOTE

The target charge current can be increased or decreased by setting the new target in the **Target Battery Current** field prior to enabling the **Auto Charge**.

When the **Auto Charge** is set the settings cannot be changed on the fly. All changes made to any settings will be ignored until a new charge is initiated.

7.3.2.3 Charge Cycles Examples

Example #1: 3.7 V 11560 mAh/43 Wh Tablet Battery

Figure 34 shows the automatic charge cycle of a 3.7 V 11560 mAh/43 Wh tablet battery.

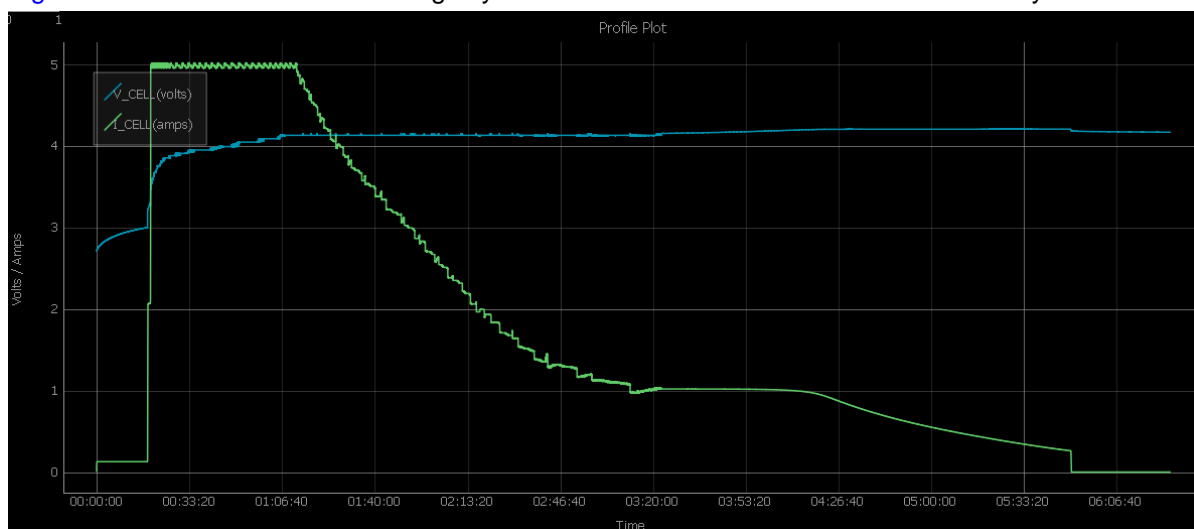

Figure 34: Automatic Charge Cycle – Profile Plot – 11560 mAh Battery

The test conditions are shown here below:

- **Main CC** = 2.048 A
- **Main CV** = 4.208 V
- **Target Battery Current** = 5.000 A
- **VBat Main to Direct Charger handover thresholds (volts)** = 3.3 V
- **IBat Direct to Main Charger handover threshold (amps)** = 1.1 A
- **Battery step down current step (mA)** = 100 mA
- **Direct Charger VBat Warning Threshold (volts)** = 4.157589286 V

NOTE

In **Auto Mode** the **Target Battery Current** for the 11560 mAh battery can be set to 5.500 A maximum.

Initially the main charger is in pre-charge (128 mA by default) until the battery voltage reaches 3 V (default threshold set in the main charger's registers).

Then, the main charger enters fast charge with a fast charge current arbitrarily set to 1.024 A.

Once the handover battery voltage threshold is reached to enter direct charging; the main charger is disabled and the DA9318 is enabled with a target battery charge current of 5.5 A.

Upon assertion of the **E_VBAT_WARN** event, the TA current is reduced allowing for a smaller charge current; then the **E_VBAT_WARN** event is reset.

Every time the **E_VBAT_WARN** event is flagged up the TA steps down its current limit setting accordingly by yet another current step.

DA9318 Direct Charging Reference Board

When the charge current reaches a handover charge current threshold (arbitrarily set to 0.9 A) the DA9318 is switched off and the main charger is enabled and finishes off the charge cycle.

The main charger continues its fast charge and voltage regulation phase until the termination current is reached where the main charger will get disabled.

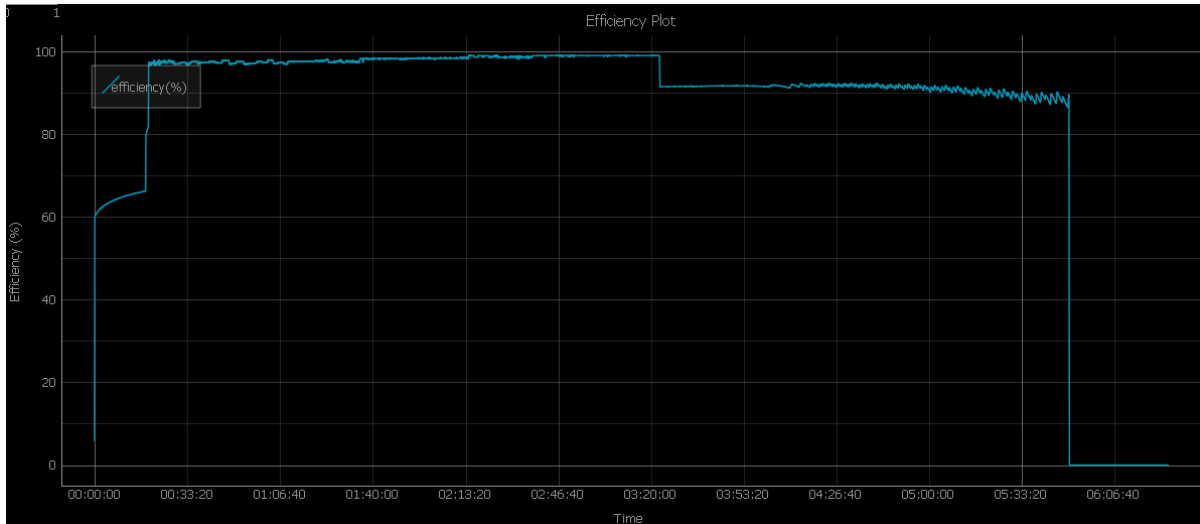

Figure 35: Automatic Charge Cycle – Efficiency Plot – 11560 mAh Battery

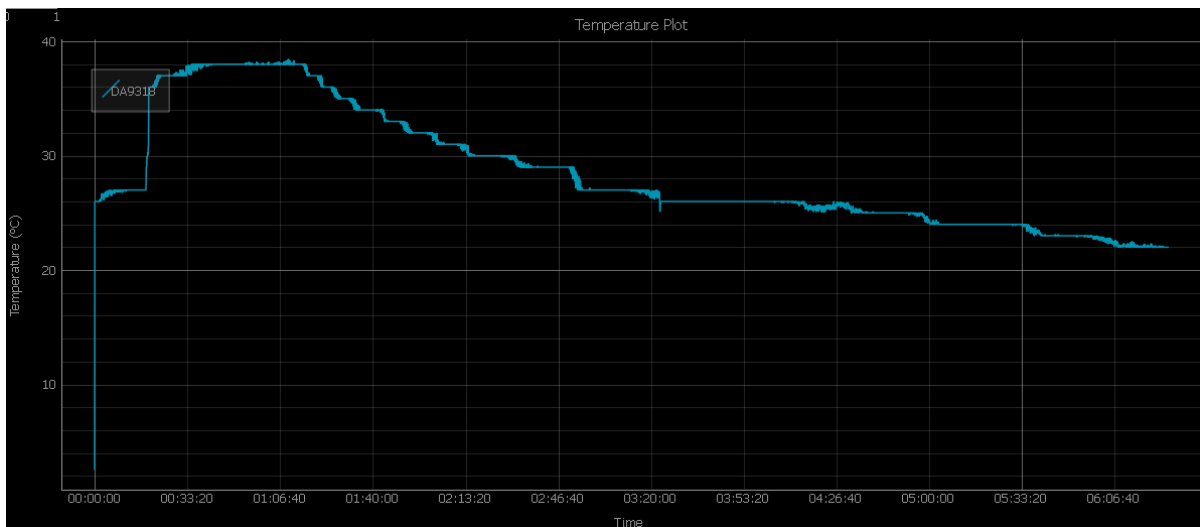

Figure 36: Automatic Charge Cycle – Temperature Plot – 11560 mAh Battery

DA9318 Direct Charging Reference Board

Example #2: 3.7 V 3600 mAh/13.86 Wh Mobile Phone Battery

Figure 37 shows the automatic charge cycle of a 3.7 V 3600 mAh/13.86 Wh mobile phone battery.

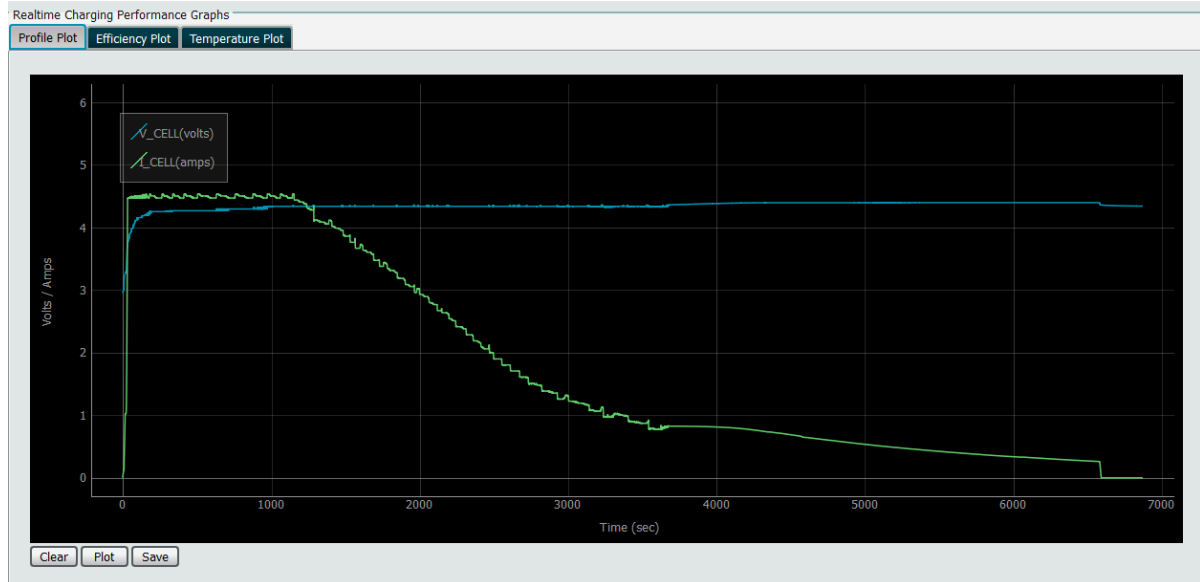

Figure 37: Automatic Charge Cycle – Profile Plot – 3600 mAh Battery

The test conditions are shown here below:

- **Main CC** = 1.024 A
- **Main CV** = 4.400 V
- **Target Battery Current** = 4.500 A
- **VBat Main to Direct Charger handover thresholds (volts)** = 3.3 V
- **IBat Direct to Main Charger handover threshold (amps)** = 0.9 A
- **Battery step down current step (mA)** = 100 mA
- **Direct Charger VBat Warning Threshold (volts)** = 4.351339286 V

NOTE

In **Auto Mode** the **Target Battery Current** for the 3600 mAh battery can be set to 5.000 A maximum.

DA9318 Direct Charging Reference Board

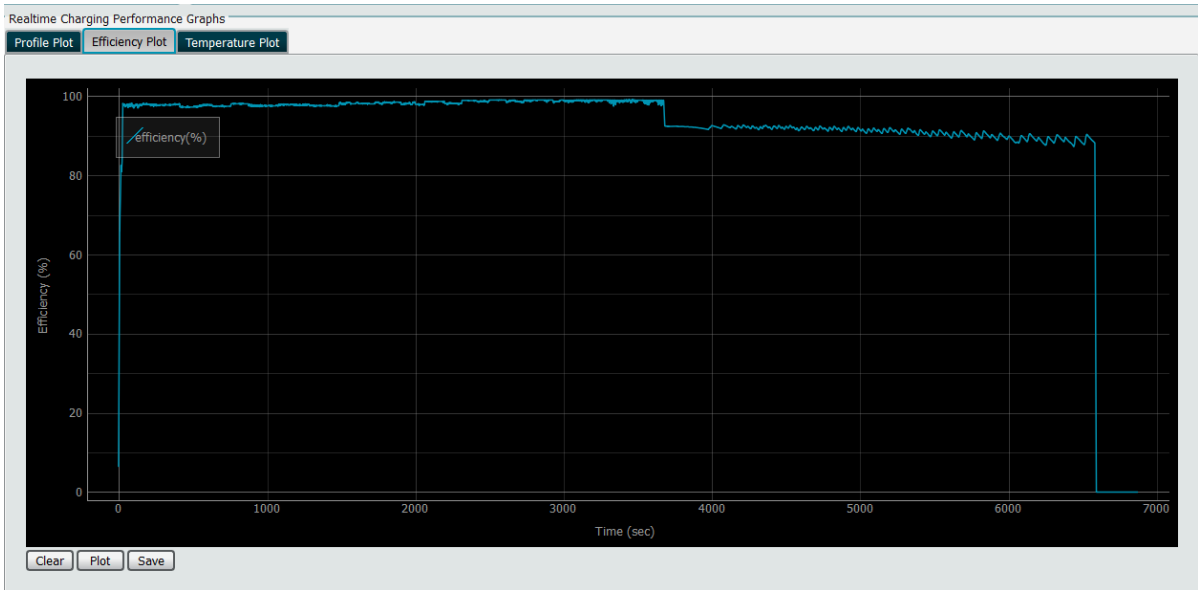

Figure 38: Automatic Charge Cycle – Efficiency Plot – 3600 mAh Battery

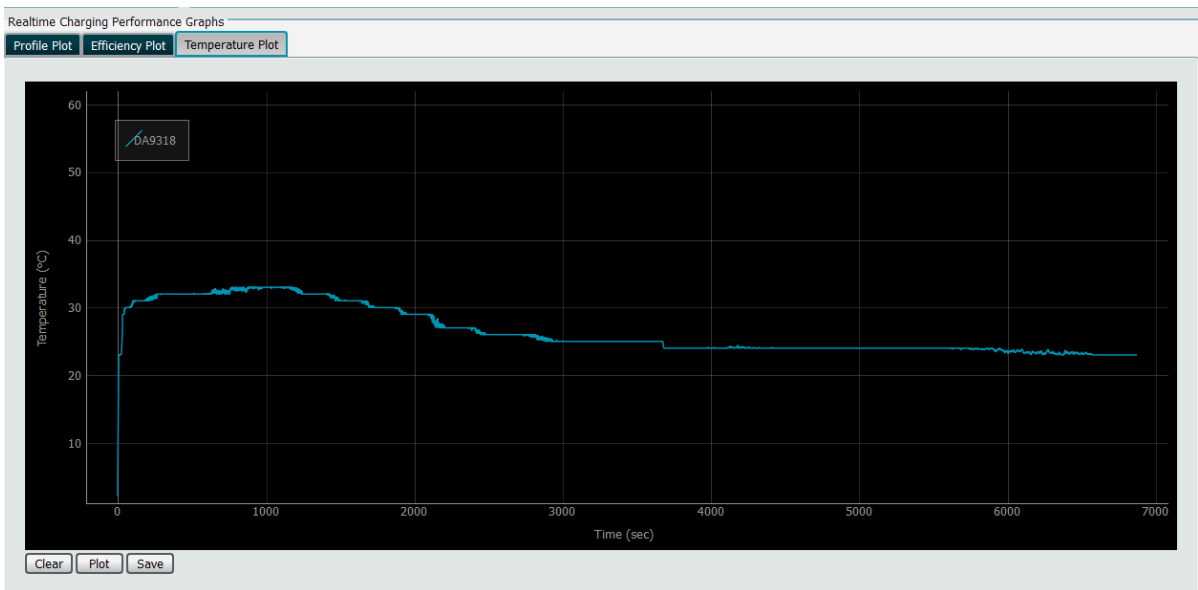

Figure 39: Automatic Charge Cycle – Temperature Plot – 3600 mAh Battery

DA9318 Direct Charging Reference Board

Revision History

Revision	Date	Description
1.0	01-Mar-2017	Initial version.
2.0	19-Jul-2017	USP PD implemented. New 329-03-C board and GUI.
3.0	28-Nov-2017	Added automatic charge cycle section.
3.1	23-Jul-2018	Main charger changed to Halo Micro's HL7018. Board revision changed to 329-03-D.
3.2	16-Feb-2022	Document rebranded to Renesas.

DA9318 Direct Charging Reference Board

Status Definitions

Status	Definition
DRAFT	The content of this document is under review and subject to formal approval, which may result in modifications or additions.
APPROVED or unmarked	The content of this document has been approved for publication.

DA9318 Direct Charging Reference Board

Important Notice and Disclaimer

RENESAS ELECTRONICS CORPORATION AND ITS SUBSIDIARIES ("RENESAS") PROVIDES TECHNICAL SPECIFICATIONS AND RELIABILITY DATA (INCLUDING DATASHEETS), DESIGN RESOURCES (INCLUDING REFERENCE DESIGNS), APPLICATION OR OTHER DESIGN ADVICE, WEB TOOLS, SAFETY INFORMATION, AND OTHER RESOURCES "AS IS" AND WITH ALL FAULTS, AND DISCLAIMS ALL WARRANTIES, EXPRESS OR IMPLIED, INCLUDING, WITHOUT LIMITATION, ANY IMPLIED WARRANTIES OF MERCHANTABILITY, FITNESS FOR A PARTICULAR PURPOSE, OR NON-INFRINGEMENT OF THIRD PARTY INTELLECTUAL PROPERTY RIGHTS.

These resources are intended for developers skilled in the art designing with Renesas products. You are solely responsible for (1) selecting the appropriate products for your application, (2) designing, validating, and testing your application, and (3) ensuring your application meets applicable standards, and any other safety, security, or other requirements. These resources are subject to change without notice. Renesas grants you permission to use these resources only for development of an application that uses Renesas products. Other reproduction or use of these resources is strictly prohibited. No license is granted to any other Renesas intellectual property or to any third party intellectual property. Renesas disclaims responsibility for, and you will fully indemnify Renesas and its representatives against, any claims, damages, costs, losses, or liabilities arising out of your use of these resources. Renesas' products are provided only subject to Renesas' Terms and Conditions of Sale or other applicable terms agreed to in writing. No use of any Renesas resources expands or otherwise alters any applicable warranties or warranty disclaimers for these products.

© 2022 Renesas Electronics Corporation. All rights reserved.

(Rev.1.0 Mar 2020)

Corporate Headquarters

TOYOSU FORESIA, 3-2-24 Toyosu

Koto-ku, Tokyo 135-0061, Japan

www.renesas.com

Contact Information

For further information on a product, technology, the most up-to-date version of a document, or your nearest sales office, please visit:

<https://www.renesas.com/contact/>

Trademarks

Renesas and the Renesas logo are trademarks of Renesas Electronics Corporation. All trademarks and registered trademarks are the property of their respective owners.

IMPORTANT NOTICE AND DISCLAIMER

RENESAS ELECTRONICS CORPORATION AND ITS SUBSIDIARIES (“RENESAS”) PROVIDES TECHNICAL SPECIFICATIONS AND RELIABILITY DATA (INCLUDING DATASHEETS), DESIGN RESOURCES (INCLUDING REFERENCE DESIGNS), APPLICATION OR OTHER DESIGN ADVICE, WEB TOOLS, SAFETY INFORMATION, AND OTHER RESOURCES “AS IS” AND WITH ALL FAULTS, AND DISCLAIMS ALL WARRANTIES, EXPRESS OR IMPLIED, INCLUDING, WITHOUT LIMITATION, ANY IMPLIED WARRANTIES OF MERCHANTABILITY, FITNESS FOR A PARTICULAR PURPOSE, OR NON-INFRINGEMENT OF THIRD-PARTY INTELLECTUAL PROPERTY RIGHTS.

These resources are intended for developers who are designing with Renesas products. You are solely responsible for (1) selecting the appropriate products for your application, (2) designing, validating, and testing your application, and (3) ensuring your application meets applicable standards, and any other safety, security, or other requirements. These resources are subject to change without notice. Renesas grants you permission to use these resources only to develop an application that uses Renesas products. Other reproduction or use of these resources is strictly prohibited. No license is granted to any other Renesas intellectual property or to any third-party intellectual property. Renesas disclaims responsibility for, and you will fully indemnify Renesas and its representatives against, any claims, damages, costs, losses, or liabilities arising from your use of these resources. Renesas' products are provided only subject to Renesas' Terms and Conditions of Sale or other applicable terms agreed to in writing. No use of any Renesas resources expands or otherwise alters any applicable warranties or warranty disclaimers for these products.

(Disclaimer Rev.1.01)

Corporate Headquarters

TOYOSU FORESIA, 3-2-24 Toyosu,
Koto-ku, Tokyo 135-0061, Japan
www.renesas.com

Trademarks

Renesas and the Renesas logo are trademarks of Renesas Electronics Corporation. All trademarks and registered trademarks are the property of their respective owners.

Contact Information

For further information on a product, technology, the most up-to-date version of a document, or your nearest sales office, please visit www.renesas.com/contact-us/.