

RTKA489118DE0000BU, RTKA489118DE0010BU

The RTKA489118DE0000BU and RTKA489118DE0010BU evaluation boards evaluate the performance of the RAA489118. The default value numbers of maximum and minimum output voltages, autonomous charging mode, and the adapter current limit charging function can be programmed by the resistor from the PROG pin to GND. The values can also be set by SMBus.

The [RAA489118](#) is a buck-boost charger supporting 30V input and 30V battery. The RAA489118 provides charging and protection features for power tools, portable vacuums, battery-powered lawn mowers, power banks, and additional system bus regulation for notebooks. It also supports any USB-C interface platform including USB PD EPR. The advanced Renesas R3™ technology provides highly efficient light-load operation and fast transient response.

In Charging mode, the RAA489118 accepts input power from a wide range of DC power sources (such as conventional AC/DC charger adapters, USB PD ports, and travel adapters) and safely charges battery packs with up to 7 serially connected battery cells up to 30V. The device can operate with only a battery, only an adapter, or with both connected.

The RAA489118 supports reverse buck, reverse boost, or reverse buck-boost operation to the input port from 2-cell to 7-cell batteries.

The RAA489118 provides programming resistor options including autonomous charging, max output voltages, adapter current limit. Additionally, it provides serial communication that enables programming of many critical parameters to deliver a customized solution.

Features

- Buck-boost charger for 2 to 7-cell up to 30V batteries
- Optional BFET
- Autonomous charging option (automatic completion of charging)
- Pass-through mode in forward direction
- Trickle charging of depleted battery
- Adapter current and battery current monitor (AMON/BMON)
- Reverse buck, boost, and buck-boost operation from battery
- Battery Ship mode option
- SMBus and auto-increment I²C compatible

Specifications

- V_{IN} = 3.9V to 30V (no dead zone)
- V_{OUT} = 2.4V to 30.8V
- MAX I_{charge} up to 6A (R_{S2} = 10m Ω), 12A (R_{S2} = 5m Ω by default)
- f_{SW} = 732kHz (default)

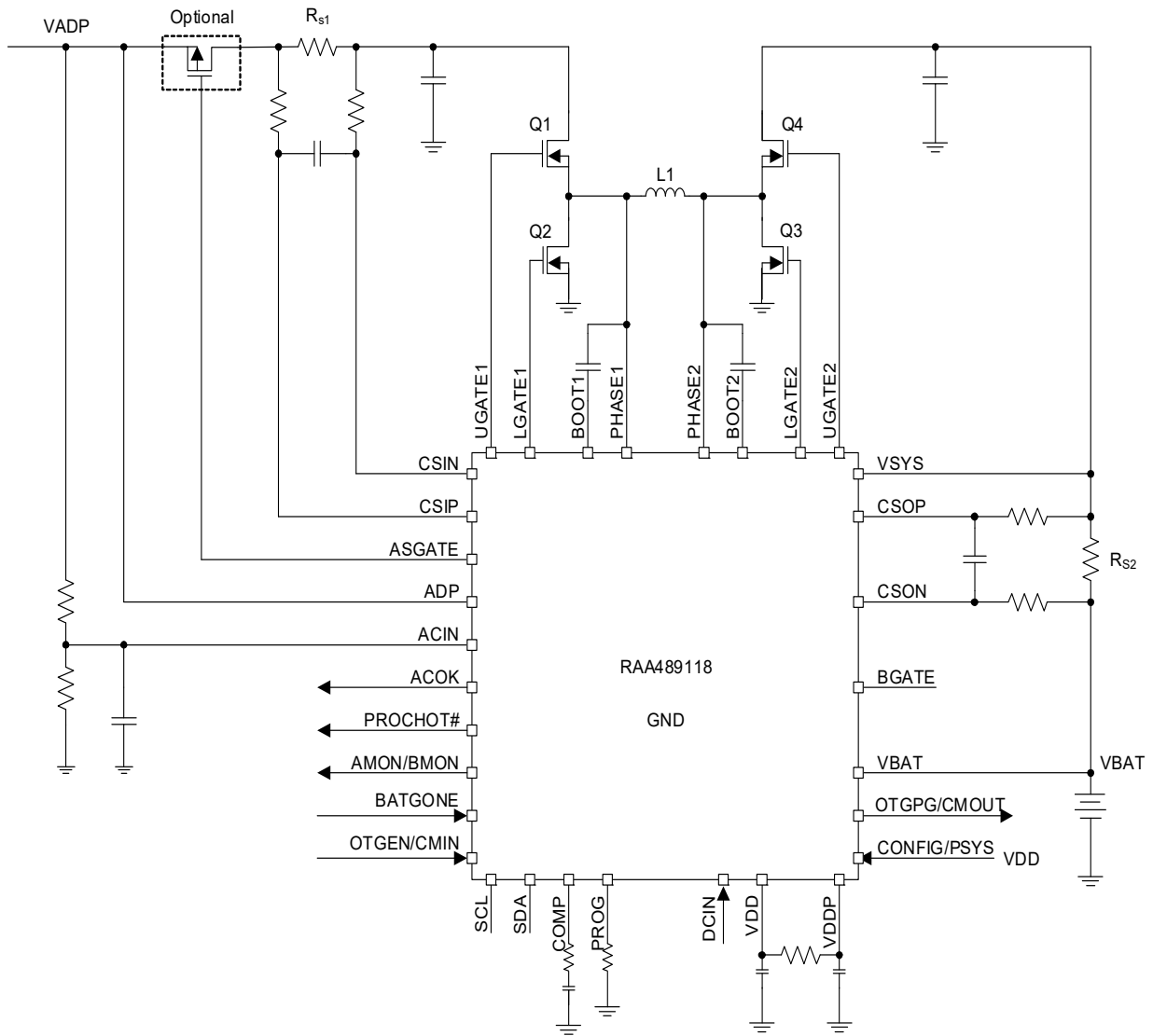

Figure 1. Typical Application Circuit #1 (Battery Charging Only with No BFET, RTKA489118DE000BU)

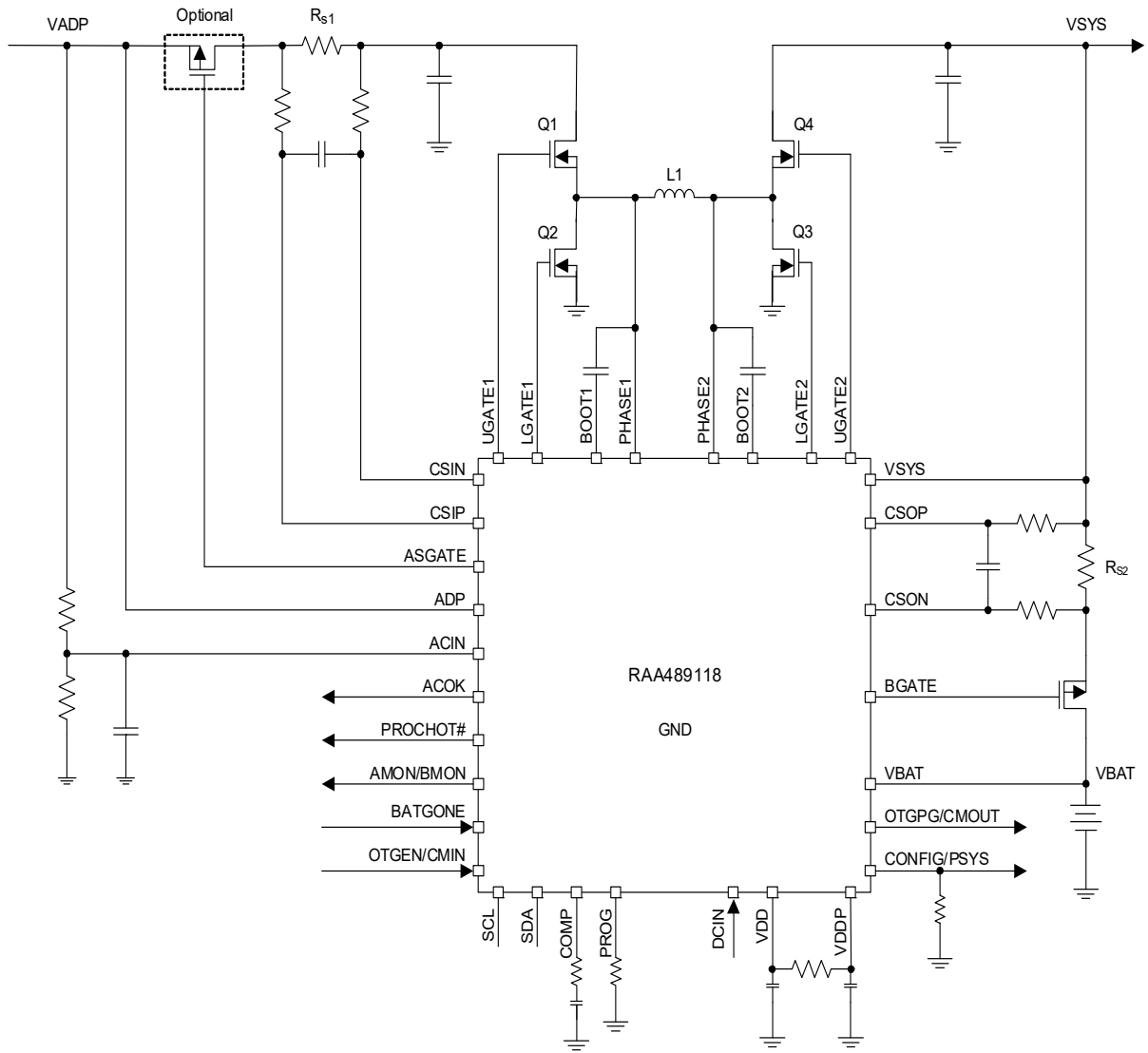

Figure 2. Typical Application Circuit #2 (Battery Charging Only with a BFET, RTKA489118DE0010BU)

Contents

1. Functional Description	5
1.1 Recommended Equipment	5
1.2 Quick Start Guide	5
2. Board Design	9
2.1 Layout Guidelines	11
2.2 Schematic Diagrams	14
2.3 Bill of Materials	15
2.4 Board Layout	22
3. Typical Performance Graphs	24
3.1 Battery Charging Only (No BFET)	24
3.2 NVDC Charging (with BFET)	26
4. Ordering Information	28
5. Revision History	28

1. Functional Description

The RTKA489118DE0000BU and RTKA489118DE0010BU provide all the circuits required to evaluate the features of the RAA489118. A majority of the features of the RAA489118, such as the adjustable output voltage, Trickle Charging mode for depleted battery, and the system power monitor at Buck, Boost, and Buck-Boost modes are available on this evaluation board.

1.1 Recommended Equipment

- 0V to 35V power supply with at least 6A source current capability
- Electronic load capable of sinking current up to 6A
- Battery emulator capable of sinking and sourcing current up to 6A
- Digital Multimeters (DMMs)
- 100MHz quad-trace oscilloscope

Note: A power supply (that can source current but cannot sink current) can be used in parallel with an e-load Constant Current (CC) mode to emulate the battery. For example, to charge, set the charging current command lower than the CC mode e-load. If the e-load CC mode current is set to 3A, the charge current command is 2A, and the e-load draws 2A from the charger and draws another 1A from the power supply in parallel with it. To discharge, the power supply acts like the battery to discharge current. The e-load Constant Voltage (CV) mode can also be used to emulate the battery to take the charging current from the charger and set the e-load CV voltage below the MaxSysV register setting; however, this e-load CV mode cannot source current like a battery.

1.2 Quick Start Guide

The number of battery cell and adapter current limit default values can be configured through SW3 to select a proper PROG R. The PROG Pin Programming Options table in the *RAA489118 Datasheet* shows the programming options. After the default number of cells in series is set, the default values for MaxSystemVoltage and MinSystemVoltage are set accordingly. These values can also be changed through the SMBus control registers in the Renesas GUI, shown in [Figure 3](#).

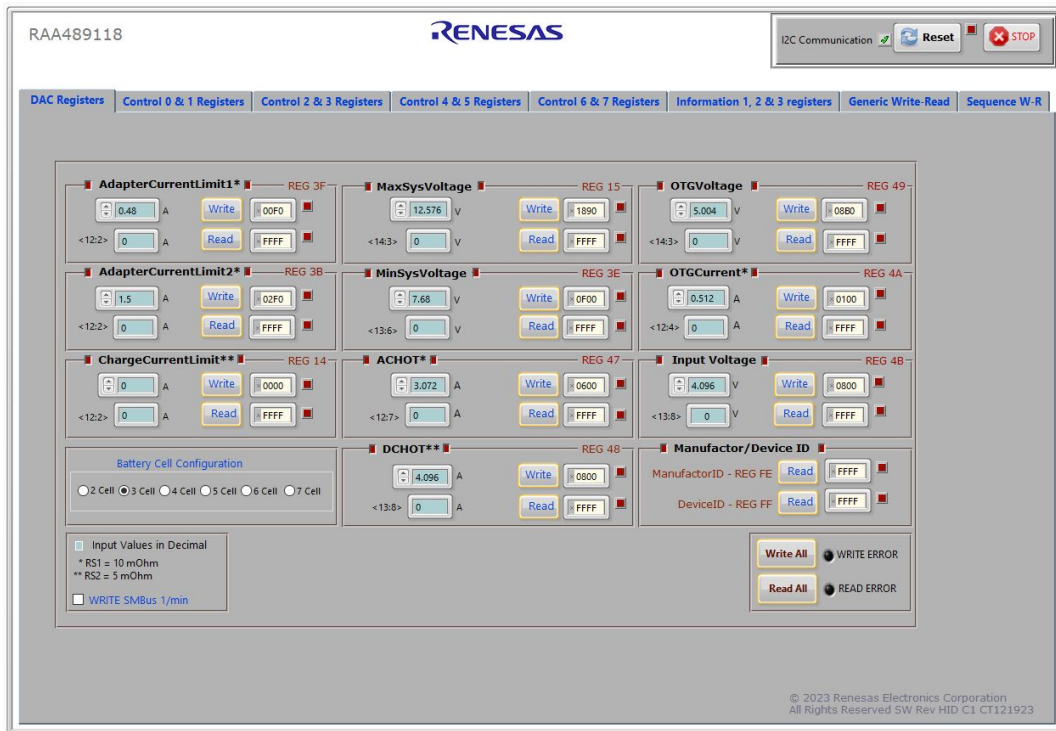

Figure 3. GUI Snapshot

The three LEDs indicate the ACOK, PROCHOT, and CMOUT status, respectively. For more details about the functions of these three pins, refer to the *RAA489118 Datasheet*. Figure 4 shows the top view of the evaluation board and highlights the key testing points and connection terminals. For more information about the RAA489118, including other modes of operation, refer to the *RAA489118 Datasheet*.

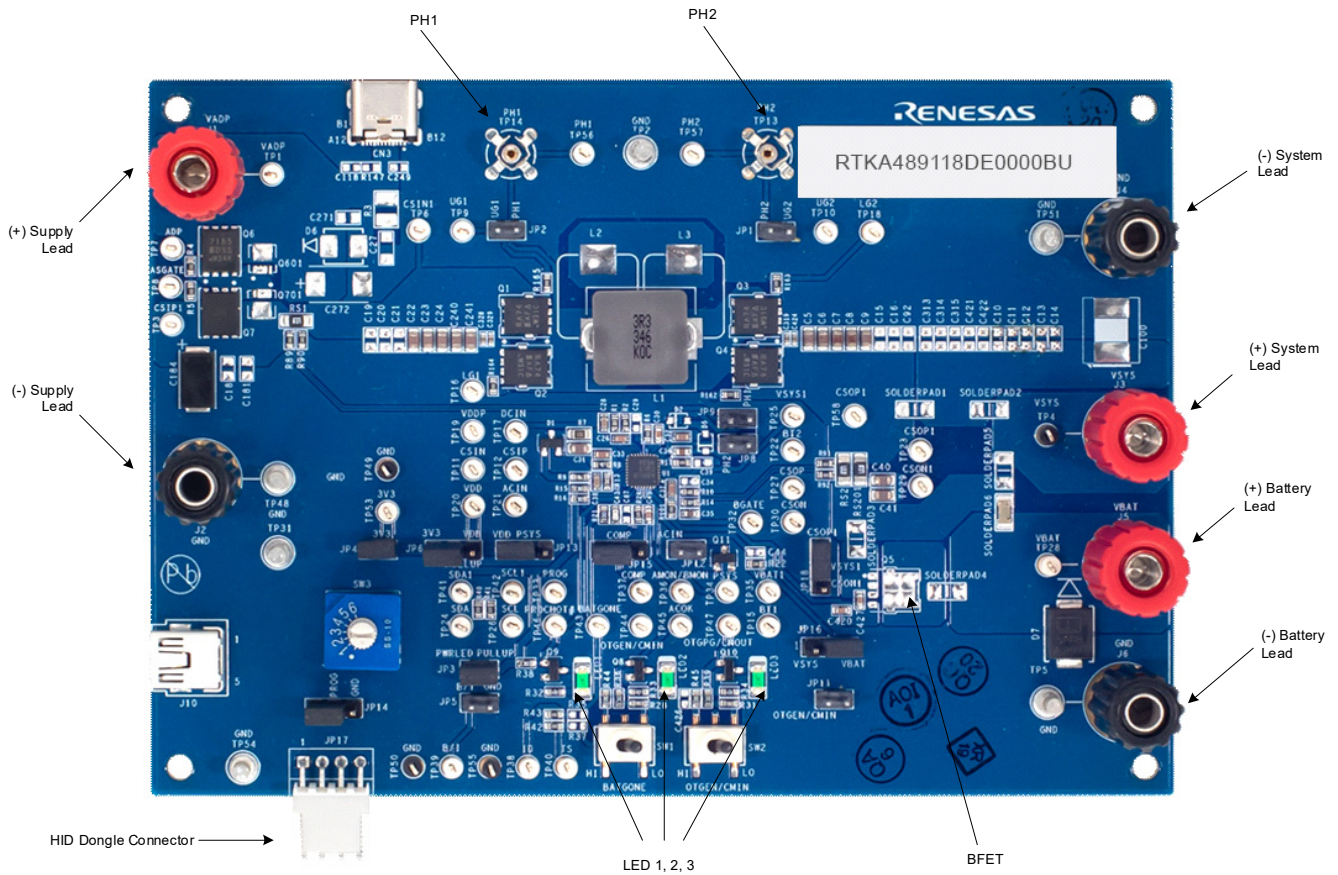

Figure 4. Evaluation Board Connection Guideline

Complete the following steps to evaluate the RAA489118 key functions for each of two different configurations below:

- With No BFET configuration – Input current limit regulation, Charging mode, Trickle Charging mode, and OTG mode.
- With BFET configuration – System voltage regulation, input current limit regulation, Charging mode, and Trickle Charging mode.

1.2.1 Without BFET Configuration (RTKA489118DE000BU)

1.2.1.1 Input Current Limit Regulation

1. Set SW3 to the position-4 for 5 cell BAT setting. Ensure all the jumper connections. SW1 and SW2 should switch to the LO position.
2. Connect the HID dongle cable with proper wiring connections for the I2C communication.
3. Set the battery emulator voltage to 18.5V and connect the battery emulator output to battery leads J5 and J6. Turn on the battery emulator and open the RAA489118 GUI (shown in Figure 3).

Note: A green check mark in the **I2C Communication** section of the GUI indicates the GUI is ready to communicate with the evaluation board. A red X in the **I2C Communication** section indicates the GUI is not ready

to communicate with the evaluation board. Click the **Reset** button until a green check mark shows in the **I2C Communication**. If a green check mark does not appear, verify the HID dongle connection.

- Click the **Read All** button and check the **AdapterCurrentLimit1**, **ChargeCurrentLimit**, **MaxSysVoltage**, and **MinSysVoltage** values. With the SW3 to position-4 configuration, the values should be **AdapterCurrentLimit1** = 0.48A, **ChargeCurrentLimit** = 0.256A, **MaxSysVoltage** = 21.0V, and **MinSysVoltage** = 12.8V.
- Set the power supply to 5V. Disable the output and connect the (+) end to J1 and the (-) end to J2.
- Turn on the power supply. The current meter on the supply should read 0.48A. *Note:* Although the **ChargeCurrentLimit** is 0.256A, the current meter on battery emulator cannot reach at 0.256A and can be limited by the **AdapterCurrentLimit1**, considering VIN and battery emulator voltage.

1.2.1.2 Charging Mode

- Complete all the steps in [Input Current Limit Regulation](#).
- Slowly increase VIN from 5V to 28V. Monitor PH1 and PH2 to observe seamless switching from Boost mode to Buck-Boost mode, and finally into Buck mode. The current meter on the battery emulator should read 0.256A.
- Set the **AdapterCurrentLimit1** to 5A and click the **Write** button and check the read value through the **Read** button. The adapter current limit is now 5A.
- Set the **ChargeCurrentLimit** to 2A and click the **Write** button and check the read value through the **Read** button. The current meter on the battery emulator should read 2A. The charge current value can be monitored in the GUI by clicking the **Read** button in the ChargeCurrentLimit section.
- If the RS1 and RS2 values are different from the RS1 = 10mΩ and RS2 = 5mΩ option, scale the SMBus commands accordingly to obtain the correct current. Smaller current sense resistor values reduce the power loss and larger current sense resistor values give better accuracy.

1.2.1.3 Trickle Charging Mode

- Complete all the steps in [Charging Mode](#) without any changes.
- Decrease the battery emulator voltage and monitor the battery charging current. If the battery emulator voltage is less than 12.8V (lower than **MinSysVoltage**), the battery enters trickle Charging mode and the charge current decreases to 512mA. The trickle charge current value can be changed through the SMBus control registers. Refer to the *RAA489118 Datasheet* for more information.

1.2.1.4 OTG Mode

- Set the battery emulator voltage at a constant value between 5.8V and 21V. Connect battery leads J5 and J6 with the output disabled.
- Connect an electric load on supply leads J1 and J2 with the output disabled.
- Connect the HID dongle cable with proper wiring connections for the I2C communication.
- Turn on the battery emulator and electrical load without adding any load.
- Open the RAA489118 GUI. OTGVoltage at register 0x49 is the voltage value for the load side, and OTGCurrent at register 0x4A is the OTG output current limit at the load side. You can set these values as needed within the output limit range. Refer to the RAA489118 datasheet for the limit ranges.
- Select the Control0 & 1 Registers tab. In the Control1 Register column, select 1: Enable in OTG Function (Bit 11) to enable OTG, then click Write. The load voltage is regulated as an OTGVoltage value, set in step 4.
- Increase the electrical load slowly and monitor the load voltage. If the load current is less than the OTGCurrent limit value, the load voltage is regulated at the setting value.

Note: The test procedure for OTG Mode with BFET Configuration is the same as [OTG Mode](#) without BFET Configuration.

1.2.2 With BFET Configuration (RTKA489118DE0010BU)

1.2.2.1 System Voltage Regulation

1. Set the power supply to 5V. Disable the output and connect the (+) end to J1 and the (-) end to J2.
2. Set SW3 to the position-4 for 5 cell BAT setting. Ensure all the jumper connections. SW1 and SW2 should switch to the LO position.
3. Turn on the power supply and measure the output voltage (VSYS) using the DMM across (+) and (-) TP5. VSYS should read 21.0V for 5 cell. The current meter on the supply should read <100mA. Slowly increase VIN from 5V to 28V. Monitor PH1 and PH2 to observe seamless switching from Boost mode to Buck-Boost mode, and finally into Buck mode.

1.2.2.2 Input Current Limit Regulation

1. Complete all the steps in [System Voltage Regulation](#).
2. Set the battery emulator voltage to 18.5V and connect the battery emulator output to battery leads J5 and J6. Turn on the battery emulator; there is no charge and discharge current for the battery, which is consistent with the BGATE signal of a high voltage level.
3. Add an electrical load on VSYS and GND terminals J3 and J4. Turn on the load and increase the electrical load slowly; the input current increases correspondingly and VSYS keeps stable at 21.0V. VSYS starts dropping as the input current reaches the 0.48A input current limit. Refer to the *RAA489118 Datasheet* for more information about the input current limit. If the VSYS voltage is 150mV lower than the battery voltage, the BGATE FET turns on at a low voltage level so that the battery supplies the current to the load.

1.2.2.3 Charging Mode

1. Complete all the steps in [System Voltage Regulation](#).
2. Set the battery emulator voltage to 18.5V and connect the battery emulator output to battery leads J5 and J6.
3. Connect the HID dongle cable with proper wiring connections for the **I2C communication**.
4. Turn on the power supply. Turn on the battery emulator and open the RAA489118 GUI (shown in [Figure 3](#)).
Note: A green check mark in the **I2C Communication** section of the GUI indicates the GUI is ready to communicate with the evaluation board. A red X in the **I2C Communication** section indicates the GUI is not ready to communicate with the evaluation board. Click the **Reset** button until a green check mark shows in the **I2C Communication**. If a green check mark does not appear, verify the HID dongle connection.
5. Click the **Read All** button and check the **AdapterCurrentLimit1**, **ChargeCurrentLimit**, **MaxSysVoltage**, and **MinSysVoltage** values. With the SW3 to position-4 configuration, the values should be **AdapterCurrentLimit1** = 0.48A, **ChargeCurrentLimit** = 0.256A, **MaxSysVoltage** = 21.0V, and **MinSysVoltage** = 12.8V.
6. Set the AdapterCurrentLimit1 to 5A and click the **Write** button and check the read value through the **Read** button. The adapter current limit is now 5A.
7. Change the **ChargeCurrentLimit** from 0A to 2A and click the **Write** button. The battery is now in a 2A current charge configuration. The charge current value can be monitored in the GUI by clicking the **Read** button in the ChargeCurrentLimit section. Monitor the BGATE signal status to confirm that the battery is in Charging mode.
8. If the RS1 and RS2 values are different from the RS1 = 10mΩ and RS2 = 5mΩ option, scale the SMBus commands accordingly to obtain the correct current. Smaller current sense resistor values reduce the power loss and larger current sense resistor values give better accuracy.

1.2.2.4 Trickle Charging Mode

1. Complete steps all the steps in [Charging Mode](#) without any changes.
2. Decrease the battery emulator voltage and monitor the battery charging current. If the battery emulator voltage is less than 12.8V (lower than **MinSysVoltage**), the battery enters trickle Charging mode and the charge

current decreases to 512mA. The trickle charge current value can be changed through the SMBus control registers. Refer to the *RAA489118 Datasheet* for more information.

Note: Make sure the input current does not reach the input current limit value, especially for small VIN input.

2. Board Design

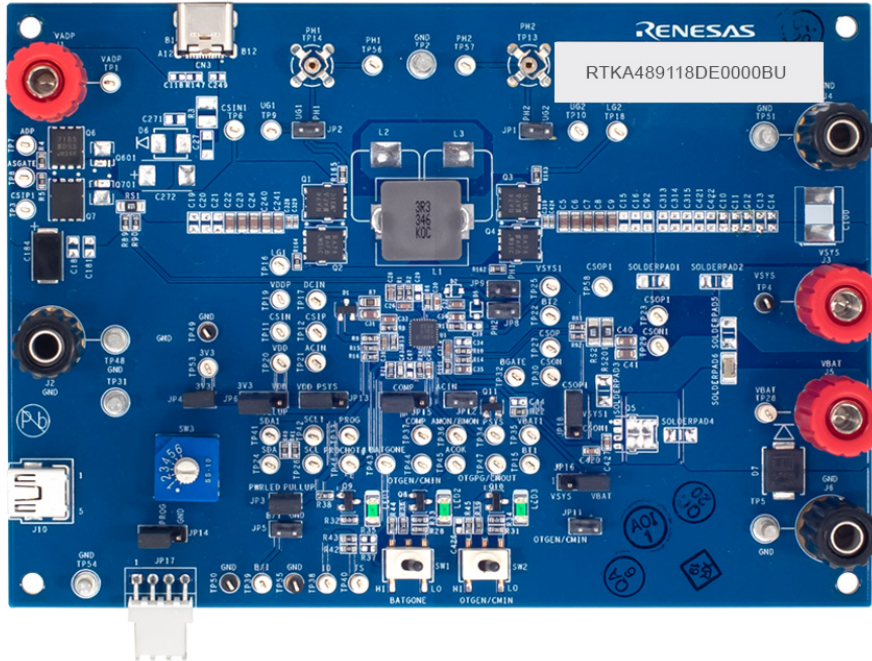

Figure 5. RTKA489118DE0000BU Evaluation Board (Top)

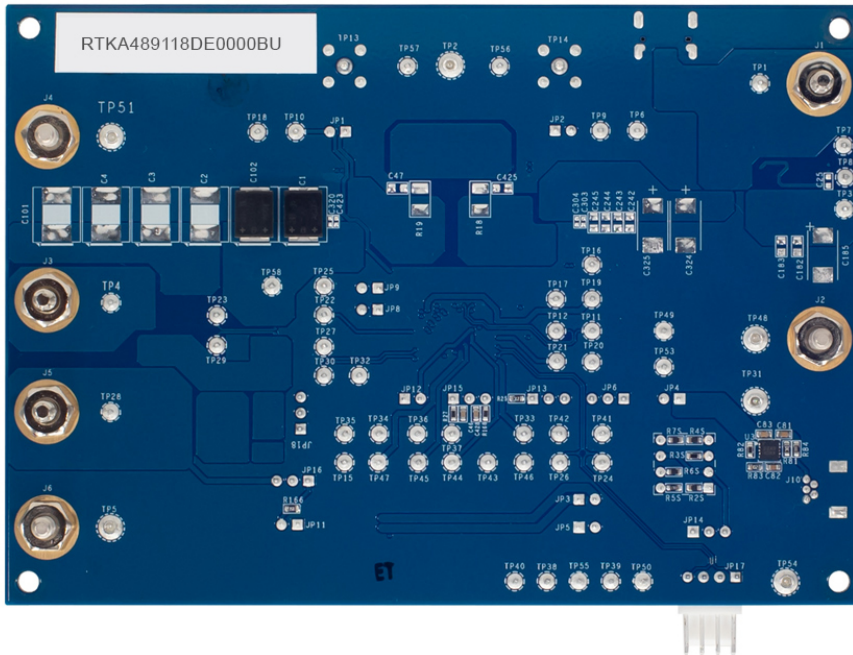

Figure 6. RTKA489118DE0000BU Evaluation Board (Bottom)

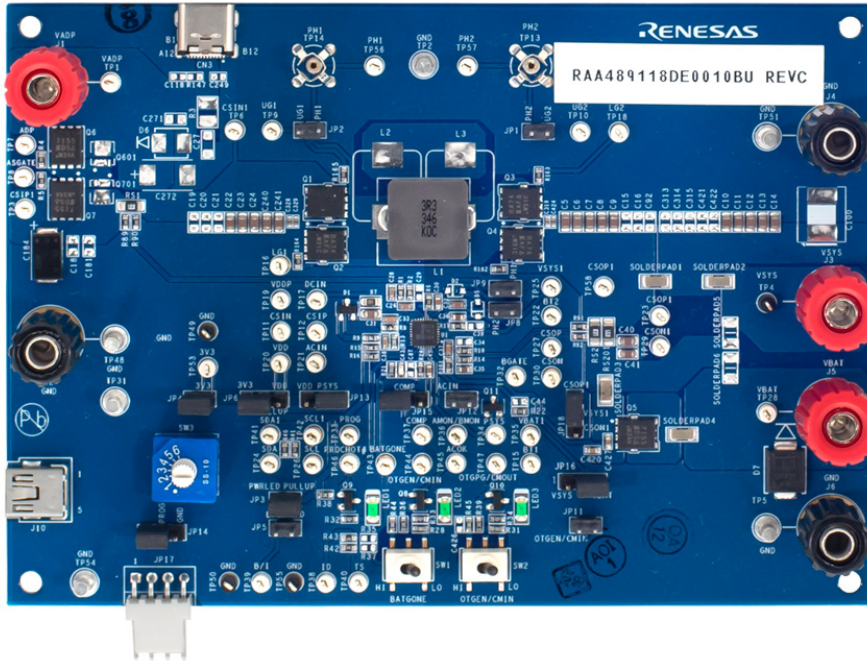

Figure 7. RTKA489118DE0010BU Evaluation Board (Top)

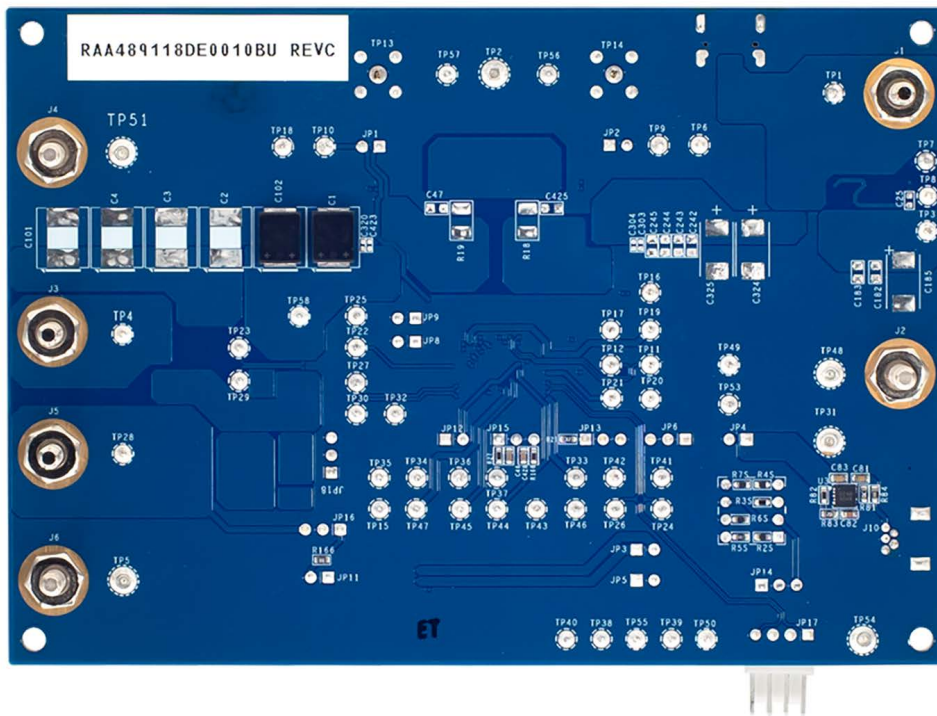
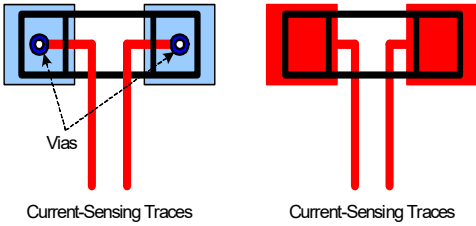
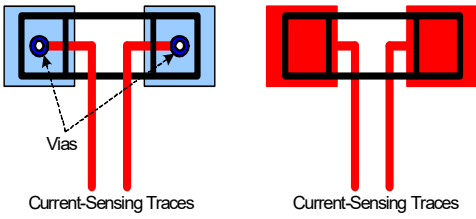

Figure 8. RTKA489118DE0010BU Evaluation Board (Bottom)

2.1 Layout Guidelines

Pin #	Pin Name	Layout Guidelines
Bottom Pad 33	GND	Connect the ground pad to the ground plane through a low impedance path. Use at least five vias to connect to the ground planes in the PCB to ensure sufficient thermal dissipation directly under the IC.
1	CSON	Run two dedicated traces with sufficient width parallel (close to each other to minimize the loop area) to the two terminals of the battery current-sensing resistor to the IC. Place the differential mode and common-mode RC filter components in the general proximity of the controller.
2	CSOP	<p>Route the current-sensing traces through vias to connect the center of the pads, or route the traces into the pads from the inside of the current-sensing resistor. The following drawings show the two preferred ways of routing current-sensing traces.</p> 
3	VSYS	Signal pin provides feedback for the system bus voltage. Place the optional RC filter in the general proximity of the controller. Run a dedicated trace from the system bus to the pin and do not route near the switching traces. Do not share the same trace with the signal routing to the DCIN pin or diodes and the CSOP trace.
4	BOOT2	Switching pin. Place the bootstrap capacitor in the general proximity of the controller. Use sufficiently wide traces. Do not allow any sensitive analog signal traces to cross over or get close to this pin.
5	UGATE2	Run the UGATE2 and PHASE2 traces in parallel with sufficient width. Do not allow any sensitive analog signal traces to cross over or get close to this pin. Renesas recommends routing the PHASE2 trace to the high-side MOSFET source pin instead of general copper.
6	PHASE2	<p>Place the IC close to the gate terminals of the switching MOSFETs and keep the gate drive signal traces short for a clean MOSFET drive. The IC can be placed on the opposite side of the switching MOSFETs.</p> <p>Place the output capacitors as close as possible to the switching high-side MOSFET drain and the low-side MOSFET source. Use the shortest PCB trace connection. Place the capacitors on the same PCB layer as the MOSFETs instead of on different layers and using vias to make the connection.</p> <p>Place the inductor terminal as close as possible to the switching high-side MOSFET drain and low-side MOSFET source terminal. Minimize this phase node area to lower the electrical and magnetic field radiation but make this phase node area large enough to carry the current. Place the inductor and the switching MOSFETs on the same PCB layer.</p>
7	LGATE2	Switching pin. Run the LGATE2 trace parallel to the UGATE2 and PHASE2 traces on the same PCB layer. Use sufficient width. Do not allow any sensitive analog signal traces to cross over or get close to this pin.
8	VDDP	Place the decoupling capacitor in the general proximity of the controller. Run the trace connecting to the VDD pin with sufficient width.
9	LGATE1	Switching pin. Run the LGATE1 trace parallel to the UGATE1 and PHASE1 traces on the same PCB layer. Use sufficient width. Do not allow any sensitive analog signal traces to cross over or get close to this pin.

Pin #	Pin Name	Layout Guidelines
10	PHASE1	Run the PHASE1 and UGATE1 traces in parallel with sufficient width. Do not allow any sensitive analog signal traces to cross over or get close to these pins. Renesas recommends routing the PHASE1 trace to the high-side MOSFET source pin instead of general copper.
11	UGATE1	Place the IC close to the switching MOSFET's gate terminals and keep the gate drive signal traces short for a clean MOSFET drive. The IC can be placed on the opposite side of the switching MOSFETs.
		Place the input capacitors as close as possible to the switching high-side MOSFET drain and the low-side MOSFET source. Use the shortest PCB trace connection. Place the input capacitors on the same PCB layer as the MOSFETs instead of on different layers and using vias to make the connection.
		Place the inductor terminal to the switching high-side MOSFET drain and low-side MOSFET source terminal as close as possible. Minimize the phase node area to lower the electrical and magnetic field radiation, but make this phase node area large enough to carry the current. Place the inductor and the switching MOSFETs on the same layer of the PCB.
12	BOOT1	Switching pin. Place the bootstrap capacitor in the general proximity of the controller. Use a sufficiently wide trace. Do not allow any sensitive analog signal traces to cross over or get close to this pin.
13	ASGATE	Run this trace with sufficient width parallel to the ADP pin trace.
14	CSIN	Run two dedicated traces with sufficient width parallel to (close to each other to minimize the loop area) the two terminals of the adapter current-sensing resistor to the IC. Place the differential mode and common-mode RC filter components in the general proximity of the controller.
15	CSIP	Route the current-sensing traces through vias to connect the center of the pads or route the traces into the pads from the inside of the current-sensing resistor. The following drawings show the two preferred ways of routing current-sensing traces.
		
16	ADP	Run this trace with sufficient width parallel to the ASGATE pin trace.
17	DCIN	Place the OR diodes and the RC filter in the general proximity of the controller. Run the VADP trace and VSYS trace to the OR diodes with sufficient width.
18	VDD	Place the RC filter connecting with the VDDP pin in general proximity of the controller. Run the trace connecting to VDDP pin with sufficient width.
19	ACIN	Place the voltage divider resistors and the optional decoupling capacitor in the general proximity of the controller.
20	CMIN	No special consideration.
21	SDA	Digital pins. No special consideration. Run the SDA and SCL traces in parallel.
22	SCL	
23	PROCHOT#	Digital pin, open-drain output. No special consideration.
24	ACOK	
25	BATGONE	Digital pin. Place the 100kΩ resistor series in the BATGONE signal trace and the optional decoupling capacitor in the general proximity of the controller.

Pin #	Pin Name	Layout Guidelines
26	OTGPG/ CMOUT	Digital pin, open-drain output. No special consideration.
27	PROG	Signal pin. Place the PROG programming resistor in the general proximity of the controller.
28	COMP	Place the compensation components in the general proximity of the controller. Do not allow any switching signals to cross over or get close to this pin.
29	AMON/BMON	No special consideration. Place the optional RC filter in the general proximity of the controller.
30	CONFIG/ PSYS	Dual-purpose pin: Configuration input or current source signal output. No special consideration.
31	VBAT	Place the optional RC filter in the general proximity of the controller. Run a dedicated trace from the battery positive connection point to the IC.
32	BGATE	Use a sufficiently wide trace from the IC to the BGATE MOSFET gate. Place the capacitor from BGATE to ground close to the MOSFET.

2.2 Schematic Diagrams

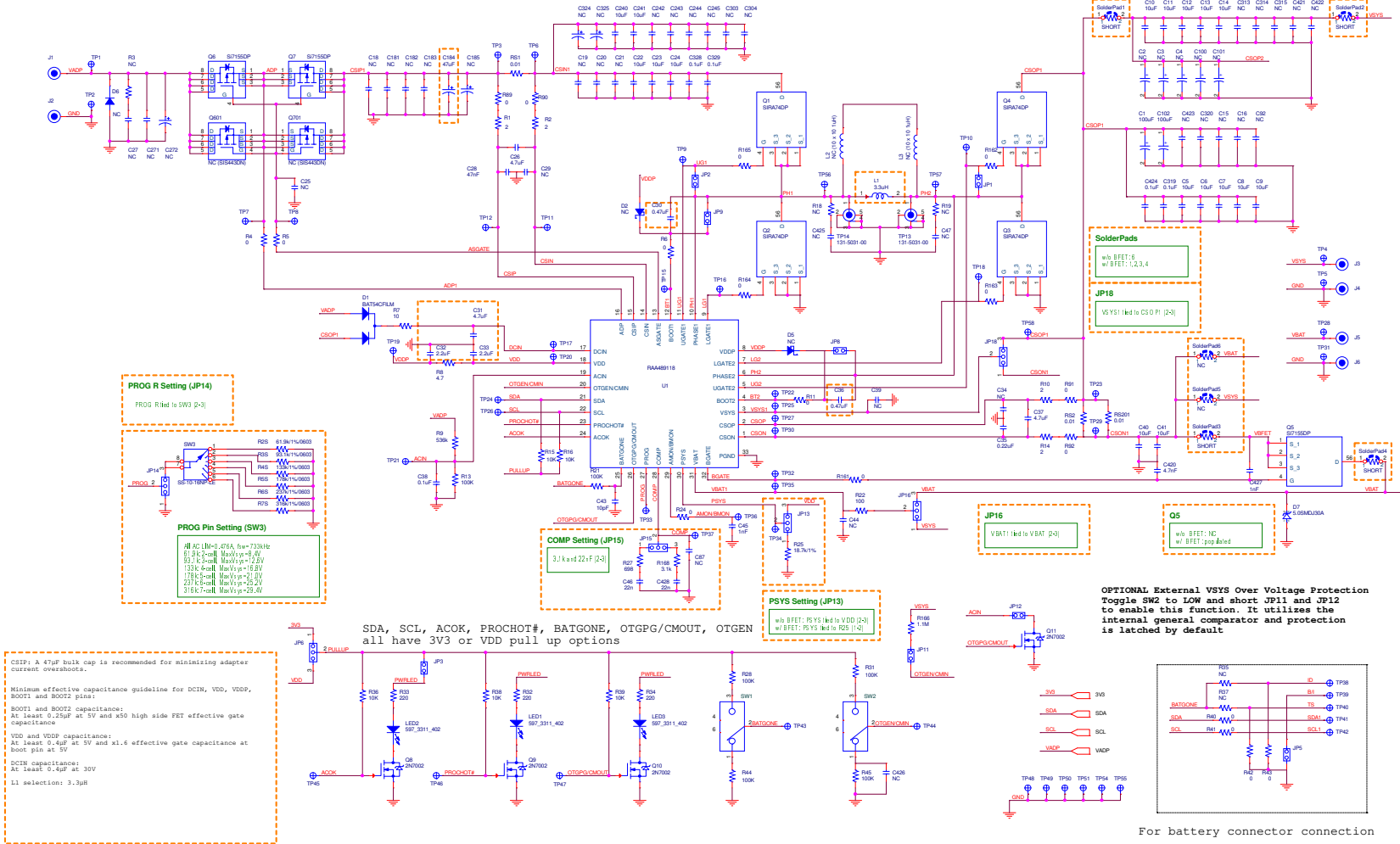

Figure 9. Schematic (1 of 2)

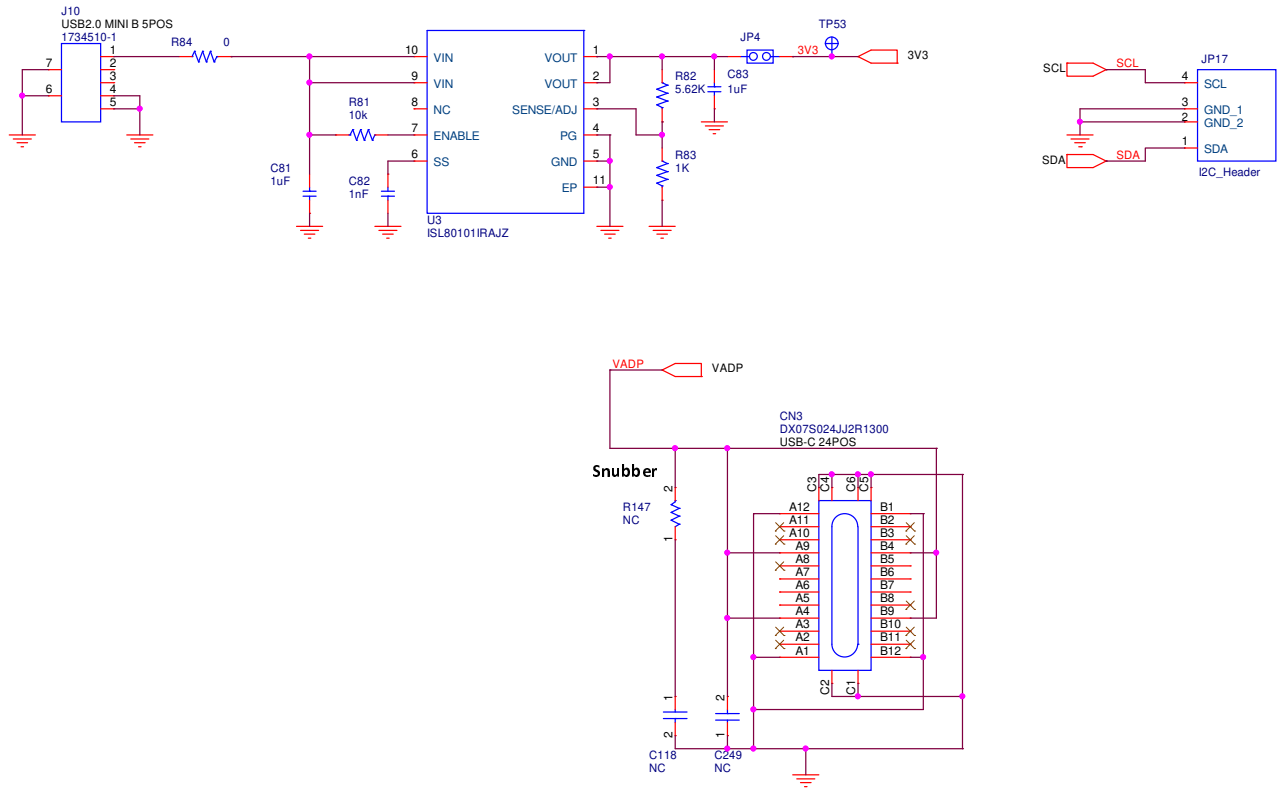

Figure 10. Schematic (2 of 2)

2.3 Bill of Materials

2.3.1 RTKA489118DE0000BU

Qty	Reference Designator	Description	Manufacturer	Manufacturer Part Number
1	CN3	CONN RCP USB3.1 TYPEC 24P SMD RA	JAE Electronics	DX07S024JJ2R1300
1	C184	CAP TANT POLY 47µF 35V 2917	Vishay Polytech	T52E5476M035C0070
2	C1, C102	CAP TANT POLY 100µF 35V 2924	Vishay Polytech	T52M1107M035C0055
17	C5, C6, C7, C8, C9, C10, C11, C12, C13, C14, C22, C23, C24, C40, C41, C240, C241	CAP CER 10µF 35V X5R 0805	Murata Electronics	GRM21BR6YA106KE43L
2	C26, C37	CAP CER 4.7µF 16V X5R 0603	Murata Electronics	GRM188R61C475KE11D
1	C28	CAP CER 0.047µF 50V X7R 0603	Murata Electronics	GRM155R71H473KE14D
2	C30, C36	CAP CER 0.47µF 50V X7R 0603	TDK Corporation	C1608X7R1H474K080AC
1	C35	CAP CER 0.22µF 50V X7R 0603	TDK Corporation	CGA3E3X7R1H224K080AB
1	C31	CAP CER 4.7µF 50V X7S 0805	Murata Electronics	GRM21BC71H475KE11K
2	C32, C33	CAP CER 2.2µF 50V X5R 0603	Murata Electronics	GRM188R61H225KE11D

Qty	Reference Designator	Description	Manufacturer	Manufacturer Part Number
4	C319, C328, C329, C424	CAP CER 0.1µF 50V X7R 0402	Murata Electronics	GRM155R71H104KE14J
1	C38	CAP CER 0.1µF 50V X7R 0603	Murata Electronics	GCM188R71H104KA57J
1	C43	CAP CER 10PF 50V X7R 0603	KYOCERA AVX	06035C100KAT2A
3	C45, C82, C427	CAP CER 1000PF 50V X7R 0603	TDK Corporation	CGA3E2X7R1H102K080AA
2	C46, C428	CAP CER 0.022µF 50V X7R 0603	Murata Electronics	GCJ188R71H223KA01D
2	C81, C83	CAP CER 1µF 50V X5R 0603	Murata Electronics	GRT188R61H105KE13D
1	C420	CAP CER 4700PF 100V X7R 0603	TDK Corporation	C1608X7R2A472K080AA
3	RS1, RS2, RS201	RES 0.01Ω 1% 1W 1206	Vishay Dale	WSLP1206R0100FEA
4	R1, R2, R10, R14	RES 2Ω 1% 1/10W 0603	YAGEO	RC0603FR-072RL
19	R4, R5, R6, R11, R24, R40, R41, R42, R43, R84, R89, R90, R91, R92, R161, R162, R163, R164, R165	RES 0Ω JUMPER 1/10W 06030	Vishay Dale	CRCW06030000Z0EAC
1	R7	RES SMD 10Ω 5% 0.4W 0805	Rohm Semiconductor	ESR10EZPJ100
1	R8	RES 4.7Ω 1% 1/10W 0603	YAGEO	RC0603FR-074R7L
1	R9	RES 536KΩ 1% 1/10W 0603	YAGEO	RC0603FR-07536KL
6	R13, R21, R28, R31, R44, R45	RES 100KΩ 1% 1/10W 0603	YAGEO	RC0603FR-07100KL
6	R15, R16, R36, R38, R39, R81	RES 10KΩ 1% 1/10W 0603	YAGEO	RC0603FR-0710KL
2	R22, R167	RES SMD 100Ω 1% 1/10W 0603	TE Connectivity Passive Product	CRG0603F100R
1	R2S	RES SMD 61.9KΩ 1% 1/10W 0603	Vishay Dale	CRCW060361K9FKEA
1	R3S	RES SMD 93.1KΩ 1% 1/10W 0603	Vishay Dale	CRCW060393K1FKEA
1	R4S	RES SMD 133KΩ 1% 1/10W 0603	Vishay Dale	CRCW0603133KFKEA
1	R5S	RES 178KΩ 1% 1/10W 0603	Vishay Dale	CRCW0603178KFKEAC
1	R6S	RES SMD 237KΩ 1% 1/10W 0603	Vishay Dale	CRCW0603237KFKEA
1	R7S	RES SMD 316KΩ 1% 1/10W 0603	Vishay Dale	CRCW0603316KFKEB
1	R25	RES 18.7KΩ 1% 1/10W 0603	YAGEO	RC0603FR-0718K7L
3	R32, R33, R34	RES 220Ω 1% 1/10W 0603	YAGEO	RC0603FR-07220RL
1	R27	RES SMD 698Ω 1% 1/10W 0603	Panasonic Electronic Components	ERJ-3EKF6980V
1	R168	RES SMD 3.09KΩ 1% 1/10W 0603	Panasonic Electronic Components	ERJ-3EKF3091V

Qty	Reference Designator	Description	Manufacturer	Manufacturer Part Number
1	R82	RES SMD 5.62KΩ 1% 1/10W 0603	Panasonic Electronic Components	ERJ-3EKF5621V
1	R83	RES 1KΩ 5% 1/10W 0603	YAGEO	RC0603JR-071KL
1	R166	RES 1.1MΩ 1% 1/10W 0603	YAGEO	RC0603FR-071M1L
2	SW1, SW2	SWITCH TOGGLE SPDT 0.4VA 20V	C&K	GT11MSCBE
1	SW3	SWITCH ROTARY DIP SP6T 100MA 5V	Nidec Components Corporation	SS-10-16NP-LE
46	TP1, TP3, TP4, TP6, TP7, TP8, TP9, TP10, TP11, TP12, TP15, TP16, TP17, TP18, TP19, TP20, TP21, TP22, TP23, TP24, TP25, TP26, TP27, TP28, TP29, TP30, TP32, TP33, TP34, TP35, TP36, TP37, TP38, TP39, TP40, TP41, TP42, TP43, TP44, TP45, TP46, TP47, TP53, TP56, TP57, TP58	PC TEST POINT MINIATURE WHITE	Keystone Electronics	5002
3	TP49, TP50, TP55	PC TEST POINT MINIATURE BLACK	Keystone Electronics	5001
6	TP2, TP5, TP31, TP48, TP51, TP54	TERM TURRET SINGLE L = 7.65MM TIN	Keystone Electronics	1598-2
2	TP13, TP14	Test Connectors	Tektronix	131-5031-00
1	D1	DIODE ARRAY SCHOTTKY 40V SOT23-3	STMicroelectronics	BAT54CFILM
1	D7	TVS DIODE 33VWM 53.3VC DO214AB	Littelfuse Inc.	5.0SMDJ33A
9	JP1, JP2, JP3, JP4, JP5, JP8, JP9, JP11, JP12	CONN HEADER VERT 2POS	TE Connectivity AMP Connectors	9-146258-0-01
6	JP6 (1-2) JP13 (2-3) JP14 (2-3) JP15 (2-3) JP16 (2-3) JP18 (2-3)	CONN HEADER VERT 3POS	Würth Elektronik	61300311121
1	JP17	CONN HEADER R/A 4POS 2.54MM	Molex	22053041

Qty	Reference Designator	Description	Manufacturer	Manufacturer Part Number
3	J1, J3, J5	CONN BIND POST KNURLED RED	Cinch Connectivity Solutions Johnson	111-0702-001
3	J2, J4, J6	CONN BIND POST KNURLED BLACK	Cinch Connectivity Solutions Johnson	111-0703-001
1	J10	CONN RCPT USB2.0 MINI B 5POS R/A	TE Connectivity AMP Connectors	1734510-1
3	LED1, LED2, LED3	LED GREEN DIFFUSED 1206 SMD	Visual Communications Company - VCC	CMD15-21VGD/TR8
4	Q1, Q2, Q3, Q4	MOSFET N-CH 40V 24A/81.2A PPAK	Vishay Siliconix	SIRA74DP
2	Q6, Q7	MOSFET -40V Vds 20V Vgs PowerPAK SO-8	Vishay Siliconix	SI7155DP-T1-GE3
4	Q8, Q9, Q10, Q11	MOSFET N-CH 60V 300MA TO236	Vishay Siliconix	2N7002K-T1-GE3
1	U3	IC REG LINEAR POS ADJ 1A 10DFN	Renesas Electronics Corporation	ISL80101IRAJZ
1	U1	RAA489118	Renesas Electronics Corporation	RAA489118
1	SolderPad6	RES 0Ω JUMPER 1206	KOA Speer Electronics, Inc.	TLRZ2BTDD
1	L1	3.3μH Inductor	Delta Electronics/Cyntec	CMLS133E-3R3MS-87
4	-	HEX STANDOFF #4-40 ALUMINUM 3/4"	Keystone Electronics	Standoff
4	-	MACHINE SCREW PAN PHILLIPS 4-40	B&F Fastener Supply	SCREW
8	-	CONN JUMPER SHORTING GOLD FLASH	Sullins Connector Solutions	JUMPER SHORTING

2.3.2 RTKA489118DE0010BU

Qty	Reference Designator	Description	Manufacturer	Manufacturer Part Number
1	CN3	CONN RCP USB3.1 TYPEC 24P SMD RA	JAE Electronics	DX07S024JJ2R1300
1	C184	CAP TANT POLY 47μF 35V 2917	Vishay Polytech	T52E5476M035C0070
2	C1, C102	CAP TANT POLY 100μF 35V 2924	Vishay Polytech	T52M1107M035C0055
17	C5, C6, C7, C8, C9, C10, C11, C12, C13, C14, C22, C23, C24, C40, C41, C240, C241	CAP CER 10μF 35V X5R 0805	Murata Electronics	GRM21BR6YA106KE43L
2	C26, C37	CAP CER 4.7μF 16V X5R 0603	Murata Electronics	GRM188R61C475KE11D
1	C28	CAP CER 0.047μF 50V X7R 0603	Murata Electronics	GRM155R71H473KE14D
2	C30, C36	CAP CER 0.47μF 50V X7R 0603	TDK Corporation	C1608X7R1H474K080AC
1	C35	CAP CER 0.22μF 50V X7R 0603	TDK Corporation	CGA3E3X7R1H224K080AB

Qty	Reference Designator	Description	Manufacturer	Manufacturer Part Number
1	C31	CAP CER 4.7 μ F 50V X7S 0805	Murata Electronics	GRM21BC71H475KE11K
2	C32, C33	CAP CER 2.2 μ F 50V X5R 0603	Murata Electronics	GRM188R61H225KE11D
4	C319, C328, C329, C424	CAP CER 0.1 μ F 50V X7R 0402	Murata Electronics	GRM155R71H104KE14J
1	C38	CAP CER 0.1 μ F 50V X7R 0603	Murata Electronics	GCM188R71H104KA57J
1	C43	CAP CER 10PF 50V X7R 0603	KYOCERA AVX	06035C100KAT2A
3	C45, C82, C427	CAP CER 1000PF 50V X7R 0603	TDK Corporation	CGA3E2X7R1H102K080AA
2	C46, C428	CAP CER 0.022 μ F 50V X7R 0603	Murata Electronics	GCJ188R71H223KA01D
2	C81, C83	CAP CER 1 μ F 50V X5R 0603	Murata Electronics	GRT188R61H105KE13D
1	C420	CAP CER 4700PF 100V X7R 0603	TDK Corporation	C1608X7R2A472K080AA
3	RS1, RS2, RS201	RES 0.01 Ω 1% 1W 1206	Vishay Dale	WSLP1206R0100FEA
4	R1, R2, R10, R14	RES 2 Ω 1% 1/10W 0603	YAGEO	RC0603FR-072RL
19	R4, R5, R6, R11, R24, R40, R41, R42, R43, R84, R89, R90, R91, R92, R161, R162, R163, R164, R165	RES 0 Ω JUMPER 1/10W 06030	Vishay Dale	CRCW06030000Z0EAC
1	R7	RES SMD 10 Ω 5% 0.4W 0805	Rohm Semiconductor	ESR10EZPJ100
1	R8	RES 4.7 Ω 1% 1/10W 0603	YAGEO	RC0603FR-074R7L
1	R9	RES 536K Ω 1% 1/10W 0603	YAGEO	RC0603FR-07536KL
6	R13, R21, R28, R31, R44, R45	RES 100K Ω 1% 1/10W 0603	YAGEO	RC0603FR-07100KL
6	R15, R16, R36, R38, R39, R81	RES 10K Ω 1% 1/10W 0603	YAGEO	RC0603FR-0710KL
2	R22, R167	RES SMD 100 Ω 1% 1/10W 0603	TE Connectivity Passive Product	CRG0603F100R
1	R2S	RES SMD 61.9K Ω 1% 1/10W 0603	Vishay Dale	CRCW060361K9FKEA
1	R3S	RES SMD 93.1K Ω 1% 1/10W 0603	Vishay Dale	CRCW060393K1FKEA
1	R4S	RES SMD 133K Ω 1% 1/10W 0603	Vishay Dale	CRCW0603133KFKEA
1	R5S	RES 178K Ω 1% 1/10W 0603	Vishay Dale	CRCW0603178KFKEAC
1	R6S	RES SMD 237K Ω 1% 1/10W 0603	Vishay Dale	CRCW0603237KFKEA
1	R7S	RES SMD 316K Ω 1% 1/10W 0603	Vishay Dale	CRCW0603316KFKEB
1	R25	RES 18.7K Ω 1% 1/10W 0603	YAGEO	RC0603FR-0718K7L
3	R32, R33, R34	RES 220 Ω 1% 1/10W 0603	YAGEO	RC0603FR-07220RL
1	R27	RES SMD 698 Ω 1% 1/10W 0603	Panasonic Electronic Components	ERJ-3EKF6980V

Qty	Reference Designator	Description	Manufacturer	Manufacturer Part Number
1	R168	RES SMD 3.09K Ω 1% 1/10W 0603	Panasonic Electronic Components	ERJ-3EKF3091V
1	R82	RES SMD 5.62K Ω 1% 1/10W 0603	Panasonic Electronic Components	ERJ-3EKF5621V
1	R83	RES 1K Ω 5% 1/10W 0603	YAGEO	RC0603JR-071KL
1	R166	RES 1.1M Ω 1% 1/10W 0603	YAGEO	RC0603FR-071M1L
2	SW1, SW2	SWITCH TOGGLE SPDT 0.4VA 20V	C&K	GT11MSCBE
1	SW3	SWITCH ROTARY DIP SP6T 100MA 5V	Nidec Components Corporation	SS-10-16NP-LE
46	TP1, TP3, TP4, TP6, TP7, TP8, TP9, TP10, TP11, TP12, TP15, TP16, TP17, TP18, TP19, TP20, TP21, TP22, TP23, TP24, TP25, TP26, TP27, TP28, TP29, TP30, TP32, TP33, TP34, TP35, TP36, TP37, TP38, TP39, TP40, TP41, TP42, TP43, TP44, TP45, TP46, TP47, TP53, TP56, TP57, TP58	PC TEST POINT MINIATURE WHITE	Keystone Electronics	5002
3	TP49, TP50, TP55	PC TEST POINT MINIATURE BLACK	Keystone Electronics	5001
6	TP2, TP5, TP31, TP48, TP51, TP54	TERM TURRET SINGLE L=7.65MM TIN	Keystone Electronics	1598-2
2	TP13, TP14	Test Connectors	Tektronix	131-5031-00
1	D1	DIODE ARRAY SCHOTTKY 40V SOT23-3	STMicroelectronics	BAT54CFILM
1	D7	TVS DIODE 33VWM 53.3VC DO214AB	Littelfuse Inc.	5.0SMDJ33A
9	JP1, JP2, JP3, JP4, JP5, JP8, JP9, JP11, JP12	CONN HEADER VERT 2POS	TE Connectivity AMP Connectors	9-146258-0-01
6	JP6 (1-2) JP13 (1-2) JP14 (2-3) JP15 (2-3) JP16 (2-3) JP18 (2-3)	CONN HEADER VERT 3POS	Würth Elektronik	61300311121

Qty	Reference Designator	Description	Manufacturer	Manufacturer Part Number
1	JP17	CONN HEADER R/A 4POS 2.54MM	Molex	22053041
3	J1, J3, J5	CONN BIND POST KNURLED RED	Cinch Connectivity Solutions Johnson	111-0702-001
3	J2, J4, J6	CONN BIND POST KNURLED BLACK	Cinch Connectivity Solutions Johnson	111-0703-001
1	J10	CONN RCPT USB2.0 MINI B 5POS R/A	TE Connectivity AMP Connectors	1734510-1
3	LED1, LED2, LED3	LED GREEN DIFFUSED 1206 SMD	Visual Communications Company - VCC	CMD15-21VGD/TR8
4	Q1, Q2, Q3, Q4	MOSFET N-CH 40V 24A/81.2A PPAK	Vishay Siliconix	SIRA74DP
3	Q5, Q6, Q7	MOSFET -40V Vds 20V Vgs PowerPAK SO-8	Vishay Siliconix	SI7155DP-T1-GE3
4	Q8, Q9, Q10, Q11	MOSFET N-CH 60V 300MA TO236	Vishay Siliconix	2N7002K-T1-GE3
1	U3	IC REG LINEAR POS ADJ 1A 10DFN	Renesas Electronics Corporation	ISL80101IRAJZ
1	U1	RAA489118	Renesas Electronics Corporation	RAA489118
4	SolderPad1, SolderPad2, SolderPad3, SolderPad4	RES 0Ω JUMPER 1206	KOA Speer Electronics, Inc.	TLRZ2BTDD
1	L1	3.3μH Inductor	Delta Electronics/Cyntec	CMLS133E-3R3MS-87
4	-	HEX STANDOFF #4-40 ALUMINUM 3/4"	Keystone Electronics	Standoff
4	-	MACHINE SCREW PAN PHILLIPS 4-40	B&F Fastener Supply	SCREW
8	-	CONN JUMPER SHORTING GOLD FLASH	Sullins Connector Solutions	JUMPER SHORTING

2.4 Board Layout

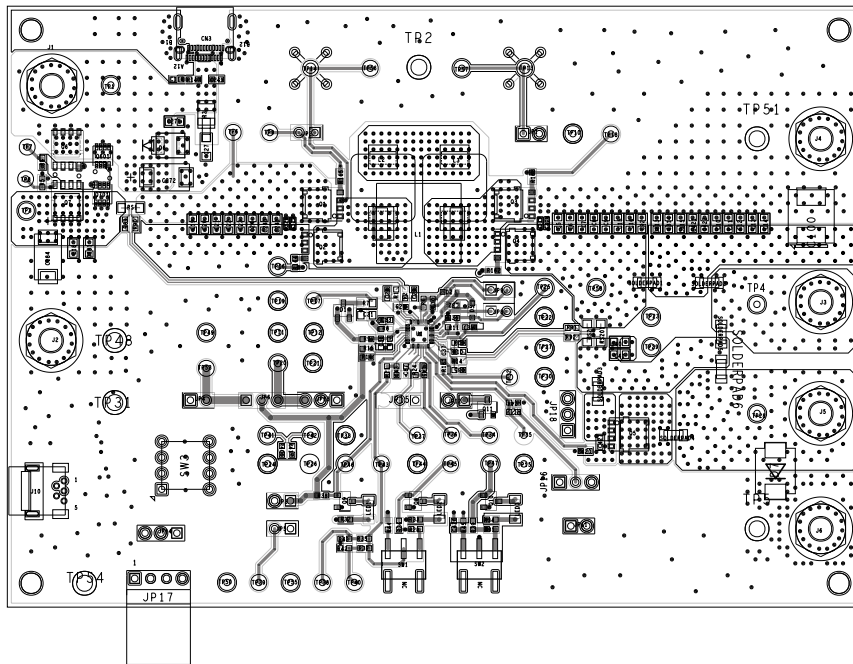

Figure 11. Top Layer

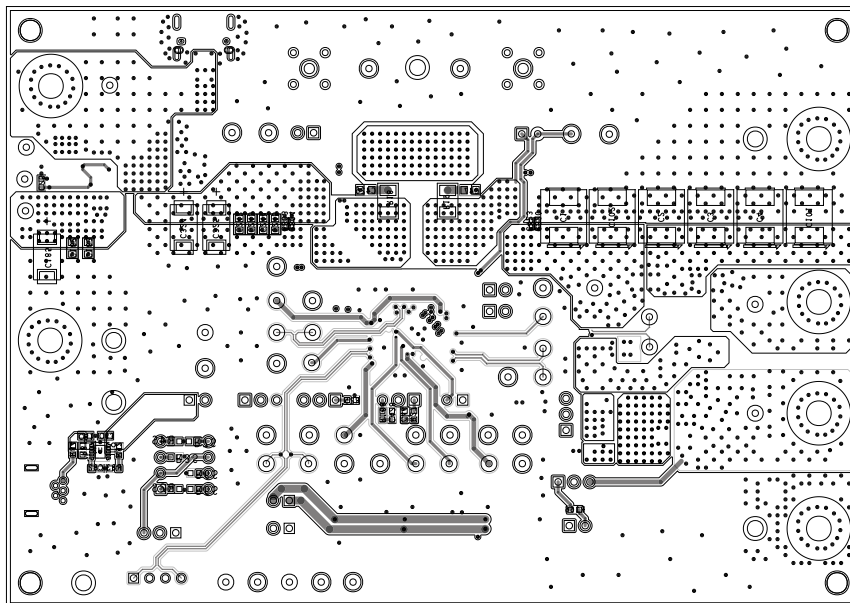

Figure 12. Bottom Layer

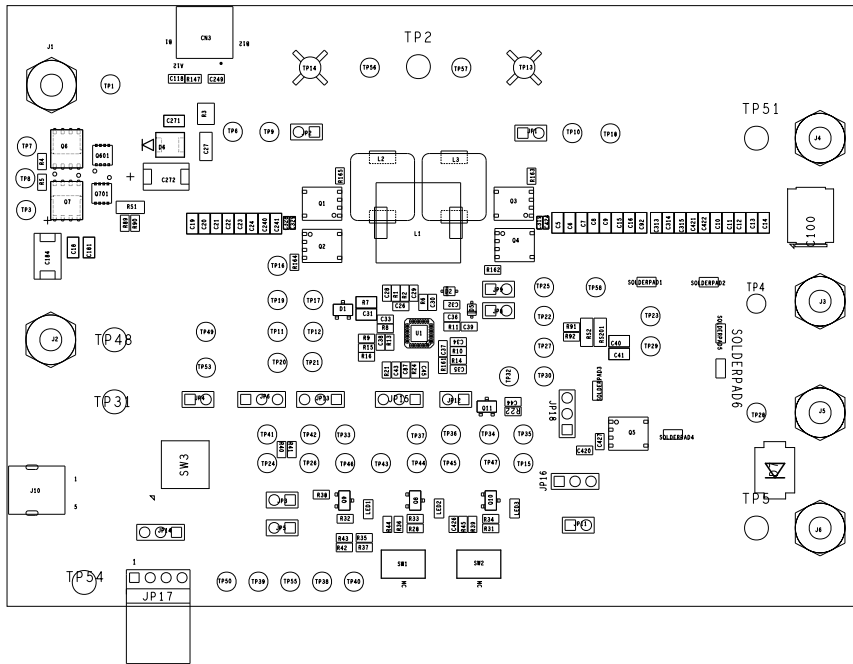

Figure 13. Top Silkscreen

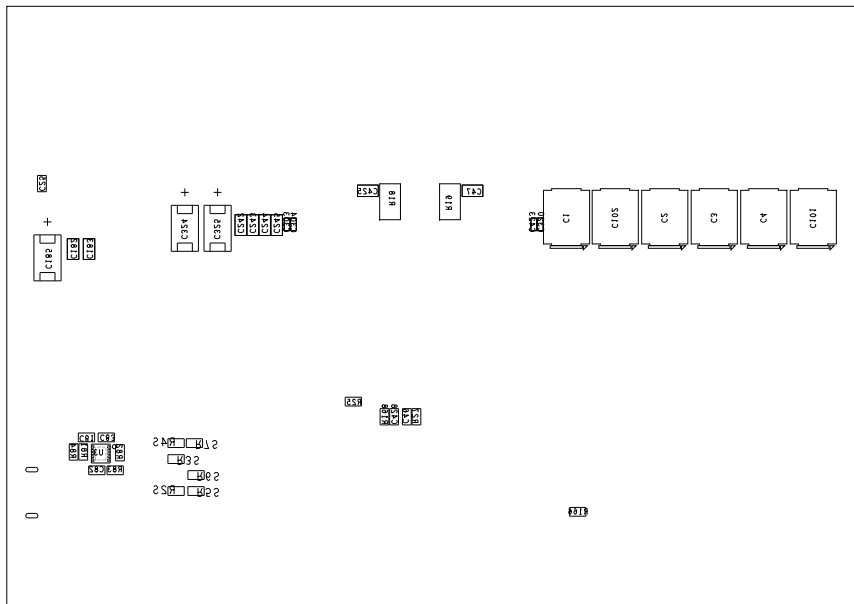

Figure 14. Bottom Silkscreen

3. Typical Performance Graphs

3.1 Battery Charging Only (No BFET)

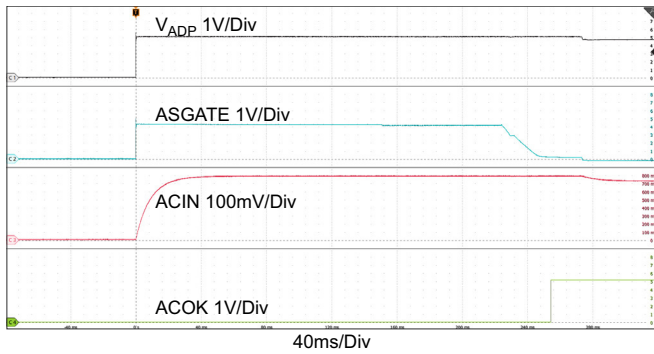

Figure 15. Adapter Insertion, V_{ADP} : 0V → 5V, V_{BAT} = 18V, ChargeCurrent = 0.256A

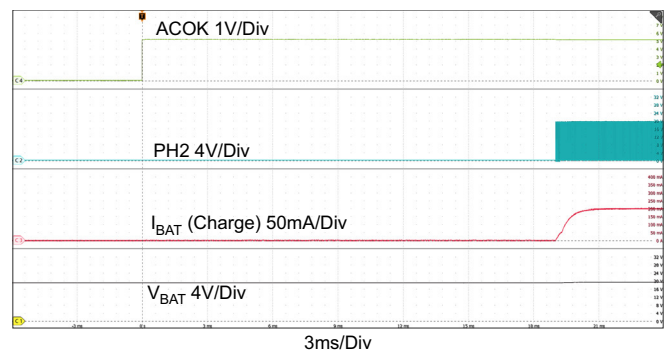

Figure 16. Adapter Insertion, V_{ADP} : 0V → 5V, V_{BAT} = 18V, ChargeCurrent = 0.256A (Figure 15 Zoomed In)

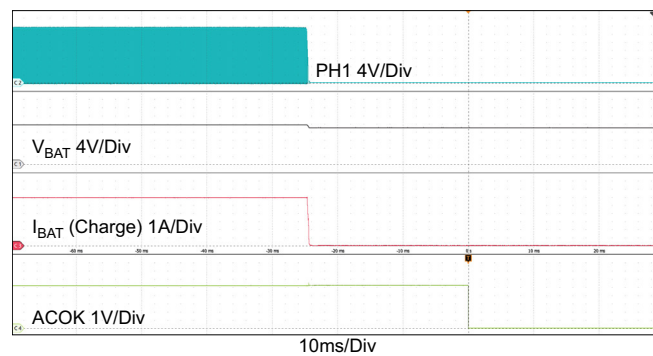

Figure 17. Adapter Removal, V_{ADP} : 28V → 0V, V_{BAT} = 18V, ChargeCurrent = 6A

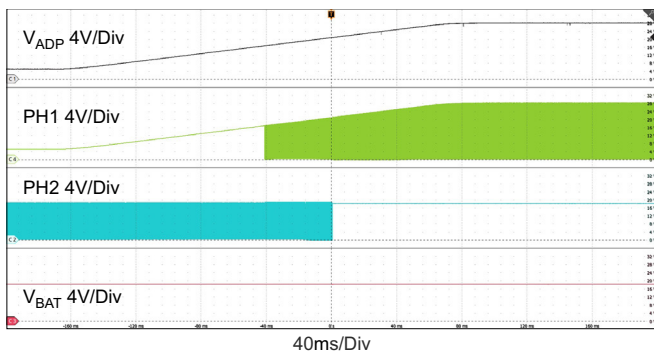

Figure 18. Adapter Voltage Ramp Up, Boost → Buck-Boost → Buck Operation Mode Transitions

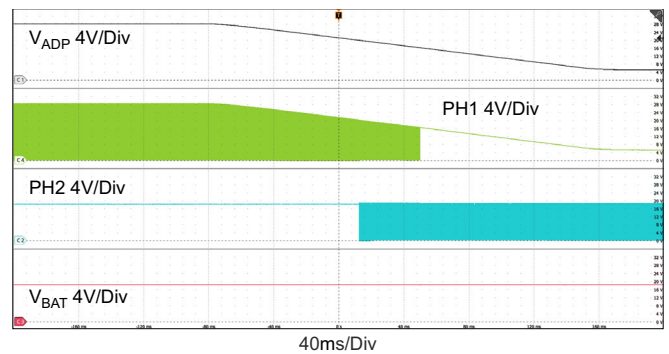

Figure 19. Adapter Voltage Ramp Down, Buck → Buck-Boost → Boost Operation Mode Transitions

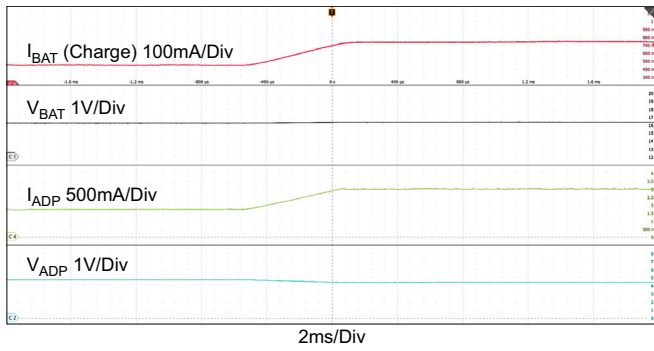

Figure 20. Boost Mode: Charge Current Loop to Adapter Current Loop, $V_{ADP} = 5V$, $V_{BAT} = 16V$, AdapterCurrentLimit = 3A, ChargeCurrent: 0.5A → 1A

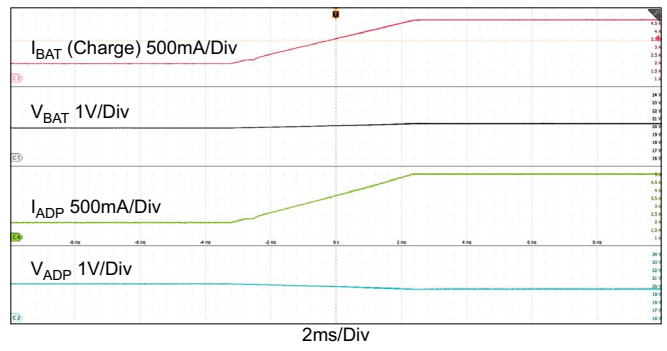

Figure 21. Buck_Boost Mode: Charge Current Loop to Adapter Current Loop, $V_{ADP} = 20V$, $V_{BAT} = 19V$, AdapterCurrentLimit = 5A, ChargeCurrent: 2A → 6A Buck_Boost_CCM_stretch_period = 2x

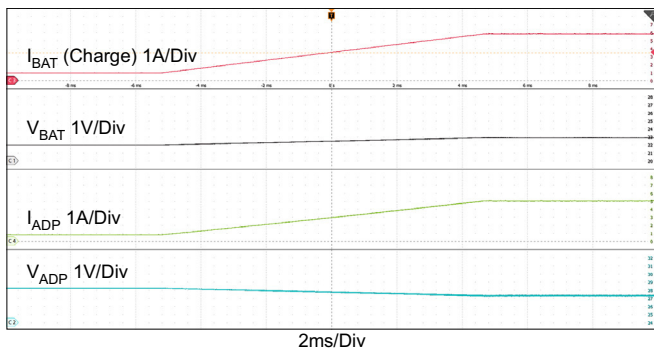

Figure 22. Buck Mode: Charge Current Loop to Adapter Current Loop, $V_{ADP} = 28V$, $V_{BAT} = 22V$, AdapterCurrentLimit = 5A, ChargeCurrent: 1A → 7A

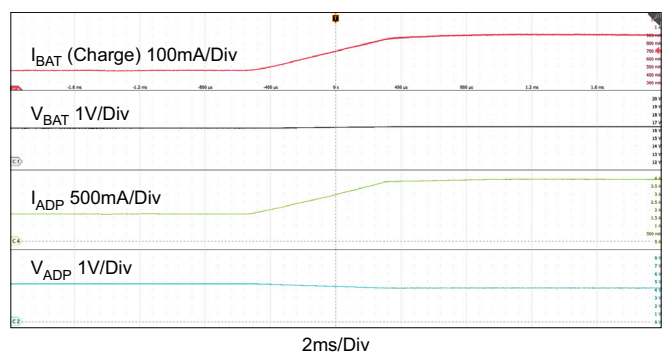

Figure 23. Boost Mode: Charge Current Loop to Input Voltage Loop, $V_{ADP} = 5V$, $V_{BAT} = 16V$, ChargeCurrent: 0.5A → 2A, InputVoltageLimit = 4.096V

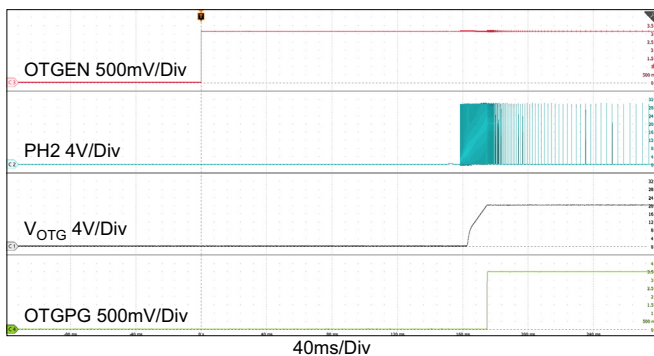

Figure 24. OTG Mode Enable, OTG_Debounce = 150ms, $V_{BAT} = 29.4V$, $V_{OTG} = 20V$

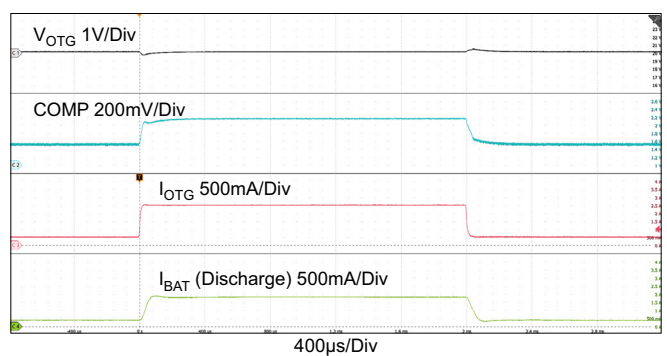

Figure 25. OTG Mode Transients, $V_{BAT} = 29.4V$, $V_{OTG} = 20V$, OTG Load: 0.5A ↔ 3A

3.2 NVDC Charging (with BFET)

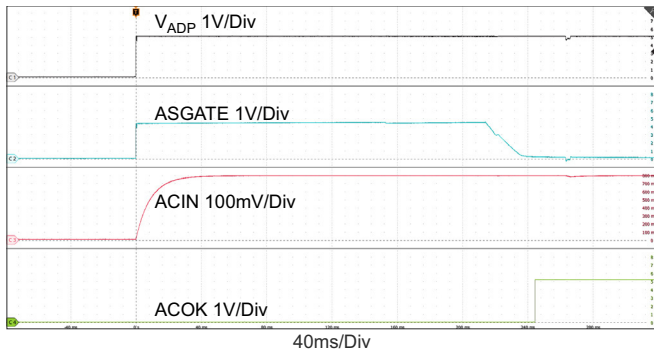

Figure 26. Adapter Insertion, V_{ADP}: 0V → 5V, V_{BAT} = 18V, ChargeCurrent = 0A

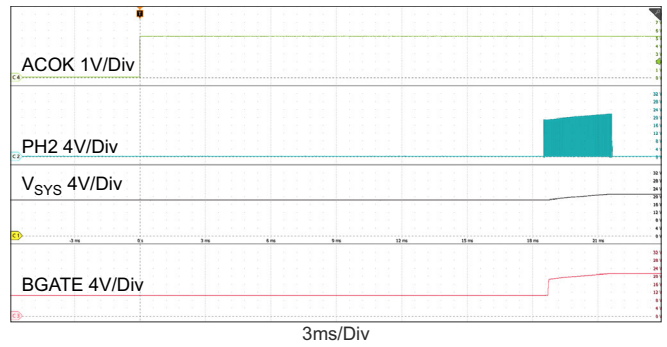

Figure 27. Adapter Insertion, V_{ADP}: 0V → 5V, V_{BAT} = 18V, ChargeCurrent = 0A (Figure 26 Zoomed In)

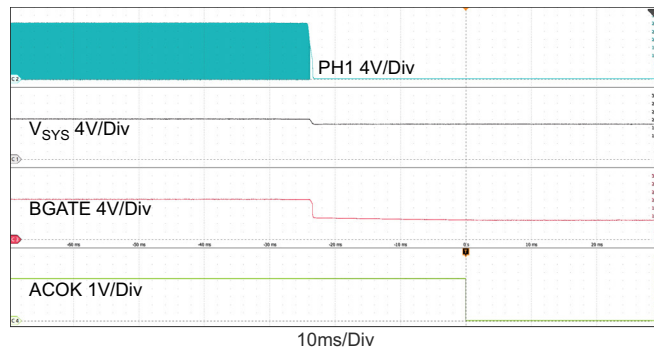

Figure 28. Adapter Removal, V_{ADP}: 28V → 0V, V_{BAT} = 18V, SystemLoad = 2A

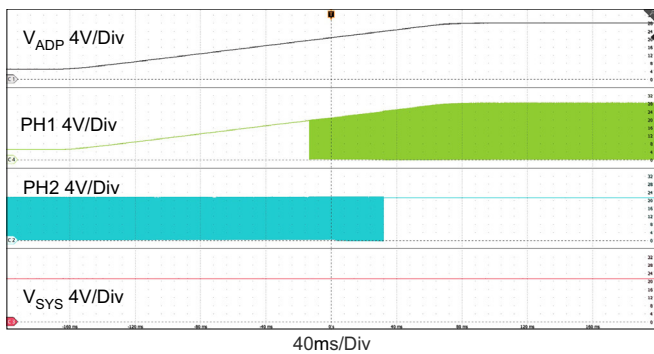

Figure 29. Adapter Voltage Ramp Up, Boost → Buck-Boost → Buck Operation Mode Transitions

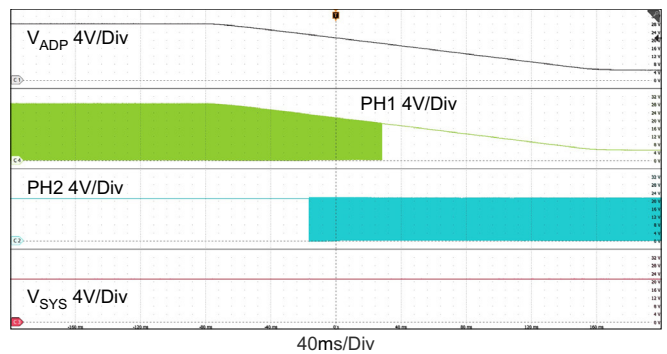

Figure 30. Adapter Voltage Ramp Down, Buck → Buck-Boost → Boost Operation Mode Transitions

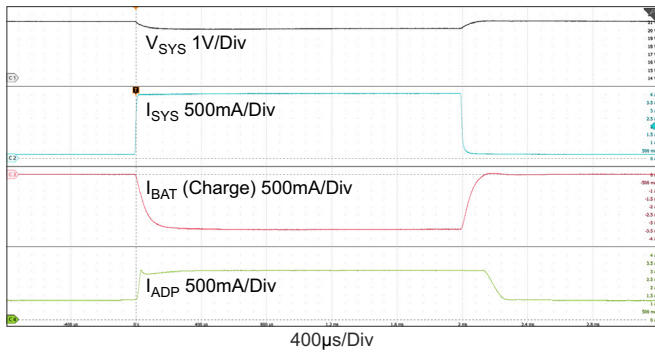

Figure 31. Boost Mode: Output Voltage Loop ↔ Adapter Current Loop, $V_{ADP} = 5V$, $MaxSystemVoltage = 21V$, $V_{BAT} = 20.5V$, $AdapterCurrentLimit = 3A$, $ChargeCurrent = 0A$, $SystemLoad: 0.2A \leftrightarrow 4A$

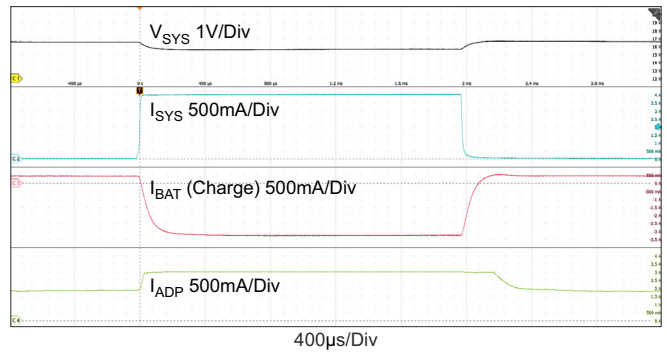

Figure 32. Boost Mode: Charge Current Loop ↔ Adapter Current Loop, $V_{ADP} = 5V$, $MaxSystemVoltage = 21V$, $V_{BAT} = 16V$, $AdapterCurrentLimit = 3A$, $ChargeCurrent = 0.5A$, $SystemLoad: 0A \leftrightarrow 4A$

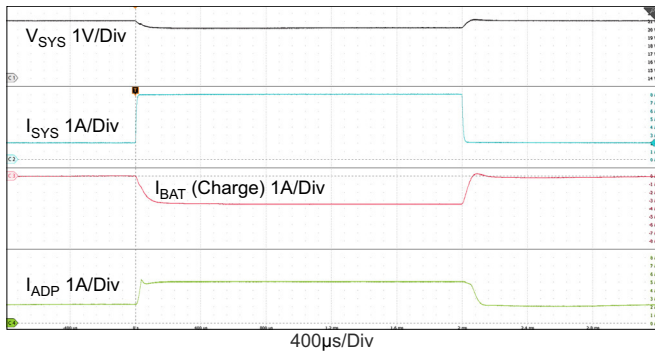

Figure 33. Buck-Boost Mode: Output Voltage Loop ↔ Adapter Current Loop, $V_{ADP} = 20V$, $MaxSystemVoltage = 21V$, $V_{BAT} = 20.5V$, $AdapterCurrentLimit = 5A$, $ChargeCurrent = 0A$, $SystemLoad: 2A \leftrightarrow 8A$, $Buck_Boost_CCM_stretch_period = 2x$

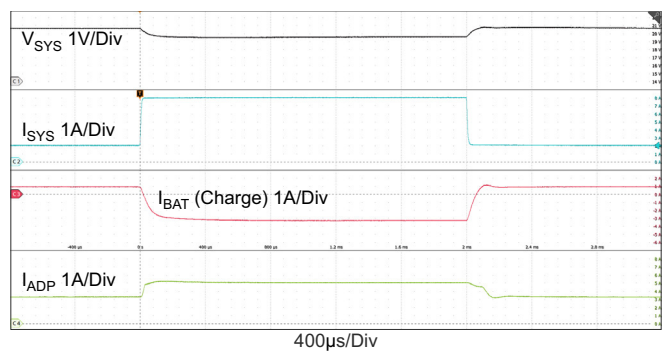

Figure 34. Buck-Boost Mode: Charge Current Loop ↔ Adapter Current Loop, $V_{ADP} = 20V$, $MaxSystemVoltage = 21V$, $V_{BAT} = 20V$, $AdapterCurrentLimit = 5A$, $ChargeCurrent = 1A$, $SystemLoad: 2A \leftrightarrow 8A$, $Buck_Boost_CCM_stretch_period = 2x$

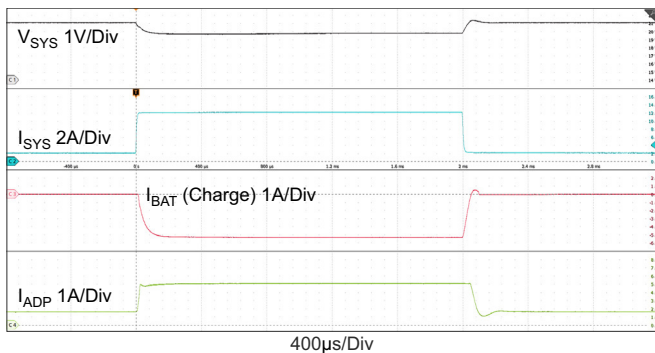

Figure 35. Buck Mode: Output Voltage Loop ↔ Adapter Current Loop, $V_{ADP} = 28V$, $MaxSystemVoltage = 21V$, $V_{BAT} = 20.5V$, $AdapterCurrentLimit = 5A$, $ChargeCurrent = 0A$, $SystemLoad: 2A \leftrightarrow 12A$

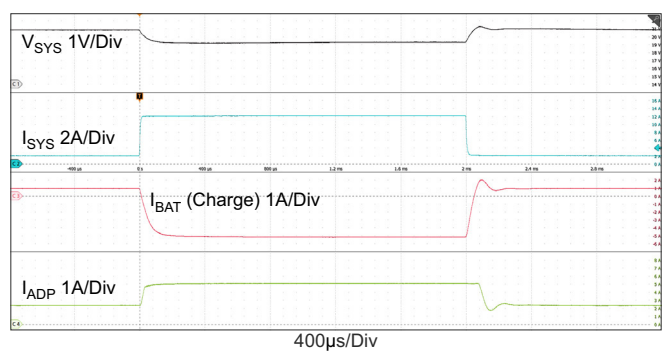

Figure 36. Buck Mode: Charge Current Loop ↔ Adapter Current Loop, $V_{ADP} = 28V$, $MaxSystemVoltage = 21V$, $V_{BAT} = 20V$, $AdapterCurrentLimit = 5A$, $ChargeCurrent = 1A$, $SystemLoad: 2A \leftrightarrow 12A$

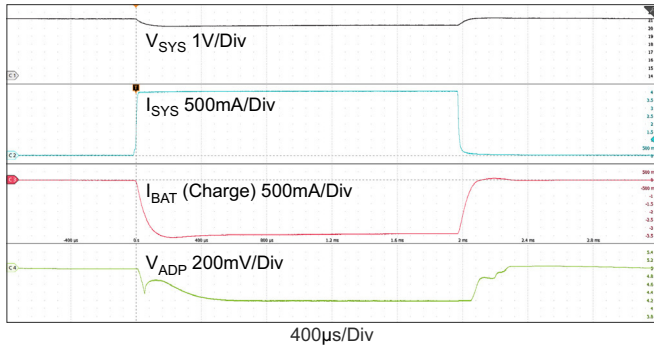

Figure 37. Boost Mode: Output Voltage Loop ↔ Input Voltage Loop, $V_{ADP} = 5V$, $MaxSystemVoltage = 21V$, $V_{BAT} = 20.5V$, $InputVoltageLimit = 4.096V$, $ChargeCurrent = 0A$, $SystemLoad: 0A \leftrightarrow 4A$

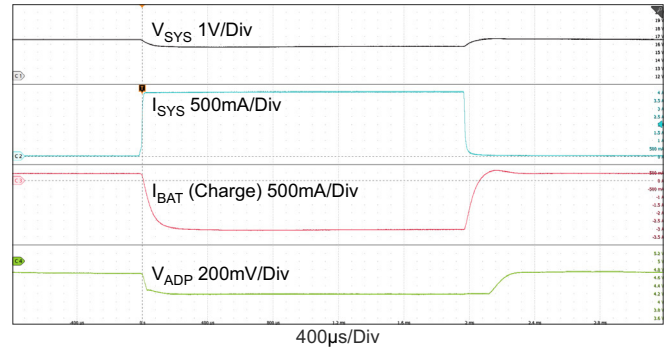

Figure 38. Boost Mode: Charge Current Loop ↔ Input Voltage Loop, $V_{ADP} = 5V$, $MaxSysVoltage = 21V$, $V_{BAT} = 16V$, $InputVoltageLimit = 4.096V$, $ChargeCurrent = 0.5A$, $SystemLoad: 0A \leftrightarrow 4A$

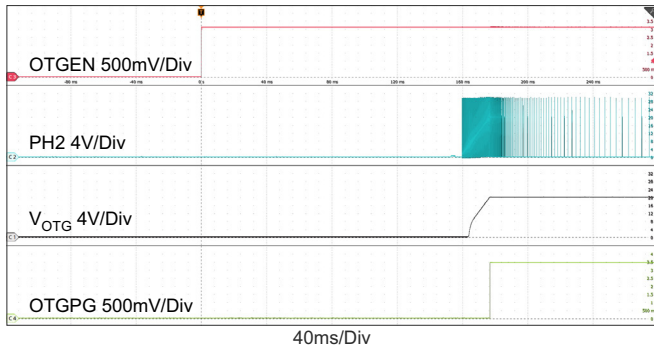

Figure 39. OTG Mode Enable. $OTG_Debounce = 150ms$, $V_{BAT} = 29.4V$, $V_{OTG} = 20V$

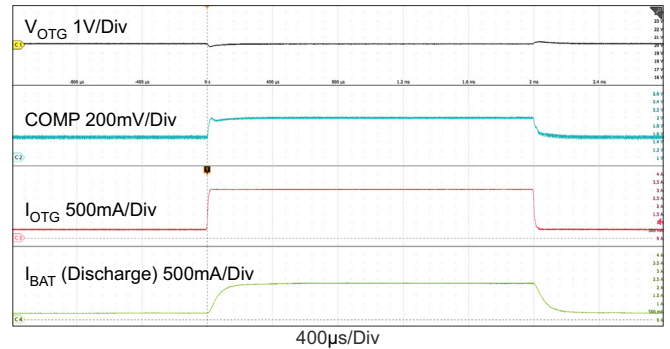

Figure 40. OTG Mode Transients. $V_{BAT} = 29.4V$, $V_{OTG} = 20V$, $OTG\ Current = 5A$, $OTG\ Load: 0.5A \leftrightarrow 3A$

4. Ordering Information

Part Number	Description
RTKA489118DE0000BU	RAA489118 Evaluation Board - No BFET
RTKA489118DE0010BU	RAA489118 Evaluation Board – with BFET

5. Revision History

Revision	Date	Description
1.02	Sep 26, 2025	Updated figures 18, 19, 29, and 30.
1.01	Nov 14, 2024	Updated board photos, schematic, and BOMs.
1.00	Jun 10, 2024	Initial release

IMPORTANT NOTICE AND DISCLAIMER

RENESAS ELECTRONICS CORPORATION AND ITS SUBSIDIARIES (“RENESAS”) PROVIDES TECHNICAL SPECIFICATIONS AND RELIABILITY DATA (INCLUDING DATASHEETS), DESIGN RESOURCES (INCLUDING REFERENCE DESIGNS), APPLICATION OR OTHER DESIGN ADVICE, WEB TOOLS, SAFETY INFORMATION, AND OTHER RESOURCES “AS IS” AND WITH ALL FAULTS, AND DISCLAIMS ALL WARRANTIES, EXPRESS OR IMPLIED, INCLUDING, WITHOUT LIMITATION, ANY IMPLIED WARRANTIES OF MERCHANTABILITY, FITNESS FOR A PARTICULAR PURPOSE, OR NON-INFRINGEMENT OF THIRD-PARTY INTELLECTUAL PROPERTY RIGHTS.

These resources are intended for developers who are designing with Renesas products. You are solely responsible for (1) selecting the appropriate products for your application, (2) designing, validating, and testing your application, and (3) ensuring your application meets applicable standards, and any other safety, security, or other requirements. These resources are subject to change without notice. Renesas grants you permission to use these resources only to develop an application that uses Renesas products. Other reproduction or use of these resources is strictly prohibited. No license is granted to any other Renesas intellectual property or to any third-party intellectual property. Renesas disclaims responsibility for, and you will fully indemnify Renesas and its representatives against, any claims, damages, costs, losses, or liabilities arising from your use of these resources. Renesas' products are provided only subject to Renesas' Terms and Conditions of Sale or other applicable terms agreed to in writing. No use of any Renesas resources expands or otherwise alters any applicable warranties or warranty disclaimers for these products.

(Disclaimer Rev.1.01)

Corporate Headquarters

TOYOSU FORESIA, 3-2-24 Toyosu,
Koto-ku, Tokyo 135-0061, Japan
www.renesas.com

Trademarks

Renesas and the Renesas logo are trademarks of Renesas Electronics Corporation. All trademarks and registered trademarks are the property of their respective owners.

Contact Information

For further information on a product, technology, the most up-to-date version of a document, or your nearest sales office, please visit www.renesas.com/contact-us/.