

# DA16200 DA16600 FreeRTOS Getting Started Guide

The DA16200/DA16600 is a highly integrated ultra-low-power Wi-Fi system on chip (SoC) that allows developing a complete Wi-Fi solution on a single chip. This document is a DA16200/DA16600 getting started guide intended to help new or existing developers quickly get started using the EVK and SDK to develop Wi-Fi applications with the DA16200/DA16600 chipset.

## Contents

<b>Contents</b> .....	<b>1</b>
<b>Figures</b> .....	<b>3</b>
<b>Tables</b> .....	<b>5</b>
<b>1. Terms and Definitions</b> .....	<b>6</b>
<b>2. References</b> .....	<b>6</b>
<b>3. Overview</b> .....	<b>7</b>
<b>4. Evaluation Kit</b> .....	<b>8</b>
4.1 Introduction.....	8
4.2 DA16200 EVB V11.0.....	8
4.3 DA16600 EVB V6.0.....	11
4.4 EVB Setup.....	14
4.4.1 Configuring DA16200/DA16600 Serial Debug Interface .....	15
4.4.2 Configuring DA14531 Serial Debug Interface .....	16
4.5 Firmware Image Programming.....	17
4.5.1 Use uart_program_da16200 in Console Terminal.....	18
4.5.2 Use Macro Script of Tera Term .....	21
4.5.3 Use Multi-Download Tool.....	23
4.5.4 Change Boot Index .....	23
4.5.5 GPIOs for Pre-built Images.....	24
4.6 Wi-Fi Provisioning .....	25
4.6.1 Station Mode Setup .....	25
4.6.2 Soft AP Mode Setup .....	27
4.6.3 Wi-Fi Provisioning Setup Using Bluetooth® LE .....	30
4.7 Configuring UART/SPI as AT Command Interface .....	30
4.7.1 Configuration for Testing AT Command with EVB Only .....	31
4.7.2 Configuration for Testing AT Command with External MCU .....	32
<b>5. Software Development Kit</b> .....	<b>35</b>
5.1 Introduction.....	35
5.2 System Requirements .....	35
5.3 Install e <sup>2</sup> studio IDE .....	35
5.4 Import DA16200 FreeRTOS SDK Project into e <sup>2</sup> studio .....	37
5.5 Build Projects .....	41
5.5.1 Build Configurations.....	43

5.5.2	Change Flash Configuration .....	45
5.5.3	How to Move Project Location .....	46
5.6	Debugging with J-Link Debug Probe.....	47
5.6.1	Install J-Link .....	47
5.6.2	Connect J-Link .....	48
5.6.3	Run Debug Mode.....	49
5.7	Program Firmware Images in e <sup>2</sup> studio .....	50
5.7.1	Import Launches for Programming Firmware Images .....	50
5.7.2	Program Firmware Images over Serial Interface .....	52
5.7.3	Program Firmware Images Using SEGGER J-Link.....	54
5.8	Migrate IDE from Eclipse to e <sup>2</sup> studio for Old SDKs.....	55
<b>6.</b>	<b>Test Procedures .....</b>	<b>56</b>
6.1	Introduction.....	56
6.2	Ping Test .....	56
6.2.1	Test Setup.....	56
6.2.2	Perform Ping Test with DPM Enabled .....	57
6.2.3	Add ARP Record.....	58
6.3	Throughput Test.....	59
6.3.1	Test Setup.....	59
6.3.2	Throughput Test with DA16200/DA16600 as Client.....	61
6.3.3	Throughput Test with DA16200/DA16600 as Server .....	62
6.4	Current Test .....	63
6.4.1	Test Setup – KEYSIGHT 14585A.....	64
6.4.2	Test Setup with EVK Pro Board.....	64
6.4.3	Measure Current in Sleep Mode 1 .....	69
6.4.4	Measure Current in Sleep Mode 2 .....	69
6.4.5	Measure Current in Sleep Mode 3.....	70
6.4.6	Measure Current in DPM Low Power Mode .....	70
6.4.7	DPM Setup.....	70
<b>Appendix A</b>	<b>Old Versions of EVB.....</b>	<b>75</b>
A.1	DA16200 EVB V10.0.....	75
A.2	DA16200 EVB V9.0.....	78
A.3	DA16600 EVB V5.0.....	80
A.4	DA16600 EVB V4.0.....	83
A.5	Configure DA16600 EVB V4.0 to Use AT Commands Using UART2 .....	85
A.5.1	Turn Off Switch .....	85
A.5.2	Connect UART2 to FT2232H.....	86
<b>Appendix B</b>	<b>DA16200 Debug Interface Commands .....</b>	<b>88</b>
B.1	Console Command.....	88
B.1.1	Root Commands .....	88
B.1.2	Network Commands .....	89
B.2	CLI Command .....	91
B.2.1	Overview .....	91
B.2.2	CLI Format .....	91
B.2.3	Common Commands .....	92

B.2.4	STA Commands.....	94
B.2.5	Soft AP Commands .....	94
B.2.6	Advanced Commands.....	98
B.3	MROM Command .....	98
B.3.1	Common Commands.....	98
B.3.2	Memory Access Commands.....	98
B.3.3	Download Commands.....	98
B.3.4	SFlash Commands .....	99
B.3.5	Secure Commands .....	99
B.3.6	Additional Commands.....	99
<b>Appendix C</b>	<b>SDK Memory Maps .....</b>	<b>100</b>
C.1	SFlash Memory Map .....	100
C.1.1	DA16200 .....	100
C.1.2	DA16600 .....	100
C.2	SRAM Map .....	102
<b>Appendix D</b>	<b>Troubleshooting .....</b>	<b>103</b>
D.1	Boot Failure .....	103
D.1.1	Check SFDP .....	103
D.1.2	Recovery from Unresponsive Boot.....	103
<b>Appendix E</b>	<b>Country Codes .....</b>	<b>106</b>
<b>7.</b>	<b>Revision History .....</b>	<b>108</b>

## Figures

Figure 1.	DA16200 EVB hardware configuration.....	8
Figure 2.	J2, J5 – GPIO external pinout .....	8
Figure 3.	J7 – JTAG Connector.....	9
Figure 4.	P2 – Jumper to measure current consumption of the DA16200 .....	9
Figure 5.	DA16600 EVB hardware configuration.....	11
Figure 6.	J7 & CN7 – JTAG connector .....	12
Figure 7.	J2 – external pinout .....	12
Figure 8.	J3 – external pinout .....	12
Figure 9.	Windows – COM ports.....	15
Figure 10.	Serial port setup in Tera Term.....	21
Figure 11.	Open macro file .....	22
Figure 12.	Programming FBOOT image.....	22
Figure 13.	Programming FRTOS image.....	23
Figure 14.	Diagram of provisioning through Bluetooth® LE .....	30
Figure 15.	Configure DA16200 EVB for AT command – UART to FT2232H.....	31
Figure 16.	Configure DA16600 EVB for AT command – UART to FT2232H.....	32
Figure 17.	Configure DA16200 EVB for AT command – UART/SPI to external MCU.....	32
Figure 18.	Configure DA16600 EVB for AT command – UART/SPI with external MCU.....	33
Figure 19.	Download e <sup>2</sup> studio installer .....	35
Figure 20.	Run e <sup>2</sup> studio installer .....	36
Figure 21.	e <sup>2</sup> studio setup .....	36
Figure 22.	Installing GNU Arm® Embedded Toolchain.....	37
Figure 23.	Import SDK project to e <sup>2</sup> studio IDE .....	37
Figure 24.	Import project.....	38
Figure 25.	Select folder to import SDK project into e <sup>2</sup> studio IDE.....	38
Figure 26.	Import DA16200/DA16600 project to e <sup>2</sup> studio IDE.....	39
Figure 27.	Import SDKJFlash project to e <sup>2</sup> studio IDE.....	39
Figure 28.	Dialog SDK project .....	40

Figure 29. e <sup>2</sup> studio project explorer .....	41
Figure 30. Build project.....	41
Figure 31. Generate configuration .....	42
Figure 32. Generate configuration warning pop-up .....	42
Figure 33. Location of firmware image files .....	43
Figure 34. DA16200 build configurations .....	44
Figure 35. DA16600 build configurations .....	45
Figure 36. Import launch configuration .....	45
Figure 37. Import generate configuration .....	46
Figure 38. Run generate configuration .....	46
Figure 39. SDK root path variables .....	47
Figure 40. Download J-Link software .....	47
Figure 41. J-Link 9-pin Cortex-M Adapter .....	48
Figure 42. Configure built-in JTAG for DA16200.....	49
Figure 43. Run Debug mode .....	49
Figure 44. Select debug configuration.....	50
Figure 45. Python command.....	50
Figure 46. Import launches .....	51
Figure 47. Browse folder.....	51
Figure 48. Select launch configurations .....	52
Figure 49. Launch configurations for programming firmware images .....	52
Figure 50. Select number from serial interface list .....	53
Figure 51. Programming firmware image over serial interface.....	53
Figure 52. Emergency mode for programming firmware image .....	54
Figure 53. Run J-Link launch.....	55
Figure 54. Ping test environment.....	56
Figure 55. Throughput test environment .....	59
Figure 56. Disable firewall for iPerf test.....	62
Figure 57. Current test environment with 14585A.....	64
Figure 58. Current test environment with EVK Pro for DA16200 .....	64
Figure 59. Set up DA16200 EVB jumper .....	64
Figure 60. Current test environment with EVK Pro for DA16600 .....	65
Figure 61. Set up DA16600 EVB jumper.....	65
Figure 62. DA16200/DA16600 EVK Pro board (504-02-A).....	65
Figure 63. Select virtual COM port .....	66
Figure 64. Power Profiler of SmartSnippets Toolbox .....	66
Figure 65. Power Profiler configuration .....	67
Figure 66. Power Profiler chart settings .....	67
Figure 67. Free running capture .....	68
Figure 68. Measuring consumption by using chart controls .....	68
Figure 69. Setting offset to zero .....	69
Figure 70. Setting calibration offset .....	69
Figure 71. Measuring current in DPM low power mode .....	70
Figure 72. DA16200 EVB hardware configuration.....	75
Figure 73. J7 – JTAG Connector.....	75
Figure 74. Jumper to measure current consumption of the DA16200 .....	76
Figure 75. J2, J5 – external pinout .....	76
Figure 76. DA16200 EVB V9.0 hardware configuration .....	78
Figure 77. J7 – JTAG Connector.....	78
Figure 78. P2 – Jumper to Measure Current Consumption of the DA16200 .....	79
Figure 79. J3, J4 – external connector .....	79
Figure 80. DA16600 EVB hardware configuration.....	80
Figure 81. J7 – JTAG Connector.....	81
Figure 82. J2,J3 – External Pinout .....	82
Figure 83. DA16600 EVB V4.0 hardware configuration .....	83
Figure 84. J7 - JTAG Connector.....	84
Figure 85. J2,14 - Connector.....	84
Figure 86. SW3 and SW7 UART1 connection.....	86
Figure 87. Connect UART2 to FT2232H .....	86
Figure 88. Modification and connection of EVB V4.0 .....	87

Figure 89. System memory map..... 102

## Tables

Table 1. Components on DA16200 EVB ..... 8  
 Table 2. DA16200 EVB switch description ..... 10  
 Table 3. Components on DA16600 EVB ..... 11  
 Table 4. DA16600 EVB switch description ..... 14  
 Table 5. Serial port configuration values ..... 15  
 Table 6. Debug switch settings ..... 16  
 Table 7. Debug console settings ..... 17  
 Table 8. Serial flash memory map ..... 18  
 Table 9. Firmware images vs GPIOs ..... 24  
 Table 10. Default GPIO pin settings of UART and SPI ..... 31  
 Table 11. Configure DA16200 EVB switch for AT command – UART to FT2232H ..... 31  
 Table 12. DA16600 EVB switch configuration for AT command – UART to FT2232H ..... 32  
 Table 13. Configure DA16200 EVB switch for AT command – UART/SPI with external MCU ..... 32  
 Table 14. Configure DA16200 EVB connector for AT command – UART/SPI with external MCU ..... 33  
 Table 15. Configure DA16600 EVB switch for AT command – UART/SPI with external MCU ..... 33  
 Table 16. Configure DA16600 EVB connector for AT command – UART/SPI with external MCU ..... 33  
 Table 17. Components on DA16200 EVB ..... 75  
 Table 18. DA16200 EVB switch description ..... 77  
 Table 19. Components on DA16200 EVB ..... 78  
 Table 20. GPIO and SPI selection switch ..... 79  
 Table 21. Components on DA16600 EVB ..... 80  
 Table 22. DA16600 EVB switch description ..... 82  
 Table 23. Components on DA16600 EVB ..... 83  
 Table 24. Description of switches ..... 84  
 Table 25. Root commands ..... 88  
 Table 26. Network commands ..... 89  
 Table 27. CLI commands in common mode ..... 92  
 Table 28. CLI commands on STA mode ..... 94  
 Table 29. CLI commands on Soft AP mode ..... 94  
 Table 30. Advanced CLI commands ..... 98  
 Table 31. Common commands in MROM ..... 98  
 Table 32. Memory access commands in MROM ..... 98  
 Table 33. Download commands in MROM ..... 98  
 Table 34. SFlash commands in MROM ..... 99  
 Table 35. Secure commands in MROM ..... 99  
 Table 36. Additional commands in MROM ..... 99  
 Table 37. 4 MB SFlash map for DA16200 ..... 100  
 Table 38. 4 MB SFlash map for DA16600 ..... 100  
 Table 39. Country codes ..... 106

## 1. Terms and Definitions

AP	Access Point
BSS	Basic Service Set
BUFP	Buffering Probe
COM	Communication Port
DDPS	DPM Dynamic Period Setting
DPM	Dynamic Power Management
EVB	Evaluation Board
EVK	Evaluation Kit
GND	Ground
IDE	Integrated Development Environment
JDK	Java Development Kit
OTA	Over the Air
RTOS	Real Time Operating System
SDK	Software Development Kit
SFDP	Serial Flash Discoverable Parameter
SoC	System on Chip
SSID	Service Set Identifier
TIM	Traffic Indication Map
UART	Universal Asynchronous Receiver/Transmitter
UC	Unicast Packet

## 2. References

- [1] DA16200, Datasheet, Renesas Electronics.
- [2] UM-WI-046, DA16200 DA16600 FreeRTOS SDK Programmer Guide, Manual, Renesas Electronics.
- [3] UM-B-114, DA14531 Devkit Pro Hardware, Manual, Renesas Electronics.
- [4] UM-WI-012, DA16200 SPI SFlash Downloader, Manual, Renesas Electronics.
- [5] UM-WI-003, DA16200 DA16600 Host Interface and AT Command, Manual, Renesas Electronics.
- [6] UM-WI-061, DA16200 DA16600 Getting Started with AWS-IoT Core, Manual, Renesas Electronics.
- [7] UM-WI-039, DA16200 DA16600 MultiDownloader, Manual, Renesas Electronics.
- [8] UM-WI-042, DA16200 DA16600 Provisioning Mobile App, Manual, Renesas Electronics.
- [9] DA16200 DEVKT Electric Schematic, Renesas Electronics.
- [10] DA16600 DEVKT Electric Schematic, Renesas Electronics.
- [11] UM-WI-006, DA16200 DA16600 Hardware Design Guide, Manual, Renesas Electronics.

**Note 1** References are for the latest published version, unless otherwise indicated.

### 3. Overview

The DA16200/DA16600 is a highly integrated ultra-low-power Wi-Fi system on chip (SoC) that allows you to develop Wi-Fi solutions using a single chip. Evaluation Kits (EVK) and SDKs are provided to simplify the process of starting a project with the DA16200 or the DA16600.

This document provides step by step guides to start using the EVK and Software Development Kit (SDK) by providing details on:

- DA16200 and DA16600 EVK (see Section 4)
- Setting Up EVB (see Section 4.4)
- Programming Firmware Images (see Section 4.5)
- Provisioning Wi-Fi (see Section 4.6)
- Configuring Software Development Tools (see Section 5)
- Debugging Applications (see Section 5.6)
- Conducting Various Tests with DA16200/DA16600 (see Section 6)

After completing these steps, the EVK and development environment are ready for developing a complete Wi-Fi solution.

If Wi-Fi solutions that are being developed are based on a host MCU that only uses the DA16200/DA16600 as a Wi-Fi communication interface with AT commands, a prebuilt firmware image can be used to develop that solution. For details on how to use AT commands, see Ref. [5] and Ref. [6].

If Wi-Fi solutions that are being developed require special functions or it is a standalone solution using only the DA16200/DA16600, for how to use and update the SDK to develop an application, see Ref. [2].



## 4. Evaluation Kit

### 4.1 Introduction

The DA16200 and DA16600 EVKs are designed for you to test and develop Wi-Fi applications quickly. The EVK contains:

- Evaluation board: The specific board with DA16200MOD or DA16600MOD installed.
- USB cable.

### 4.2 DA16200 EVB V11.0

Figure 1 shows the hardware configuration of the DA16200 EVB.

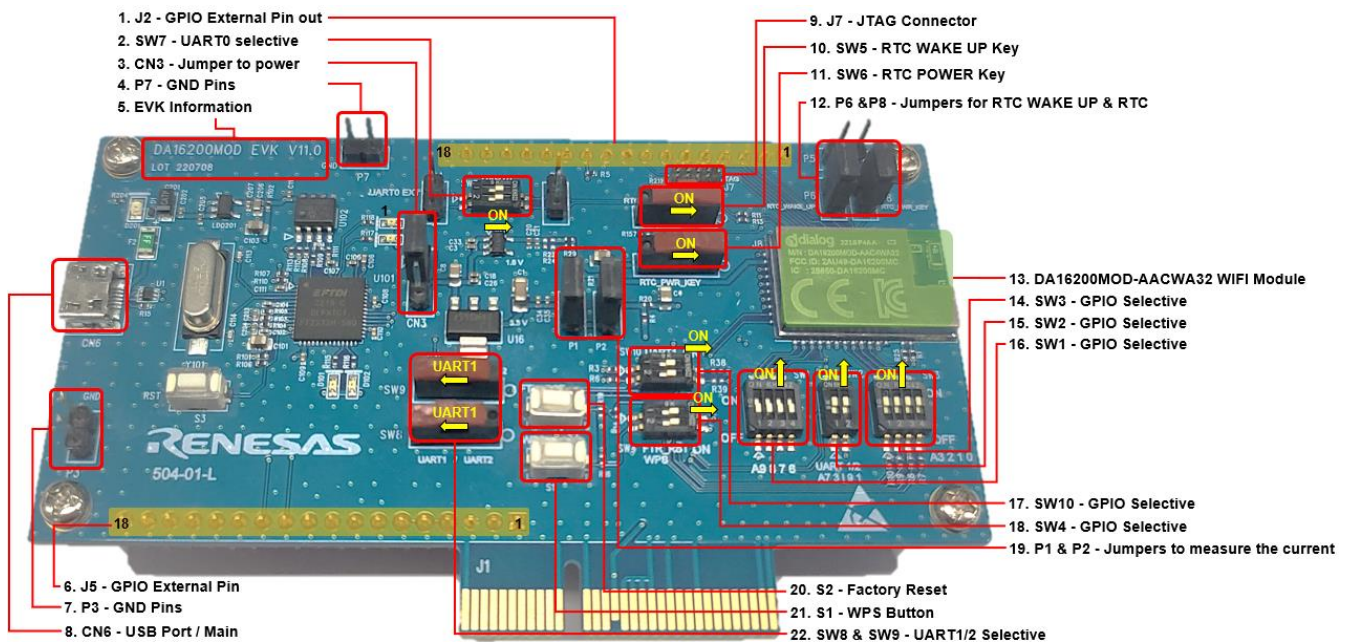

Figure 1. DA16200 EVB hardware configuration

Table 1 shows the DA16200 EVB V11.0 components.

Table 1. Components on DA16200 EVB

No	Name	Description
1	J2, J5 – GPIO External Pinout	

Figure 2. J2, J5 – GPIO external pinout

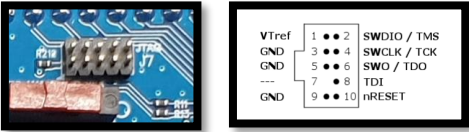
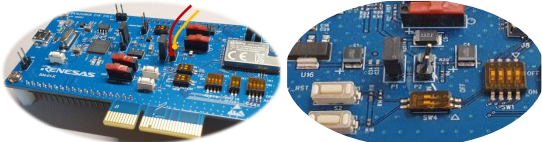

No	Name	Description
2	SW7– UART0 Selection Switch	UART0 selection switch, default ON. See <a href="#">Table 2</a> .
3	CN3 – Jumper to Power	5 V power selection from USB or External.
4	P7 – GND Pins	Ground.
5	Board Information	Board version and manufacturing date.
6	P3 – GND Pins	Ground.
7	CN6 – USB Port	Provide UART0 for debug, and UART1/2 for test and SPI.
8	J7 – JTAG Connector	Connector for the JTAG Debugger. ( <a href="#">Note 1</a> )
		
<b>Figure 3. J7 – JTAG Connector</b>		
9	SW5 – RTC_WAKE_UP Switch	Switch to wake up the board from Sleep mode.
10	SW6 – RTC_PWR_KEY Switch	Switch to turn the EVB ON and OFF.
11	P6 – Jumpers for RTC_WAKE_UP1	Pin for connecting the external control signal with MCU. For normal operation, this jumper should be shorted.
12	DA16200MOD-AACWA32	Renesas <b>Wi-Fi Module</b> .
13	SW3 – GPIO Selection Switch	GPIO selection switch, default OFF. See <a href="#">Table 2</a> .
14	SW2 – GPIO Selection Switch	GPIO selection switch, default ON. See <a href="#">Table 2</a> .
15	SW1 – GPIO Selection Switch	GPIO selection switch, default OFF. See <a href="#">Table 2</a> .
16	SW10 – GPIO Selection Switch	GPIO selection switch, default ON. See <a href="#">Table 2</a> .
17	SW4 – GPIO Selection Switch	GPIO selection switch, default ON. See <a href="#">Table 2</a> .
18	P1 – External VDD	External VDD (3.3 V) can be supplied to the P1 pins. For normal operation, this jumper should be shorted.
	P2 – Jumper to Measure Current Consumption of the DA16200	Pin for current measurement. For normal operation, this pin should be shorted. <ul style="list-style-type: none"> <li>▪ Pull out the Short Pin cap and use jumper wires to connect to the measuring equipment.</li> <li>▪ Pull out the Short Pin cap to the measuring Pro board.</li> </ul>
		
<b>Figure 4. P2 – Jumper to measure current consumption of the DA16200</b>		
19	S2 – Factory Reset Button	Factory Reset button using GPIOA_7. To enable this button, set Pin 2 of SW4 to ON. Press the button for at least 5 s to delete <code>nvr</code> data and certificates, and perform software reboot, which should be rebooted in concurrent mode by default.
20	S1 – WPS Button	WPS button using GPIOA_6. To enable this button, set Pin 1 of SW4 to ON and press the button to start WPS mode.
21	SW8, SW9 – UART1/2 Selection Switch	UART1/2 selection switch, default LEFT (UART1). See <a href="#">Table 2</a> .

**Note 1** The pin 7 of the I-jet debugger cable is keyed with a white plug so the pin 7 must be removed from the EVB.

Table 2. DA16200 EVB switch description

Switch	Pin	Relevant GPIO	ON	OFF	Default
SW1	1	GPIOA6	Connect FT2232H to SPI_CSB (Note 1)	WPS	OFF
	2	GPIOA7	Connect FT2232H to SPI_CLK (Note 1)	Factory reset	
	3	GPIOA8	Connect FT2232H to SPI_MISO (Note 1)	External pinout (J2/J5) only	
	4	GPIOA9	Connect FT2232H to SPI_MOSI (Note 1)		
SW2	1	GPIOA4	Connect FT2232H to UART1_TXD	External pinout (J2/J5) only	ON
	2	GPIOA5	Connect FT2232H to UART1_RXD		
SW3	1	GPIOA0	Connect FT2232H to SPI_CSB (Note 1)	External pinout (J2/J5) only	OFF
	2	GPIOA1	Connect FT2232H to SPI_CLK (Note 1)		
	3	GPIOA2	Connect FT2232H to SPI_MISO (Note 1)		
	4	GPIOA3	Connect FT2232H to SPI_MOSI (Note 1)		
SW4	1	GPIOA6	WPS	External pinout (J2/J5) only	ON
	2	GPIOA7	Factory reset		
SW7	1	UART0_TXD	Connect FT232H to UART0_TXD	NC	ON
	2	UART0_RXD	Connect FT232H to UART0_RXD		
SW8		GPIOA4	Not available on DA16200 EVB V11.0 (Right)	Connect SW2 to SW10 (Left)	LEFT
SW9		GPIOA5	Not available on DA16200 EVB V11.0 (Right)	Connect SW2 to SW10 (Left)	LEFT
SW10	1	GPIOA4	Connect SW8 to UART1_TXD	External pinout (J2/J5) only	ON
	2	GPIOA5	Connect SW9 to UART1_RXD		

**Note 1** By default, the SPI interface is configured to support firmware download through the FT2232H. For details on how to configure the EVB to support AT command processing from an MCU directly connected to the SPI interface, see Section 4.7.

The current consumption can be measured on the P2 jumper using current measuring equipment. For details on the test setup, see Section 6.4. When the DA16200 EVK Pro is used for measuring current consumption, the P1 jumper must be removed. For more information on the DA16200 EVK Pro, see Section 6.4.2, and for DA16200 EVB, see Ref. [9].

### 4.3 DA16600 EVB V6.0

Figure 5 shows the hardware configuration of the DA16600 EVB.

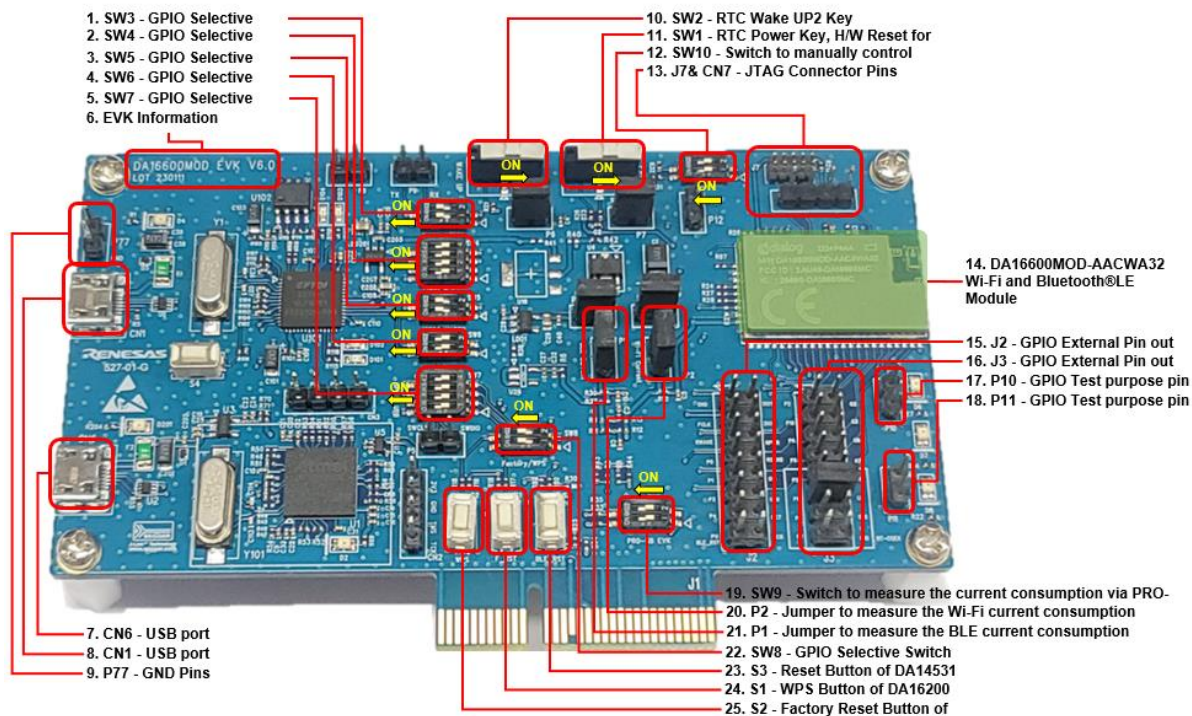
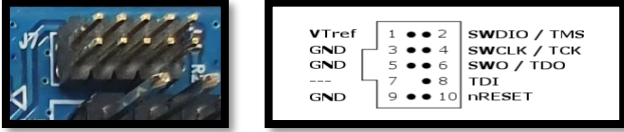
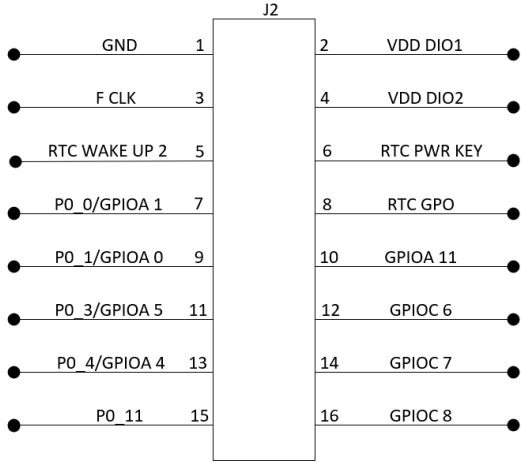
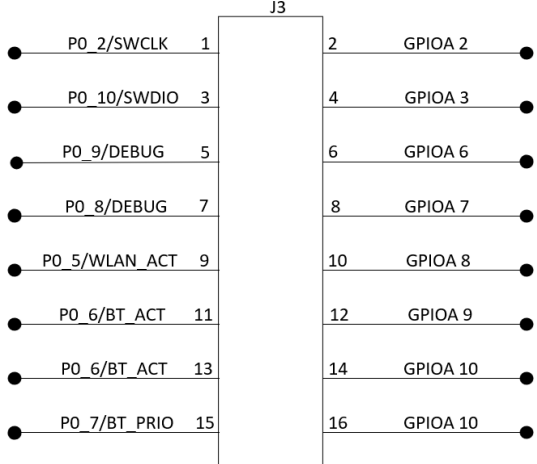

Figure 5. DA16600 EVB hardware configuration

Table 3 shows the DA16600 EVB components.

Table 3. Components on DA16600 EVB

No	Name	Description
1	SW3 – GPIO Selective Switch	GPIO selection switch, default ON. See Table 4.
2	SW4 – GPIO Selective Switch	GPIO selection switch, default OFF. See Table 4.
3	SW5 – GPIO Selective Switch	GPIO selection switch, default ON. See Table 4.
4	SW6 – GPIO Selective Switch	GPIO selection switch, default OFF. See Table 4.
5	SW7 – GPIO Selective Switch	GPIO selection switch, default OFF. See Table 4.
6	Board Information	Board version and manufacturing date.
7	CN6 – USB Port (Bluetooth)	Connect directly to DA14531 for debugging only. (Note 1)
8	CN1 – USB Port (Wi-Fi)	Provide UART0 for debug and UART2 for other purposes.
9	P77 – GND Pins	Ground.
10	SW2 – RTC Wake Up2 key	Switch to wake up the board from Sleep mode.
11	SW1 – RTC Power key	Switch to turn the EVB ON and OFF.
12	SW10 – Switch to Control the SPDT	Switch to control RF switch of DA16600MOD in test mode, default OFF.
13	J7 & CN7 – JTAG Connector	Connector for JTAG Debugger. (Note 2)

No	Name	Description
		 <p style="text-align: center;"><b>Figure 6. J7 &amp; CN7 – JTAG connector</b></p>
14	DA16600MOD-AACWA32	Renesas Wi-Fi and Bluetooth® LE Module.
15	J2 – External Pinout	 <p style="text-align: center;"><b>Figure 7. J2 – external pinout</b></p>
16	J3 – External Pinout	 <p style="text-align: center;"><b>Figure 8. J3 – external pinout</b></p> <p>P0_6 (Pin #11) should be connected to GPIOA9 (Pin #12) or GPIOA10 (Pin #14) externally for Wi-Fi and Bluetooth® LE coexistence.</p>
17	P10 – Jumper to Test GPIO	GPIO test pin. By connecting the GPIOs of J2/J3 to P10, operation can be checked with LED.
18	P11 – Jumper to Test GPIO	GPIO test pin. By connecting the GPIOs of J2/J3 to the above pin of P10, operation can be checked with LED. The bottom pin of P11 is set to GND.
19	SW9 – Switch to Test Current Consumption	Switch to test current consumption using a Pro board kit, default OFF.
20	P2 – Jumper to Measure Current Consumption of DA16200	Jumper to measure current used by the Wi-Fi device. For normal operation, this jumper must be shorted.

No	Name	Description
21	P1 – Jumper to Measure Current Consumption of DA14531	Jumper to measure current used by the Bluetooth® LE device. For normal operation, this jumper must be shorted.
22	SW8 – GPIO Selective Switch	GPIO selection switch, default ON. See <a href="#">Table 4</a> .
23	S3 – DA14351 Reset Button	Reset button of DA14531 in test mode.
24	S1 – WPS Button	WPS button using GPIOA6. To enable this button, set Pin 1 of SW7 to ON and press the button to start WPS mode.
25	S2 – Factory Reset Button	Factory Reset button using GPIOA_7. To enable this button, set Pin 2 of SW4 to ON. Press the button for at least 5 s to delete <i>nvsram</i> data and certificates, and perform software reboot, which should be rebooted in concurrent mode by default.

**Note 1** Do not use this port during normal operation.

**Note 2** The pin 7 on the I-Jet debugger cable is keyed with a white plug so the pin 7 must be removed from the EVB.

DA16600 EVB includes several switches, see the descriptions in [Table 4](#) for each switch.

**Table 4. DA16600 EVB switch description**

Switch	Pin	Relevant pin	ON	OFF	Default	
SW3	1	DA16200	UART0_RXD	Connect FT232H to UART0_RXD	NC	ON
	2		UART0_TXD	Connect FT232H to UART0_TXD		
SW4	1	DA14531	P0_8	Connect FT2232H to P0_8 (UART_RXD)	External pinout (J2/J3) only	OFF
	2		P0_9	Connect FT2232H to P0_9 (UART_TXD)		
	3		P0_2	Enable Keil toolchain debug of DA14531 (SWCLK)		
	4		P0_10	Enable Keil toolchain debug of DA14531 (SWDIO)		
SW5	1	DA16200	GPIOC6	Connect FT2232H to UART2_TXD	External pinout (J2/J3) only	ON
	2		GPIOC7	Connect FT2232H to UART2_RXD		
SW6	1	DA14531	P0_5	Connect FT2232H to P0_5 (1-wire UART)	External pinout (J2/J3) only	OFF
	2			Connect FT2232H to P0_5 (1-wire UART)		
SW7	1	DA16200	GPIOA6	Not available on DA16600 EVB V5.0	External pinout (J2/J3) only	OFF
	2		GPIOA7			
	3		GPIOA8			
	4		GPIOA9			
SW8	1	DA16200	GPIOA6	WPS	External pinout (J2/J3) only	ON
	2		GPIOA7	Factory reset		
SW9	1	DA16200	Measuring current consumption	Enable to measure current consumption of the DA16200 with EVK Pro. Need to remove jumper P2	Normal operation/Need to connect P2	OFF
	2	DA14531	Measuring current consumption	Enable to measure current consumption of the DA14531 with EVK Pro. Need to remove jumper P1	Normal operation/Need to connect P1	
SW10	1	DA14531	P0_6	Manual control of the internal RF SPDT.		OFF
	2			Pin 1 OFF and Pin 2 OFF: Internally controlled Pin 1 ON and Pin 2 OFF: DA14531 RF path ON Pin 1 OFF and Pin 2 ON: DA16200 RF path ON		

The current consumption can be measured on the P1 and P2 jumpers using current measuring equipment. For details on the test setup, see [Section 6.4](#).

When DA16600 EVK Pro is used for measuring current consumption, remove jumpers P1 and P2 and set pins 1 and 2 of SW9 to the ON position. To measure the current consumption of the DA16200, remove the jumper on P2 and turn ON pin 1 of SW9. To measure the current consumption of DA14531, remove the jumper on P1 and turn ON pin 2 of SW9. The current consumption of the DA16200 and the DA14531 can be measured simultaneously. For more information on the DA16600 EVB, see [Ref. \[10\]](#).

## 4.4 EVB Setup

Before setting up the Evaluation Board (EVB), ensure that the EVB and the required software are properly connected and installed. To establish a connection, use the USB cable included in the EVK to connect the host computer and the EVB.



### 4.4.1 Configuring DA16200/DA16600 Serial Debug Interface

The DA16200/DA16600 provides a command/debug interface on UART0 for performing configuration and diagnostic functions. When the EVB is connected to the USB port (**CN6** on the DA16200 EVB or **CN1** on the DA16600 EVB), open Device Manager to see whether two virtual COM ports are created.

- For Windows, the two COM ports are displayed in the Device Manager (see [Figure 9](#)).

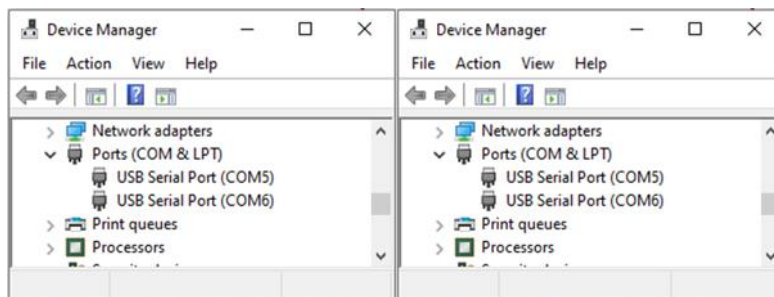

Figure 9. Windows – COM ports

**NOTE**

If Windows Device Manager displays **Unknown Device**, the FTDI serial driver is not installed. Download the driver from the following URL and install it manually: [http://www.ftdichip.com/Drivers/CDM/CDM21224\\_Setup.zip](http://www.ftdichip.com/Drivers/CDM/CDM21224_Setup.zip).

- For Linux, the COM ports are created in the /dev directory as ttyUSBx devices.

```
$
$ ls -l /dev/ttyU*           List the available ttyUSB serial ports.
crw-rw---- 1 root dialout 188, 0 Aug 25 10:26 /dev/ttyUSB0
crw-rw---- 1 root dialout 188, 1 Aug 25 10:26 /dev/ttyUSB1
$
```

The lower numbered COM port (COM5 in [Figure 9](#)) is for the DA16200/DA16600 debug interface. The higher numbered COM port is for the DA16200/DA16600 AT command interface.

**NOTE**

On the DA16600, the higher numbered COM port can also be configured as the DA14531 serial debug interface. See [Section 4.4.2](#).

A serial terminal application can be used for debugging the DA16200/DA16600.

- For Windows, the **Tera Term** terminal emulator program is recommended and can be downloaded from: <https://tssh2.osdn.jp>.
- For Linux, the **minicom** terminal emulation program is recommended and can be installed using:

```
$
$ sudo apt install minicom   Command to install minicom.
$
```

When the terminal emulation application is installed, connect the USB cable to the EVB (**CN6** on the DA16200 EVB or **CN1** on DA16600 EVB) and start the terminal emulation program.

In the terminal emulation program, go to the **Serial Port Setup** and select the lower numbered COM port and configure it as follows.

Table 5. Serial port configuration values

Settings	Value
Baud Rate	230400
Data Bits	8
Parity	None
Stop Bits	1



Settings	Value
Flow Control (Hardware/Software)	None

Turn ON the EVB (**SW6** on the DA16200 EVB or **SW2** on the DA16600 EVB) and check for output. See the following example for reference.

```

Wakeup source is 0x4
[dpm_init_retmemory] DPM INIT CONFIGURATION(1)
*****
*           DA16200 SDK Information
* -----
*
* - CPU Type       : Cortex-M4 (120 MHz)
* - OS Type        : FreeRTOS 10.4.3
* - Serial Flash   : 4 MB
* - SDK Version    : V3.1.3.0 GEN
* - F/W Version    : FRTOS-GEN01-01-15129-000000
* - F/W Build Time : Aug 26 2021 22:58:01
* - Boot Index     : 0
*
*****
System Mode : Station Only (0)
>>> DA16x Supp Ver2.7 - 2020_07
>>> MAC address (sta0) : d4:3d:39:10:a2:48
>>> sta0 interface add OK
>>> Start STA mode...
[/DA16200] #
    
```

You can enter commands in the [/`DA16200`] prompt. A full list of the available debug interface commands can be found in [Appendix B](#).

#### 4.4.2 Configuring DA14531 Serial Debug Interface

This section is for DA16600 only and is required for special cases where access to the DA14531 Bluetooth devices debug terminal is needed.

The DA16600 EVB contains the DA14531 Bluetooth device which is used for provisioning the DA16600 Wi-Fi interface using a mobile application. On the DA16600 EVB, the DA14531 debug interface can be connected to the higher numbered COM port that is created when the USB cable is connected to **CN1**.

To enable the DA14531 debug interface, follow the settings in [Table 6](#) for **SW4**, **SW5**, **SW6** and **SW7**.

**Table 6. Debug switch settings**

Switch	Pin	Relevant pin	ON	Default	
SW4	1	DA14531	P0_8	Connect FT2232H to P0_8 (UART_RXD)	ON
	2		P0_9	Connect FT2232H to P0_9 (UART_TXD)	
	3	DA16200	P0_2	Enable Keil toolchain debug of DA14531 (SWCLK)	Don't care
	4		P0_10	Enable Keil toolchain debug of DA14531 (SWDIO)	
SW5	1	DA16200	GPIOC6	Connect FT2232H to UART2_TXD	OFF
	2		GPIOC7	Connect FT2232H to UART2_RXD	

Switch	Pin	Relevant pin		ON	Default
SW6	1	DA14531	P0_5	Connect FT2232H to P0_5 (1-wire UART)	OFF
	2			Connect FT2232H to P0_5 (1-wire UART)	
SW7	1	DA16200	GPIOA6	Not available on DA16600 EVB V5.0	OFF
	2		GPIOA7		
	3		GPIOA8		
	4		GPIOA9		

When the switches are set properly, open a serial terminal application, and select the higher numbered COM port. Configure the higher numbered COM port as follows:

**Table 7. Debug console settings**

Settings	Value
Baud Rate	115200
Data Bits	8
Parity	None
Stop Bits	1
Flow Control (Hardware/Software)	None

Open a second serial terminal application and connect to the DA16200 debug console and run the `reboot` command. Then, the following output appears in the DA14531 debug console:

```
user_on_init
```

**NOTE**

The `uart_program_da16200` in the following section can be used for debugging console of the DA16200, but it cannot be used with DA14531. Other console programs like Tera Term or minicom can be used for DA14531 debug console.

## 4.5 Firmware Image Programming

When using an EVB for the first time, the firmware version in the EVB is the version when the EVK is produced so it must be updated to the latest firmware version through the console (UART0 interface) or J-Link interface. In case of not EVB but the customized board with DA16200MOD/DA16600MOD, the deprecated firmware version is inside the modules, so there is no other options to update the firmware without the UART0 or J-Link interface due to the different OS version which can't be covered by AT command interface.

Prebuilt versions of the firmware for the DA16200 and DA16600 can be downloaded from the official website. Go to the Renesas website (<https://www.renesas.com/us/en/products/wireless-connectivity/wi-fi/low-power-wi-fi>) and scroll down to the Software Downloads section. Find or enter "DA16200 DA16600 FreeRTOS SDK Image" in the search box, and then select the firmware and download. The DA16200/DA16600 SDK can be used to rebuild the firmware images as described in Section 5.

The firmware images for the DA16200:

- DA16200\_FBOOT-GEN01-01-834dea5b8\_W25Q32JW.img
- DA16200\_FRTOS-GEN01-01-866facc56-000000.img

The firmware images for the DA16600 since it also requires the DA14531 firmware image:

- DA16600\_FBOOT-GEN01-01-834dea5b8\_AT25SL321.img
- DA16600\_FBOOT-GEN01-01-834dea5b8\_W25Q32JW.img
- DA16600\_FRTOS-GEN01-01-866facc56-000000.img
- DA14531\_P/da14531\_multi\_part\_proxr.img

**NOTE**

There are two versions of the DA16600 EVB: the Adesto AT25SL321 serial flash and the Winbond W25Q32JW serial flash.

NOTE
<p>Check the flash version by running <code>sflash info</code> command in the [MROM] prompt:</p> <pre>[/DA16600] # reset      Switch to MROM command mode. Reset BLE ... [MROM] sflash info     Display the flash information. SFLASH:ef601615 Density:01fffffff ef601615: Winbond W25Q32JWSNIQ 1f421615: Adesto AT25SL321</pre> <p>Select the appropriate firmware image based on the flash version.</p>

These firmware images are stored in the following locations in [Table 8](#).

**Table 8. Serial flash memory map**

Name	4 MB		Description
	Address	Size	
2nd Bootloader	0x0000_0000	136 kB	BOOT firmware image.
Boot Index	0x0002_2000	4 kB	Select RTOS #0 or RTOS #1 as active firmware.
RTOS #0	0x0002_3000	1788 kB	RTOS firmware image.
RTOS #1	0x001E_2000	1792 kB	Alternate RTOS firmware image. (Used during OTA firmware update)
Certificate, NVRAM	0x003A_2000	44 kB	
User Area #01	0x003A_D000	332 kB	For DA16600, the DA14531 firmware image is stored here.

NOTE
<p>On how to select which firmware image is active (RTOS #0 or RTOS #1), see Section <a href="#">4.5.4</a>.</p>

Each firmware image is downloaded individually through the debug serial port of the DA16200/DA16600 using the **Y-Modem** file transfer protocol.

### 4.5.1 Use `uart_program_da16200` in Console Terminal

This tool is a prebuilt console program which can be used in Windows, Linux, or Python environment. The tool can be found in the folders:

- `<sdk_root_directory>/utility/j-link/scripts/qspi/win/ -> uart_program_da16200.exe`
- `<sdk_root_directory>/utility/j-link/scripts/qspi/linux -> uart_program_da16200`
- `<sdk_root_directory>/utility/j-link/scripts/qspi/phython-> uart_program_da16200.py`

To program firmware images to the DA16200/DA16600, complete the following steps:

1. Copy the console program to the folder which has the images for the DA16200/DA16600.
2. Connect the EVB to the host computer using a Micro USB cable.
3. Power up the DA16200/DA16600 EVB.
4. Type `uart_program_da16200(.exe) -i <start address> <image name>` and click **Enter**.
  - a. Example for FBOOT firmware image: `uart_program_da16200.exe -i 0 DA16600_FBOOT-GEN01-01-c7f4c6cc22_AT25SL321.img`
  - b. Example for FRTOS firmware image: `uart_program_da16200.exe -i 23000 DA16600_FRTOS-GEN01-01-0561372b7c-006529.img`
  - c. Example for DA14531 firmware image: `uart_program_da16200.exe -i 3AD000 da14531_multi_part_proxr.img`

### 5. Select number from the list of COM ports and click **Enter**.

```
d:\download>uart_program_da16200.exe -i 0 DA16200_FBOOT-GEN01-01-c7f4c6cc22_W25Q32JW.img
uart_program_da16200 Version 1.0.5
0. COM75 - USB Serial Port (COM75)
1. COM76 - USB Serial Port (COM76)
Please enter a number from the list of your COM port and click Enter.
--> 0
```

Programming is done automatically so that it needs to be confirmed whether the images are programmed successfully.

### 6. Repeat steps 4~6 to program the FRTOS firmware image and the DA14531 firmware image (if using DA16600MOD) as follows.

```
d:\download>uart_program_da16200.exe -i 0 DA16200_FBOOT-GEN01-01-c7f4c6cc22_W25Q32JW.img
uart_program_da16200 Version 1.0.5
0. COM75 - USB Serial Port (COM75)
1. COM76 - USB Serial Port (COM76)
Please enter a number from the list of your COM port and click Enter.
--> 0
Selected COM port = COM75 - USB Serial Port (COM75)
Entering download mode...
Preparing for download...
Read DA16200_FBOOT-GEN01-01-c7f4c6cc22_W25Q32JW.img
Ready for download.
Download file 1: DA16200_FBOOT-GEN01-01-c7f4c6cc22_W25Q32JW.img : 100.00% : 8.12s
Done successfully.
d:\download>uart_program_da16200.exe -i 23000 DA16200_FRTOS-GEN01-01-c4ca8087e8-006537.img
uart_program_da16200 Version 1.0.5
0. COM75 - USB Serial Port (COM75)
1. COM76 - USB Serial Port (COM76)
Please enter a number from the list of your COM port and click Enter.
--> 0
Selected COM port = COM75 - USB Serial Port (COM75)
Entering download mode...
Preparing for download...
Ready for download.
Download file 1: DA16200_FRTOS-GEN01-01-c4ca8087e8-006537.img : 100.00% : 72.76s
Done successfully.
```

### 7. Confirm logs from the DA16200/DA16600 for checking the DA16200/DA16600 works properly as follows:

- a. Type `uart_program_da16200(.exe)`.
- b. Select **number** in the list of COM ports and click **Enter**.
- c. Type `reboot`.

```
d:\download>uart_program_da16200.exe
uart_program_da16200 Version 1.0.5
0. COM75 - USB Serial Port (COM75)
```

### 1. COM76 - USB Serial Port (COM76)

Please enter a number from the list of your COM port and click Enter.

--> 0

Selected COM port = COM75 - USB Serial Port (COM75)

Entering console mode...

Ready for console mode. Input anything.

```
[/DA16200] # reboot
```

```
reboot
```

Wakeup source is 0x0

```
[dpm_init_retmemory] DPM INIT CONFIGURATION(1)
```

```
*****
*           DA16200 SDK Information
* -----
*
* - CPU Type       : Cortex-M4 (120 MHz)
* - OS Type        : FreeRTOS 10.4.3
* - Serial Flash   : 4 MB
* - SDK Version    : V3.2.8.0 GEN
* - F/W Version    : FRTOS-GEN01-01-c4ca8087e8-006537
* - F/W Build Time : Jul 31 2023 14:07:09
* - Boot Index     : 0
*
*****
```

System Mode : Station Only (0)

```
>>> Start DA16X Supplicant ...
```

```
>>> DA16x Supp Ver2.7 - 2022_03
```

```
>>> MAC address (sta0) : d4:3d:39:11:34:fc
```

```
>>> sta0 interface add OK
```

```
>>> Start STA mode...
```

```
>>> Hello World #1 ( Non network dependent application ) !!!
```

### 8. Reset to factory defaults:

If it is the first time using the EVB or to delete nvram data and certificates, run the factory command.

```
[/DA16200] # factory
```

```
factory
```

```
FACTORY RESET [N/y/?] y
```

```
y
```

```
←Start Factory-Reset ...
```

```
Rebooting....
```

Wakeup source is 0x0

```
[dpm_init_retmemory] DPM INIT CONFIGURATION(1)
```

```
*****
*           DA16200 SDK Information
```

```

* -----
*
* - CPU Type      : Cortex-M4 (120 MHz)
* - OS Type      : FreeRTOS 10.4.3
* - Serial Flash  : 4 MB
* - SDK Version   : V3.2.8.0 GEN
* - F/W Version   : FRTOS-GEN01-01-c4ca8087e8-006537
* - F/W Build Time : Jul 31 2023 14:07:09
* - Boot Index    : 0
*
*
*****
System Mode : Station Only (0)
>>> Start DA16X Supplicant ...
>>> DA16x Supp Ver2.7 - 2022_03
>>> MAC address (sta0) : d4:3d:39:11:34:fc
>>> sta0 interface add OK
>>> Start STA mode...
>>> Hello World #1 ( Non network dependent application ) !!!

```

When the firmware images are programmed successfully, the device can be configured by doing the Wi-Fi provisioning process. For details on how to provision the Wi-Fi communication interface, see Section 4.6. For more information on how to use `uart_program_da16200(.exe/py)`, see `README.md` in python folder.

### 4.5.2 Use Macro Script of Tera Term

This tool is for Windows only and the programming can be done automatically using a macro script of Tera Term. These macro files are available in the `SDKROOT\apps\da16200\get_started\projects\da16200` or `da16600\img\` folder in SDK package or each image folder of image package. The serial port should be set up as shown in Figure 10. The lower numbered COM port should be selected for DA16200 debug interface.

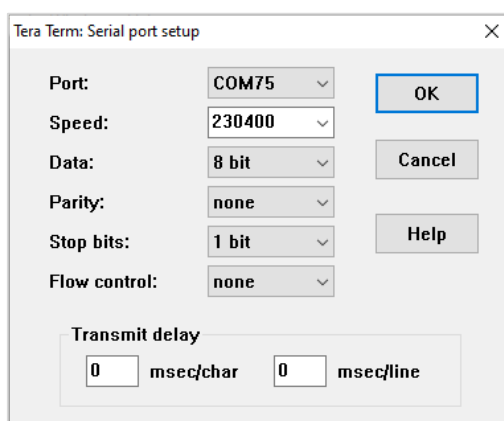

Figure 10. Serial port setup in Tera Term

The macro can be run as follows:

1. When Tera Term is connected to the DA16200/DA16600, open the **Control** tab, and select the **Macro** menu item.
2. When the **MACRO: Open Macro** file selection window opens, navigate to the directory where the firmware images are stored and select the `.ttl` file as shown in Figure 11.

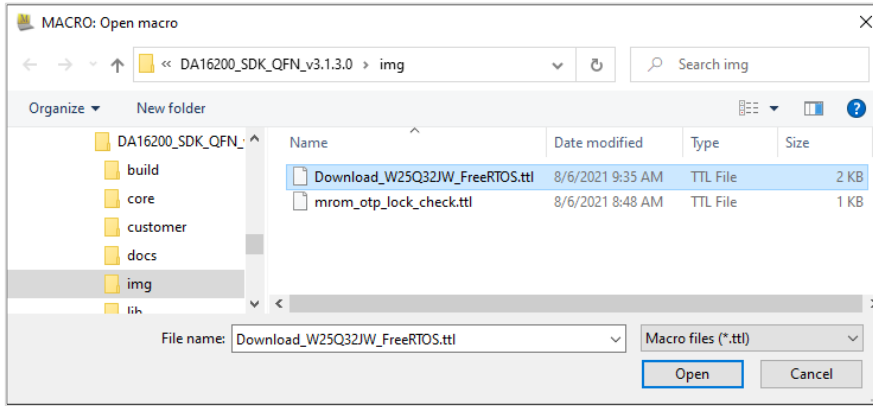

Figure 11. Open macro file

3. After opening the macro file, the FBOOT firmware image is programmed as shown in Figure 12.

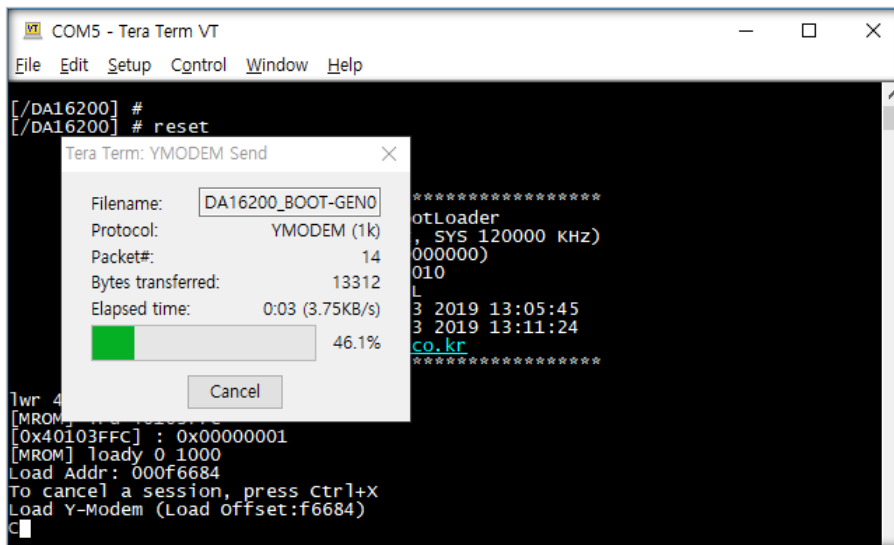

Figure 12. Programming FBOOT image

4. Program RTOS image as shown in Figure 13.



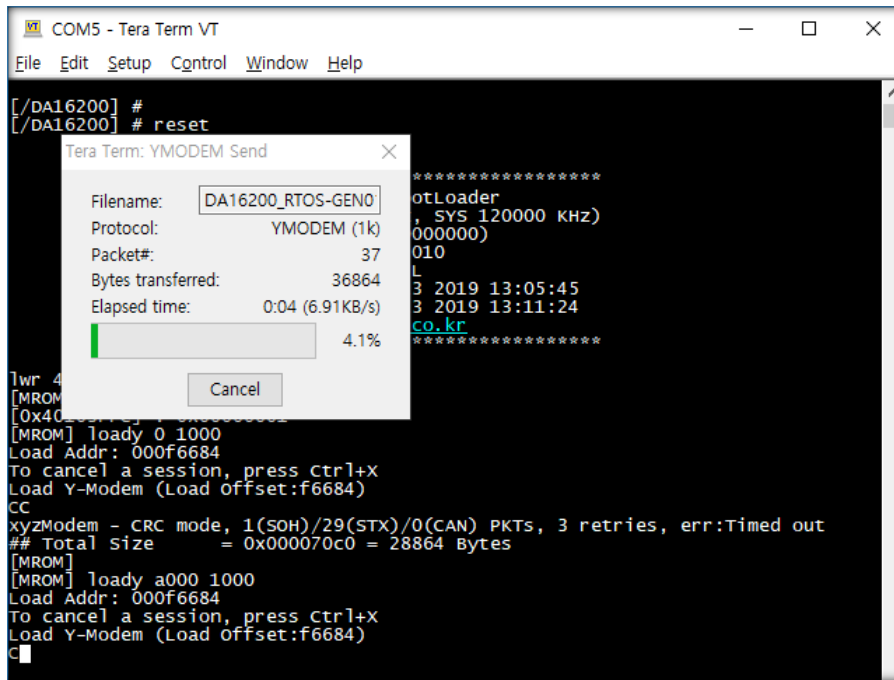

Figure 13. Programming FRTOS image

5. DA16200 reboots automatically after all images are programmed.

### 4.5.3 Use Multi-Download Tool

The Multi-Download Tool can be used to program firmware images to multiple devices at the same time in Windows. For details, see Ref. [7]. The `uart_program_da16200(.exe)` can be used for programming the firmware images to multiple devices by running the program on multiple terminals.

### 4.5.4 Change Boot Index

There are two slots, in which the main firmware image FRTOS can be stored in the SFlash memory. These locations are RTOS #0 and RTOS #1. You can specify which firmware image the board boots up with through the serial interface after booting up or MROM prompt in UART console.

#### 4.5.4.1 Changing Boot Index after Bootup

The **boot index** can be changed by using the `boot_idx n` command:

- `boot_idx 0` // set RTOS #0 as the firmware to boot
- `boot_idx 1` // set RTOS #1 as the firmware to boot

After running the `boot_idx` command, run the `reboot` command to boot the selected firmware.

```
[/DA16200] # boot_idx 1 // or boot_idx 0
[/DA16200] # reboot
>>> P.TIM is relocated to RETMEM (0x20f835c0, 3)
[dpm_init_retmemory] DPM INIT CONFIGURATION(1)
Wakeup source is 0x0
*****
*           DA16200 SDK Information
*
* - CPU Type       : Cortex-M4 (120 MHz)
* - OS Type        : FreeRTOS 10.4.3
* - Serial Flash   : 4 MB
```

```

* - SDK Version      : V3.2.3.0 GEN
* - F/W Version      : FRTOS-GEN01-01-6cc84b86f-003714
* - F/W Build Time   : Apr 13 2022 10:20:02
* - Boot Index       : 1
*
*****
    
```

After rebooting, verify the **Boot Index** and **F/W Version** match the selected one.

**4.5.4.2 Changing Boot Index in MROM Prompt**

The **boot index** can be changed by `sflash erase` and `write` command in MROM prompt. Do the following:

1. Go to MROM prompt using `[/DA16200] # reset.`
2. To change the boot index to 0 (RTOS #0), erase the boot index area, it is already in the `ttl` download script.

```

[MROM] sflash erase 22000 1000
[MROM] reboot
    
```

3. To write the boot index to 1 (RTOS #1), it should erase and write some values, which means 0x1E2000 with header.

Ensure there is the RTOS #1 image in the flash address 0x1E2000, otherwise it won't be booted up correctly.

```

[MROM] sflash erase 22000 1000
[MROM] sflash write 22000 C AF BE AD DE 01 00 00 00 00 20 1E 00
[MROM] reboot
    
```

**4.5.5 GPIOs for Pre-built Images**

The prebuilt versions of the firmware for the DA16200 and DA16600 mentioned in Section 4.5.

Dedicated UART0 and buttons for all pre-built images:

- UART0\_TXD (debug console)
- UART0\_RXD (debug console)
- GPIOA6 (WPS button)
- GPIOA7 (Factory reset button)

AT command interface for each image is listed up in [Table 9](#).

**Table 9. Firmware images vs GPIOs**

Firmware image	GPIO PINS
DA16200_IMG_FreeRTOS_ATCMD_SPI_EVK	GPIOA2 (SPI_CSB) GPIOA3 (SPI_CLK) GPIOA8 (SPI_MISO) GPIOA9 (SPI_MOSI) GPIOC6 (INT) GPIOA11 (MCU Wake-up)
DA16200_IMG_FreeRTOS_ATCMD_SPI_SPARKFUN	GPIOA0 (SPI_MISO) GPIOA1 (SPI_MOSI) GPIOA2 (SPI_CSB) GPIOA3 (SPI_CLK) GPIOC10 (INT) GPIOA11 (MCU Wake-up)
DA16200_IMG_FreeRTOS_ATCMD_UART1_EVK	GPIOA4 (UART1_TXD) GPIOA5 (UART1_RXD) GPIOA11 (MCU Wake-up)

Firmware image	GPIO PINS
DA16200_IMG_FreeRTOS_QFN	No AT command interface
DA16600_IMG_FreeRTOS_ATCMD_SPI_EVK	GPIOA2 (SPI_CSB) GPIOA3 (SPI_CLK) GPIOA8 (SPI_MISO) GPIOA9 (SPI_MOSI) GPIOC6 (INT) GPIOA11 (MCU Wake-up)
DA16600_IMG_FreeRTOS_ATCMD_UART2_EVK	GPIOC6 (UART2_TXD) GPIOC7 (UART2_RXD) GPIOA11 (MCU Wake-up)
DA16600_IMG_FreeRTOS_QFN	No AT command interface

## 4.6 Wi-Fi Provisioning

### 4.6.1 Station Mode Setup

The Wi-Fi functions of the DA16200/DA16600 can easily be configured by running the **Easy Setup** Wi-Fi configuration wizard.

To configure the DA16200/DA16600 to operate in Station Mode, open the DA16200 or DA16600 debug console and run the `setup` command in the `[/DA16xxx]` prompt and then answer the questions to complete the setup as follows:

```

[/DA16200] Setup                               Start the Easy Setup Wizard.
Stop all services for the setting.
Are you sure ? [Yes/No] : Y                    Enter Y to stop the services.
[ DA16200 EASY SETUP ]
Country Code List:
AD AE AF AI AL AM AR AS AT AU AW AZ BA BB BD BE BF BG BH BL
BM BN BO BR BS BT BY BZ CA CF CH CI CL CN CO CR CU CX CY CZ
DE DK DM DO DZ EC EE EG ES ET EU FI FM FR GA GB GD GE GF GH
GL GP GR GT GU GY HK HN HR HT HU ID IE IL IN IR IS IT JM JO
JP KE KH KN KP KR KW KY KZ LB LC LI LK LS LT LU LV MA MC MD
ME MF MH MK MN MO MP MQ MR MT MU MV MW MX MY NG NI NL NO NP
NZ OM PA PE PF PG PH PK PL PM PR PT PW PY QA RE RO RS RU RW
SA SE SG SI SK SN SR SV SY TC TD TG TH TN TR TT TW TZ UA UG
UK US UY UZ VA VC VE VI VN VU WF WS YE YT ZA ZW ALL
COUNTRY CODE ? [Quit] (Default KR) : US      Enter the country code.
SYSMODE (WLAN MODE) ?
    1. Station
    2. Soft AP
MODE ? [1/2/Quit] (Default Station) : 1      Enter 1 for Station mode.
[ STATION CONFIGURATION ]
-----
[NO] [SSID]                                [SIGNAL] [CH] [SECURITY]
-----
[ 1] AndroidHotspot0568                    -25  6      WPA2
    
```

```
[ 2] U+Net0208                -37  2      WPA2
[ 3] wonhome                  -49 11      WPA2
[ 4] SK_WiFiGIGA1200         -53  3  WPA / WPA2
[ 5] [Hidden] BSSID-0a:5d:dd:de:12:03 -54  3      WPA2
[ 6] DIRECT-GWM2020 Series   -56  3      WPA2
[ 7] AT_303_WBEH2GT_a879    -66 11      WPA2
[ 8] olleh_WiFi_B602        -67 10  WPA / WPA2
[ 9] KT_GiGA_2G_Wave2_04A0   -70  6  WPA / WPA2
[10] KT_GiGA_2G_Wave2_99EB   -79  6  WPA / WPA2
[11] anyppi                  -81  8      WPA2

-----

[M] Manual Input
[Enter] Rescan

=====

Select SSID ? (1~11/Manual/Quit) : 1          Enter the SSID NO from the list.
PSK-KEY(ASCII characters 8~63 or Hexadecimal characters 64) ? [Quit]
[123456789|123456789|123456789|123456789|123456789|123456789|1234]
:*****          Enter the password for the AP.
Do you want to set advanced WiFi configuration ? [No/Yes/Quit] (Default No) : N
          Enter N to skip this step.

=====

SSID      : AndroidHotspot0568
AUTH      : WPA/WAP2
ENCRYPTION: TKIP/AES (CCMP)
PSK KEY   : 123abc456
KEY TYPE  : ASCII
Hidden AP : Not connect
WIFI CONFIGURATION CONFIRM ? [Yes/No/Quit] : Y          Enter Y to confirm the configuration.
IP Connection Type ? [Automatic IP/Static IP/Quit] : A    Enter A for automatic DHCP IP address.
IP Connection Type: Automatic IP
IP CONFIGURATION CONFIRM ? [Yes/No/Quit] : Y          Enter Y to confirm the configuration.

SNTP Client enable ? [Yes/No/Quit] : N          Enter N to disable time sync.
Dialog DPM (Dynamic Power Management) ? [Yes/No/Quit] : N    Enter N to disable DPM.
          See Section 6.4.7 for more information about DPM.

Configuration OK
. done
```

The configuration is now complete and stored in NVRAM. Then, the system reboots automatically and is connected to the selected network.

```
Reboot...
Wakeup source is 0x0
[dxm_init_retmemory] DPM INIT CONFIGURATION(1)
```

```

*****
*           DA16200 SDK Information
* -----
*
* - CPU Type       : Cortex-M4 (120 MHz)
* - OS Type        : FreeRTOS 10.4.3
* - Serial Flash   : 4 MB
* - SDK Version    : V3.2.3.0 GEN
* - F/W Version    : FRTOS-GEN01-01-6cc84b86f-003714
* - F/W Build Time : Apr 13 2022 10:20:02
* - Boot Index     : 0
*
*****

System Mode : Station Only (0)
>>> DA16x Supp Ver2.7 - 2020_07
>>> MAC address (sta0) : d4:3d:39:10:a2:48
>>> sta0 interface add OK
>>> Start STA mode...
>>> Network Interface (wlan0) : UP
>>> Associated with ae:2d:be:27:70:7d
Connection COMPLETE to ae:2d:be:27:70:7d
-- DHCP Client WLAN0: SEL(6)
[/DA16200] # -- DHCP Client WLAN0: REQ(1)
-- DHCP Client WLAN0: CHK(8)
-- DHCP Client WLAN0: BOUND(10)
    Assigned addr   : 192.168.0.65
        netmask     : 255.255.255.0
        gateway     : 192.168.0.98
        DNS addr    : 192.168.0.98
    DHCP Server IP  : 192.168.0.98
    Lease Time      : 00h 59m 59s
    Renewal Time    : 00h 29m 59s

```

### 4.6.2 Soft AP Mode Setup

Soft AP mode allows the DA16200 to be provisioned through the Wi-Fi interface using a mobile application. Set up for Soft AP Mode is almost the same as for Station Mode and can easily be configured by running the **Easy Setup** Wi-Fi configuration wizard.

To configure the DA16200/DA16600 to operate in Soft AP mode, open the DA16200/DA16600 debug console and run the `setup` command in the `[DA16200]` or `[DA16600]` prompt and then answer the questions to complete the setup as follows:

```

[/DA16200] Setup                               Start the Easy Setup Wizard.

Stop all services for the setting.

Are you sure ? [Yes/No] : Y                     Enter Y to stop the running services.

```

```
[ DA16200 EASY SETUP ]
Country Code List:
AD AE AF AI AL AM AR AS AT AU AW AZ BA BB BD BE BF BG BH BL
BM BN BO BR BS BT BY BZ CA CF CH CI CL CN CO CR CU CX CY CZ
DE DK DM DO DZ EC EE EG ES ET EU FI FM FR GA GB GD GE GF GH
GL GP GR GT GU GY HK HN HR HT HU ID IE IL IN IR IS IT JM JO
JP KE KH KN KP KR KW KY KZ LB LC LI LK LS LT LU LV MA MC MD
ME MF MH MK MN MO MP MQ MR MT MU MV MW MX MY NG NI NL NO NP
NZ OM PA PE PF PG PH PK PL PM PR PT PW PY QA RE RO RS RU RW
SA SE SG SI SK SN SR SV SY TC TD TG TH TN TR TT TW TZ UA UG
UK US UY UZ VA VC VE VI VN VU WF WS YE YT ZA ZW ALL

COUNTRY CODE ? [Quit] (Default KR) : US          Enter the country code.
SYSMODE(WLAN MODE) ?
    1. Station
    2. Soft AP
MODE ? [1/2/Quit] (Default Station) : 2          Enter 2 for Station mode.
[ SOFT AP CONFIGURATION ]
SSID ? (Default DA16200_10A249) : TEST AP        Enter the SSID name.
CHANNEL ? [1~13, Auto:0/Quit] (Default Auto) :   Enter to select Auto channel selection.
AUTHENTICATION ?
    1. OPEN
    2. WEP(Unsupported)
    3. WPA-PSK
    4. WPA2-PSK (Recommend)
    5. WPA/WPA2-PSK
AUTHENTICATION ? [1/3/4/5/Quit] : 4            Enter 4 to select WPA2-PSK authentication.
ENCRYPTION ?
    1. TKIP (CAUTION: Unsupported 802.11N Mode)
    2. AES (CCMP)
    3. TKIP/AES (CCMP)
ENCRYPTION ? [1/2/3/Quit] : 2                  Enter 2 to select AES encryption.
PSK-KEY(ASCII characters 8~63 or Hexadecimal characters 64) ? [Quit]
[123456789|123456789|123456789|123456789|123456789|123456789|1234]
:*****                                       Enter the password for the AP.
Do you want to set advanced WiFi configuration ? [No/Yes/Quit] (Default No) : N
                                           Enter N to skip this step.

=====
SSID      : TEST AP
CHANNEL   : AUTO (ACS)
AUTH      : WPA2
ENCRYPTION: AES (CCMP)
PSK KEY   : 123abc456
```

```

KEY TYPE : ASCII
WIFI MODE : 11b/g/n

=====
WIFI CONFIGURATION CONFIRM ? [Yes/No/Quit] : Y      Enter Y to confirm the WIFI
                                                    configuration.
IP ADDRESS ? [Quit] (Default 10.0.0.1) :           Enter to select the default IP Address.
SUBNET ? [Quit] (Default 255.255.255.0) :         Enter to select the default Subnet.
GATEWAY ? [Quit] (Default 10.0.0.1) :             Enter to select the default Gateway.

=====

[WLAN1]
IP ADDRESS: 10.0.0.1
SUBNET : 255.255.255.0
GATEWAY : 10.0.0.1

=====
IP CONFIGURATION CONFIRM ? [Yes/No/Quit] : Y      Enter Y to confirm the IP configuration.
DHCP SERVER CONFIGURATION ? [Yes/No/Quit] : Y      Enter Y to confirm the DHCP Server
                                                    configuration.
DHCP SERVER LEASE IP Count (MAX 10) ? [Quit] (Default 10) :
                                                    Enter to select the default Lease Count.
DHCP SERVER LEASE TIME (60 ~ 86400 SEC) ? [Quit] (Default 1800) :
                                                    Enter to select the default Lease Time.

=====

[DHCP SERVER]
Start IP : 10.0.0.2
END IP : 10.0.0.11
LEASE TIME: 1800

=====
DHCP SERVER CONFIGURATION CONFIRM ? [Yes/No/Quit] : Y      Enter Y to confirm the configuration.
Configuration OK
. done
    
```

When all settings are configured, the configuration is saved, and the system reboots. Then, a message appears that Soft AP mode started successfully:

```

Reboot...
Wakeup source is 0x0
[dpm_init_retmemory] DPM INIT CONFIGURATION(1)
*****
*           DA16200 SDK Information
* -----
*
* - CPU Type      : Cortex-M4 (120 MHz)
* - OS Type       : FreeRTOS 10.4.3
* - Serial Flash  : 4 MB
    
```



```

* - SDK Version      : V3.1.3.0 GEN
* - F/W Version      : FRTOS-GEN01-01-15129-000000
* - F/W Build Time   : Aug 26 2021 22:58:01
* - Boot Index       : 0
*
*****
System Mode : Soft AP (1)
>>> DHCP Server Started
>>> DA16x Supp Ver2.7 - 2020_07
>>> Add Soft AP Inteface (softap1) ...
>>> MAC address (softap1) : d4:3d:39:10:a2:49
>>> softap1 interface add OK
>>> AP Operating Channel: AUTO
>>> Soft AP ACS : ideal ch is 4
>>> Network Interface (wlan1) : UP
BSS Isolate Disabled
Soft AP is Ready (d4:3d:39:10:a2:49)
[/DA16200] #
    
```

After Soft AP mode is configured, a mobile application can be used to remotely provision the Wi-Fi interface to operate in Station mode. For details on how to use the mobile application, see Ref. [8].

### 4.6.3 Wi-Fi Provisioning Setup Using Bluetooth® LE

Bluetooth® LE is available on DA16600 module only. The DA16600 module can be used in products such as "Wi-Fi door-lock" where Wi-Fi is the main connection used during normal operation. Bluetooth® LE is a support connection used to perform Wi-Fi Provisioning during the initial "Out-of-the-Box" setup of the product.

A Bluetooth® LE peer application such as an Android/iOS mobile application provides an interface to provision the Wi-Fi interface of the DA16600 device by providing configuration information such as a Wi-Fi Home router's SSID, password, and server information.

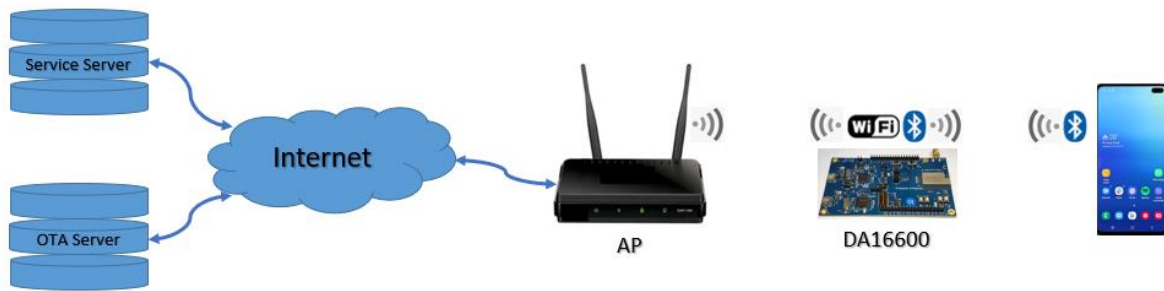

Figure 14. Diagram of provisioning through Bluetooth® LE

For details on how to use the mobile application to provision the Wi-Fi connection on the DA16600, see Ref. [6].

### 4.7 Configuring UART/SPI as AT Command Interface

This section describes how to configure the DA16200 or DA16600 EVB for testing AT commands. The DA16200 supports AT commands through UART or SPI. For more information on AT commands, see Ref. [5].

Various prebuilt AT command firmware images can be downloaded from the Renesas Electronics website. Go to the Renesas website (<https://www.renesas.com/us/en/products/wireless-connectivity/wi-fi/low-power-wi-fi>) and scroll down to the Software Downloads section. Find "DA16200 DA16600 FreeRTOS SDK Image" or type it in

the search box, and then select the firmware and download. Select DA16200\_IMG\_FreeRTOS\_ATCMD\_QFN or DA16600\_IMG\_FreeRTOS\_ATCMD\_QFN for your device.

Table 10 shows the default GPIO pin settings of the UART and SPI interfaces of the DA16200 SDK and DA16600 SDK. These GPIOs need to be connected to the MCU.

Table 10. Default GPIO pin settings of UART and SPI

Interface	DA16200 SDK	DA16600 SDK
UART	GPIOA4 (UART1_TXD) GPIOA5 (UART1_RXD)	GPIOC6 (UART2_TXD) GPIOC7 (UART2_RXD)
SPI		GPIOA2 (SPI_CS#) GPIOA3 (SPI_CLK) GPIOA8 (SPI_MISO) GPIOA9 (SPI_MOSI) GPIOC6 (INT)
MCU Wake-up on AT Command		GPIOA11 (MCU Wake-up)

### 4.7.1 Configuration for Testing AT Command with EVB Only

Both the DA16200 and DA16600 EVBs include an FT232H which is used to test AT command over the UART interface. Figure 15 and Table 11 show how to configure the DA16200 EVB for AT command processing over the UART. This configuration connects UART1 of the DA16200 (GPIOA4/5) to the FT232H.

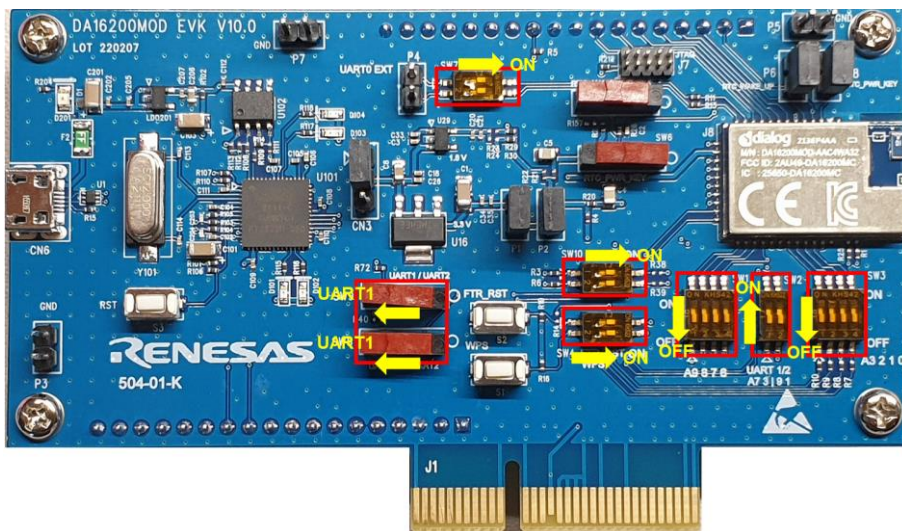

Figure 15. Configure DA16200 EVB for AT command – UART to FT232H

Table 11. Configure DA16200 EVB switch for AT command – UART to FT232H

SW1	SW2	SW3	SW4	SW7	SW8	SW9	SW10
All OFF	All ON	All OFF	All ON	All ON	LEFT	LEFT	All ON

Figure 16 and Table 12 show how to configure the DA16600 EVB for AT command processing over the UART. This configuration connects UART2 of the DA16600 (GPIOC6/7) to the FT232H.

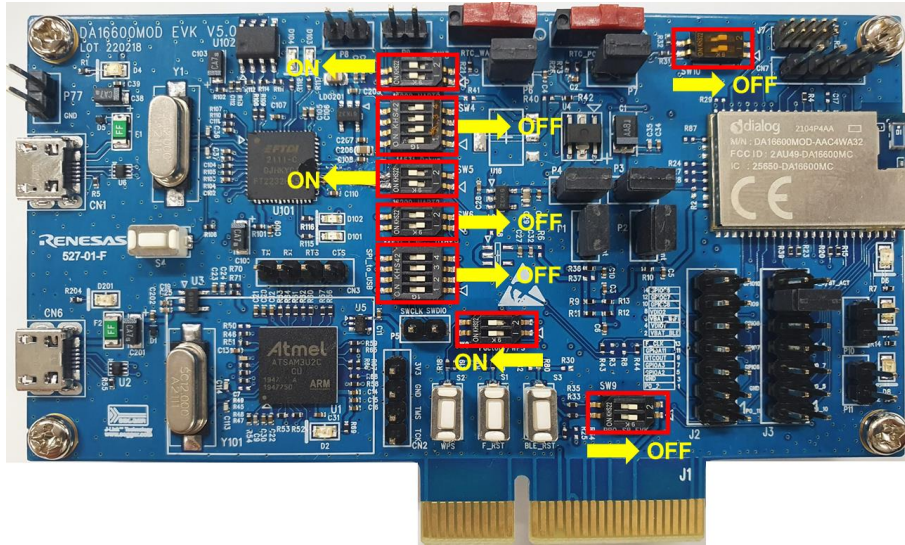

Figure 16. Configure DA16600 EVB for AT command – UART to FT232H

Table 12. DA16600 EVB switch configuration for AT command – UART to FT232H

SW3	SW4	SW5	SW6	SW7	SW8	SW9	SW10
All ON	All OFF	All ON	All OFF	All OFF	All ON	All OFF	All OFF

For further steps, see Ref. [5].

#### 4.7.2 Configuration for Testing AT Command with External MCU

Both the DA16200 and DA16600 EVBs have external pins which allow you to test AT command over the UART or SPI interface using an external MCU.

Figure 17, Table 13, and Table 14 show how to configure the DA16200 EVB for AT command processing over the UART or SPI interface using an external MCU. This configuration connects UART1 or SPI of the DA16200 (GPIOA4/5 for UART or GPIOA2/3/8/9 for SPI) to the external pinout connectors.

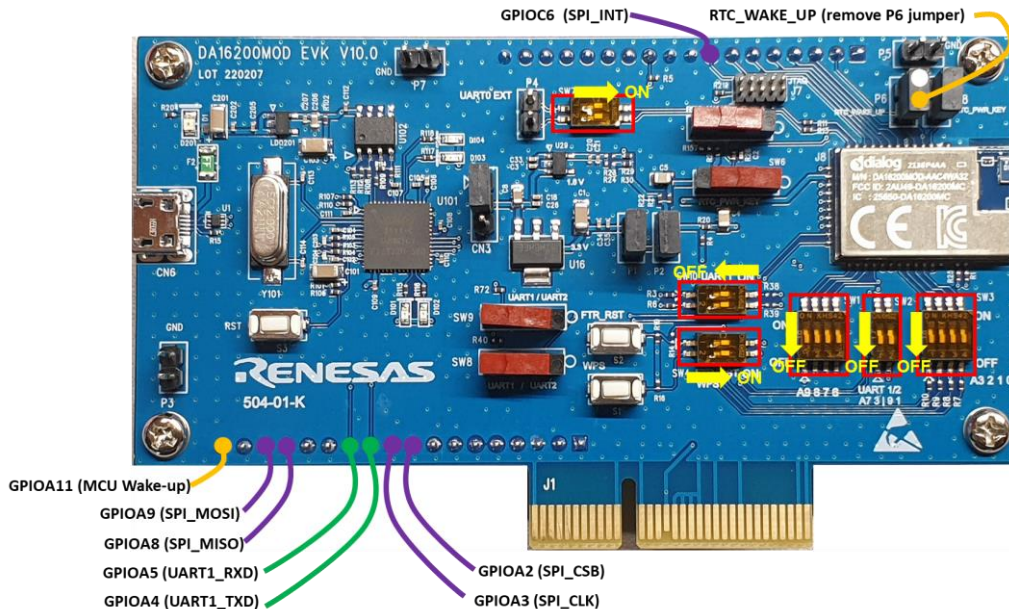

Figure 17. Configure DA16200 EVB for AT command – UART/SPI to external MCU

Table 13. Configure DA16200 EVB switch for AT command – UART/SPI with external MCU

SW1	SW2	SW3	SW4	SW7	SW8	SW9	SW10
All OFF	All OFF	All OFF	All ON	All ON	Don't care	Don't care	All OFF



Table 14. Configure DA16200 EVB connector for AT command – UART/SPI with external MCU

Interface	Connector	Pin	Relevant GPIO	Usage
AT Command over UART	P6	1	RTC_WAKE_UP	DA16200 Wake-up from MCU
	J5	11	GPIOA4	UART1_TXD
		12	GPIOA5	UART1_RXD
		18	GPIOA11	MCU Wake-up from DA16200
AT Command over SPI	P6	1	RTC_WAKE_UP	DA16200 Wake-up from MCU
	J2	8	GPIOC6	SPI_INT
	J5	9	GPIOA2	SPI_CSB
		10	GPIOA3	SPI_CLK
		15	GPIOA8	SPI_MISO
		16	GPIOA9	SPI_MOSI
	18	GPIOA11	MCU Wake-up from DA16200	

Figure 18, Table 15. and Table 16 show how to configure the DA16600 EVB for AT commands over the UART or SPI interface using an external MCU. This configuration connects UART2 or SPI of the DA16600 (GPIOC6/7 for UART or GPIOA2/3/8/9 for SPI) to the external pinout connectors.

When using an AT command over UART, Pin 11 of J3 and Pin 12 of J3 should be connected by a jumper pin for Wi-Fi and Bluetooth® LE coexistence. In addition, when using an AT command over SPI, Pin 13 of J3 and Pin 14 of J3 should be connected.

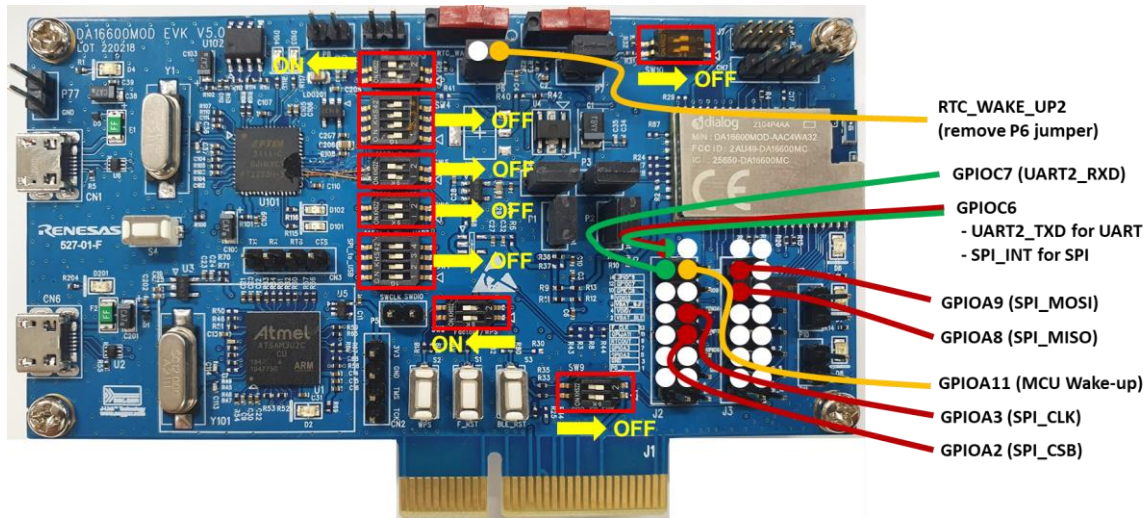

Figure 18. Configure DA16600 EVB for AT command – UART/SPI with external MCU

Table 15. Configure DA16600 EVB switch for AT command – UART/SPI with external MCU

SW3	SW4	SW5	SW6	SW7	SW8	SW9	SW10
All ON	All OFF	All OFF	All OFF	All OFF	All ON	All OFF	All OFF

Table 16. Configure DA16600 EVB connector for AT command – UART/SPI with external MCU

Interface	Connector	Pin	Relevant GPIO	Usage
AT Command over UART	P6	1	RTC_WAKE_UP2	DA16200 Wake-up from MCU
	J2	11	GPIOA11	MCU Wake-up from DA16200
		12	GPIOC7	UART2_RXD
		14	GPIOC6	UART2_TXD
Pin 11 (P0_6) and Pin 12 (GPIOA9) should be connected.				

Interface	Connector	Pin	Relevant GPIO	Usage
AT Command over SPI	P6	1	RTC_WAKE_UP2	DA16200 Wake-up from MCU
	J2	5	GPIOA2	SPI_CSB
		7	GPIOA3	SPI_CLK
		11	GPIOA11	MCU Wake-up from DA16200
		14	GPIOC6	SPI_INT
		Pin 13 (P0_6) and Pin 14 (GPIOA10) should be connected.		
	J3	10	GPIOA8	SPI_MISO
		12	GPIOA9	SPI_MOSI

## 5. Software Development Kit

### 5.1 Introduction

Wi-Fi applications can be developed for the DA16200 using the DA16200 FreeRTOS Software Development Kit (SDK) and the Renesas e<sup>2</sup> studio IDE on either a Windows 10 or Linux based development system.

To start developing applications for the DA16200, complete the following steps:

1. Install and configure the e<sup>2</sup> studio IDE.
2. Import the DA16200 SDK into the e<sup>2</sup> studio IDE and build an application.
3. Download and test the application.
4. Use J-Link debugger to debug the application.

### 5.2 System Requirements

- OS (Windows 10 64 bit or Ubuntu 20.04 LTS)
- GNU Arm<sup>®</sup> GCC 10.3
- Renesas e<sup>2</sup> studio 2023-07 (23.7.0) or later
- J-Link Debug Probe

#### NOTE

##### For Linux OS

Install mandatory library for executing e<sup>2</sup> studio – libpython3.10. Aand then open a terminal window and enter the commands:

- `sudo add-apt-repository ppa:deadsnakes/ppa`
- `sudo apt-get update`
- `sudo apt-get install libpython3.10`

### 5.3 Install e<sup>2</sup> studio IDE

To install the e<sup>2</sup> studio:

1. Download and run the e<sup>2</sup> studio installer for either Windows or Linux from the Renesas website (<https://www.renesas.com/en/software-tool/e-studio>).

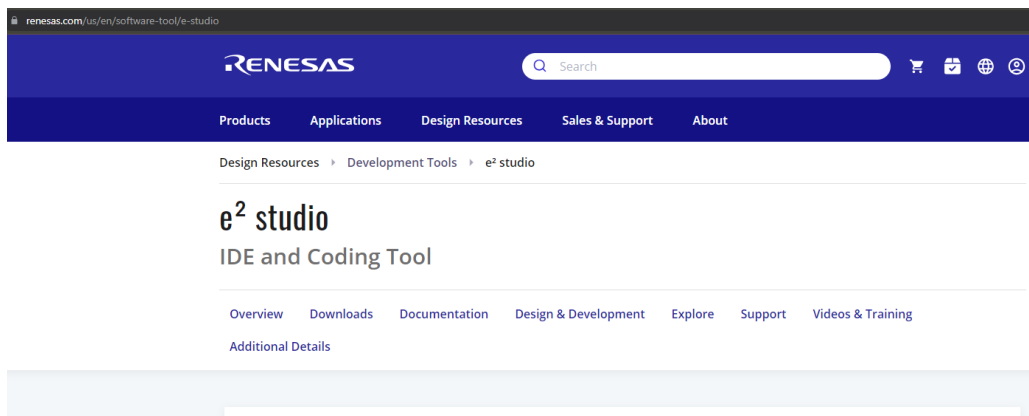

Figure 19. Download e<sup>2</sup> studio installer

#### NOTE

Currently only Windows and Linux are verified to work with the DA16200/DA16600 SDKs.

2. After running the installer, select **Standard Install**, and then click **Next**.

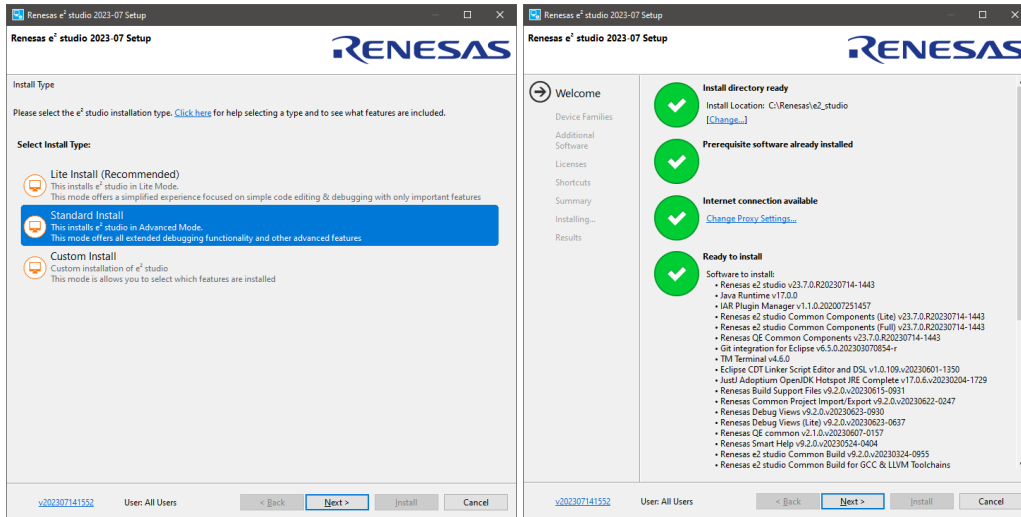

Figure 20. Run e² studio installer

**NOTE**

The e² studio Installer automatically installs the required JRE and embedded development extensions required by the DA16200/DA16600 FreeRTOS SDK.

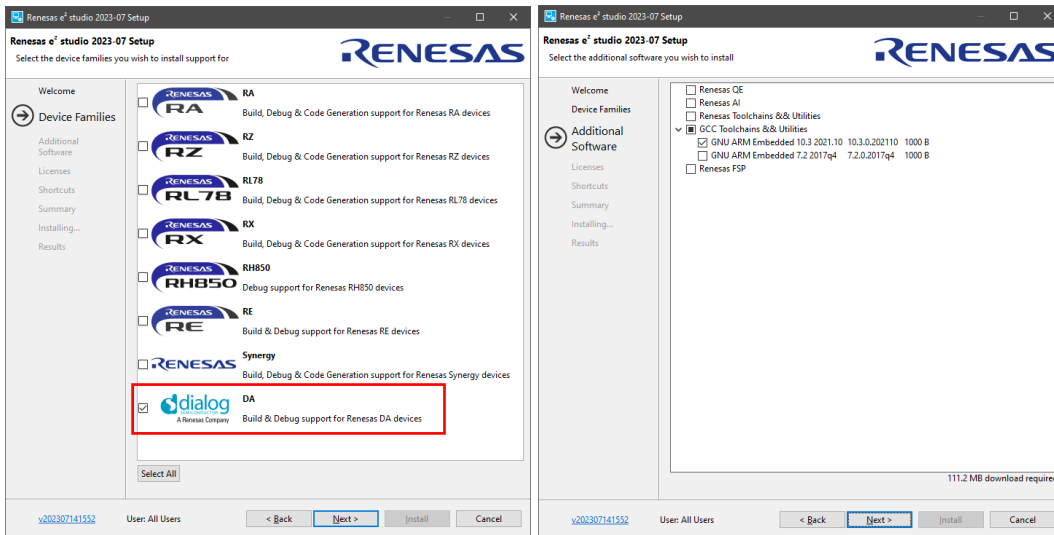

Figure 21. e² studio setup

3. Select the DA family in Device Families. The GCC toolchain is selected by default as GNU ARM® Embedded 10.3 2021.10. Then click **Next**.



Figure 22. Installing GNU Arm® Embedded Toolchain

4. Install the GNU Arm® Embedded Toolchain 10.3. The Toolchain installation starts automatically during the e<sup>2</sup> studio installation process.
5. After installing the e<sup>2</sup> studio and the GNU Arm® Embedded Toolchain, run e<sup>2</sup> studio and open the workspace.

### 5.4 Import DA16200 FreeRTOS SDK Project into e<sup>2</sup> studio

Download the DA16200 FreeRTOS SDK from the official website. Go to the Renesas website (<https://www.renesas.com/us/en/products/wireless-connectivity/wi-fi/low-power-wi-fi>) and scroll down to the Software Downloads section. Find "DA16200 DA16600 FreeRTOS SDK" or type it in the search box, and then select and download the firmware.

To import the da16200/da16600 project into the e<sup>2</sup> studio workspace, complete the following steps.

1. Under the **File** menu select **Import** to open the Import dialog box and then select **General > Dialog SDK Project** and click **Next**.

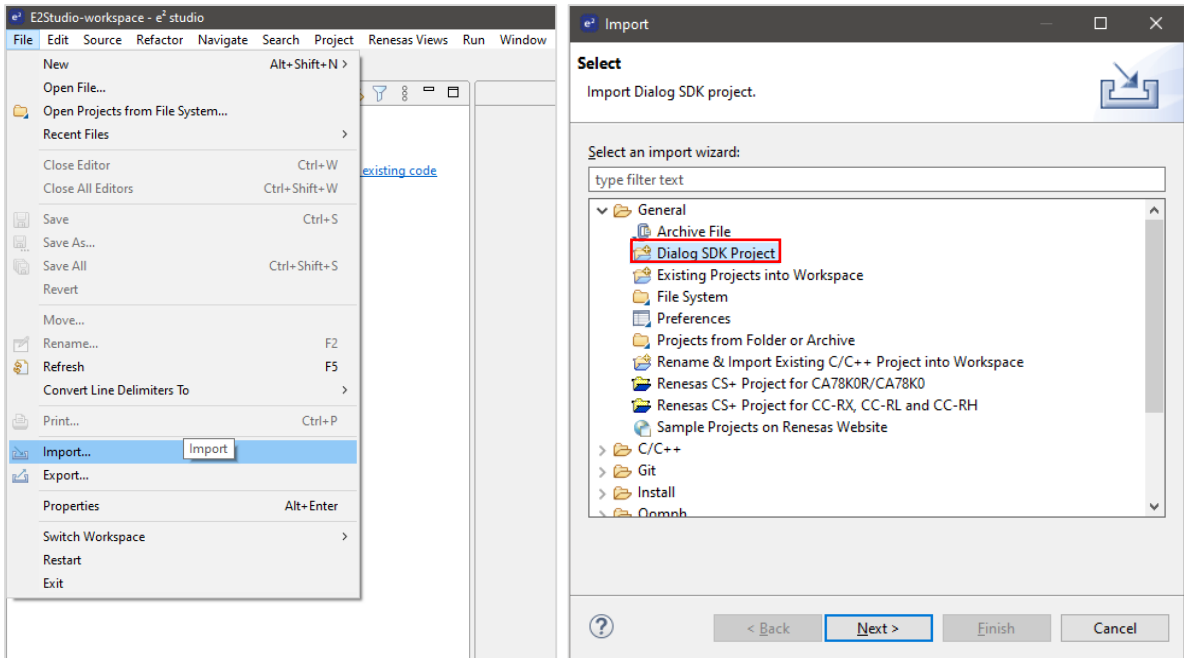

Figure 23. Import SDK project to e<sup>2</sup> studio IDE

**NOTE**

Windows 10 has a path length limitation of 260 characters. The <sdk\_root\_directory> path length must be less than 70 characters.



**NOTE**  
 In case of e<sup>2</sup> studio version released in 2025 April or later, if there is a project imported as the Dialog SDK project, select **Existing Projects into Workspace**.

- In the **Import Projects** dialog, select the **Select SDK root directory** and click the **Browse** button. Use the file manager to navigate to the <sdk\_root\_directory>/ directory and then click **Select Folder**.

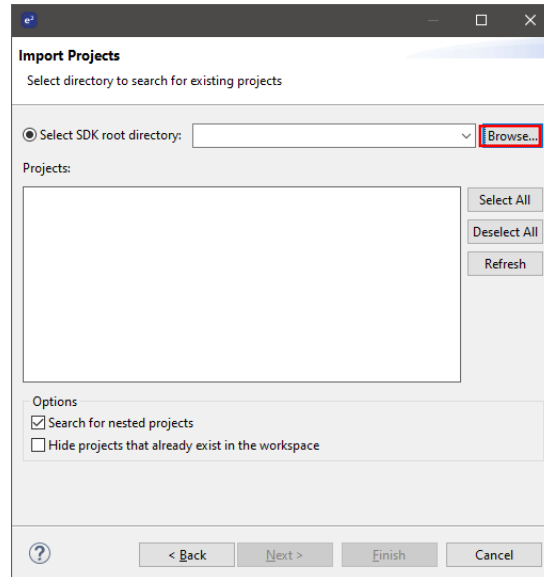

Figure 24. Import project

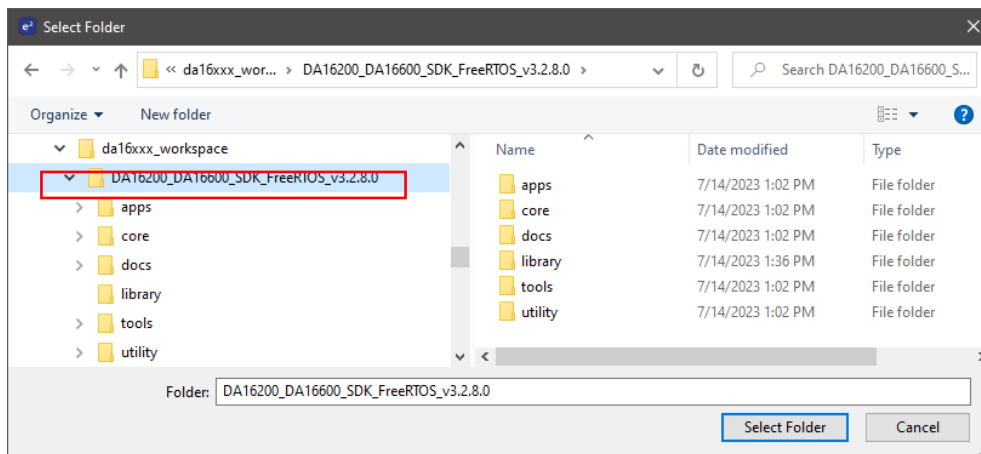

Figure 25. Select folder to import SDK project into e<sup>2</sup> studio IDE

- Among various projects in the **Projects** list, select the **da16200** or **da16600** project. The second project to select is the **SDKJFlash** project which provides an absolute path for certain scripts to use and click **Next**.

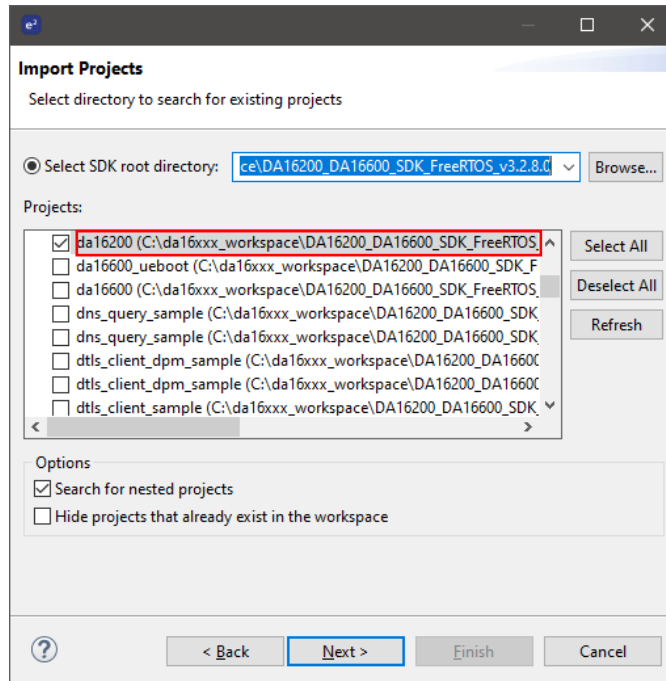

Figure 26. Import DA16200/DA16600 project to e<sup>2</sup> studio IDE

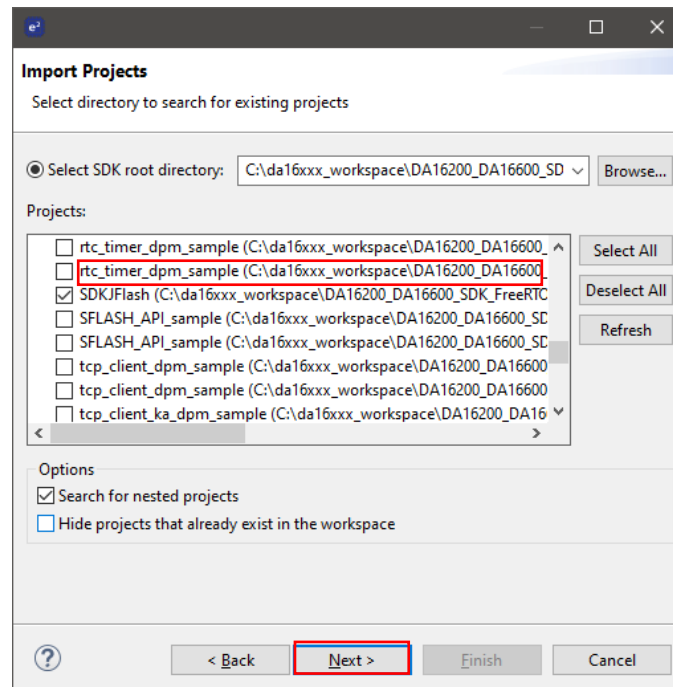



Figure 27. Import SDKJFlash project to e<sup>2</sup> studio IDE

- The **Dialog SDK Project** appears as shown in [Figure 28](#). Select Target device da16200 or da16600 by choosing the  button and then click **Finish**.

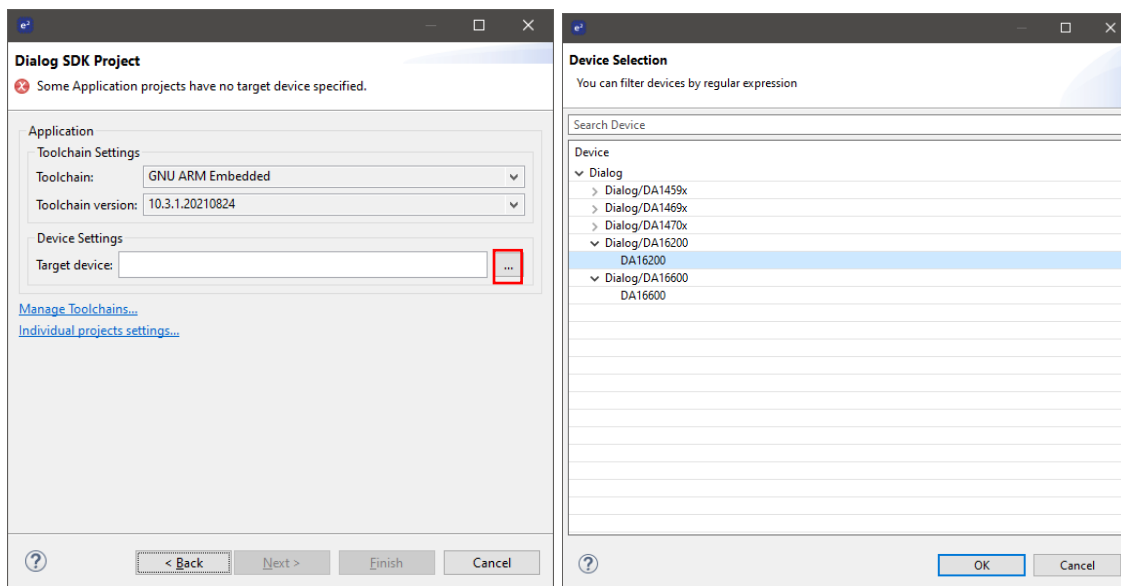

Figure 28. Dialog SDK project

The basic setup for importing the SDK project is now complete. The next step is to build the project.

Here are some examples before importing projects.

- Create a workspace directory for the SDK. For example:  
`..../projects/dal6xxx_workspace`
- Extract the SDK zip file into a directory under that workspace directory. For example:  
`..../projects/dal6xxx_workspace/DA16200_DA16600_SDK_V3.2.x.x`  
 This directory is known as the `<sdk_root_directory>`.
- Run e<sup>2</sup> studio and open the newly created workspace.

**NOTE**

For Linux systems, certain files used during the build process need to be set as executable. After extracting the SDK files into a directory, the `<sdk_root_directory>/tools/util` file permissions must be changed by running the `set_linux_perm.sh` script in the `<sdk_root_directory>/tools/util/` directory:

```
~$
~$ cd <sdk_root_directory>/tools/util
~$ chmod 755 set_linux_perm.sh
~$ sh ./set_linux_perm.sh
~$
```

The SDK directory structure contains various projects, and projects are stored in the `<sdk_root_directory>/apps/` directory. These include the following:

- Default SDK build for the DA16200 and DA16600
  - `<sdk_root_directory>/apps/dal6200/get_started/`
  - `<sdk_root_directory>/apps/dal6600/get_started/`
- Example projects
  - `<sdk_root_directory>/apps/common/examples/Crypto/`
  - `<sdk_root_directory>/apps/common/examples/DPM/`
  - `<sdk_root_directory>/apps/common/examples/ETC/`
  - `<sdk_root_directory>/apps/common/examples/Network/`
  - `<sdk_root_directory>/apps/common/examples/Periphial/`

The example project directories have a similar structure, containing a project folder for either the DA16200 or DA16600:

- `<sdk_root_directory>/apps/common/examples/Crypto/Crypto_AES/projects/dal6200`

- <sdk\_root\_directory>/apps/common/examples/Crypto/Crypto\_AES/projects/da16600

## 5.5 Build Projects

1. When the target projects are imported, it appears in the e<sup>2</sup> studio Project Explorer. Build the da16200/da16600project by right-clicking on the imported project and select **Build Project**.

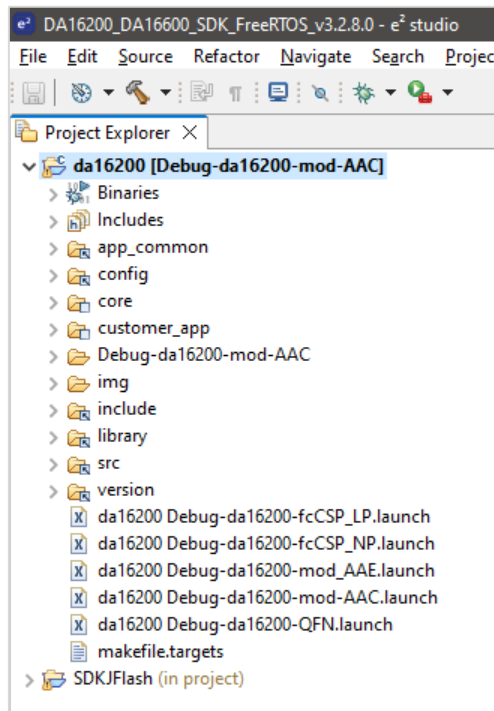

Figure 29. e<sup>2</sup> studio project explorer

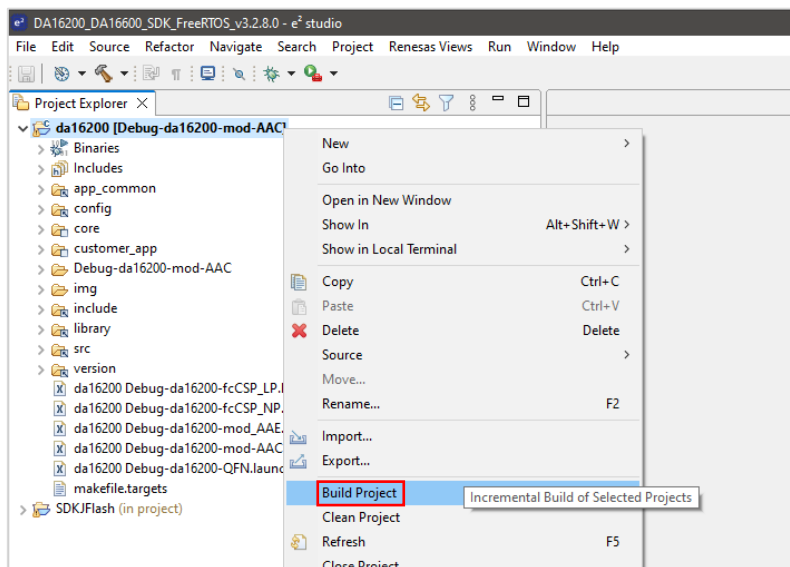

Figure 30. Build project

**NOTE**

The SDK building project process may take several minutes depending on your computer.

2. If this build process is performed for the first time, the Generate Config pop-up window is displayed automatically so that flash memory type can be selected. Select a flash type, the flash memory size and the partition size, and click **Generate** to create the appropriate flash configuration file required to build the firmware.

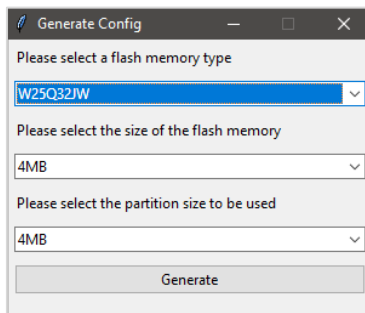

Figure 31. Generate configuration

If the pop-up window is closed without selecting and generating a configuration file, a warning pop-up is displayed.

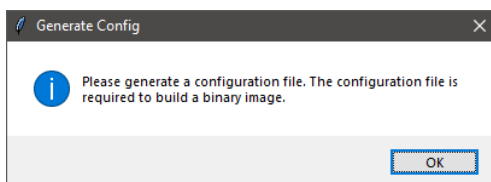

Figure 32. Generate configuration warning pop-up

When this step is complete, a flash configuration and `sflash_size.h` file are generated as they are required to build the SDK. Therefore, this step cannot be skipped. When the build is complete, the following output is displayed in the e<sup>2</sup> studio console window.

**NOTE**

If SDK version is v3.2.9.0 or higher, the `sflash_size.h` file is generated during serial flash configuration procedure. If the `sflash_size.h` file is missing, SDK build error occurs. To deal with that, re-generate serial flash configuration. For regeneration, see Section 5.5.2.

```
*-----
*Image Generate success
*-----

[CM.3.secuboot.bat] END
[.\util\mk_sboot_image.bat] END
*=====
*Post-Build Clean Start for Windows
*=====
Start mk_sboot_image_clean.bat
*=====
*Post-Build End for Windows
*=====

arm-none-eabi-size --format=berkeley "da16200.elf"
   text    data    bss    dec    hex filename
1145404  10224  141152 1296780 13c98c da16200.elf

15:56:21 Build Finished. 0 errors, 0 warnings. (took 4m:10s.749 ms)
```

There are two firmware images created by the build process, and they are stored in the `<sdk_root_directory>/<project_path>/img/` directory. For Example:

```
DA16200_FBOOT-GEN01-01-c7f4c6cc22_W25Q32JW.img
DA16200_FRTOS-GEN01-01-07b24d20f4-006526.img
```

The images can be found in the directory shown in Figure 33.

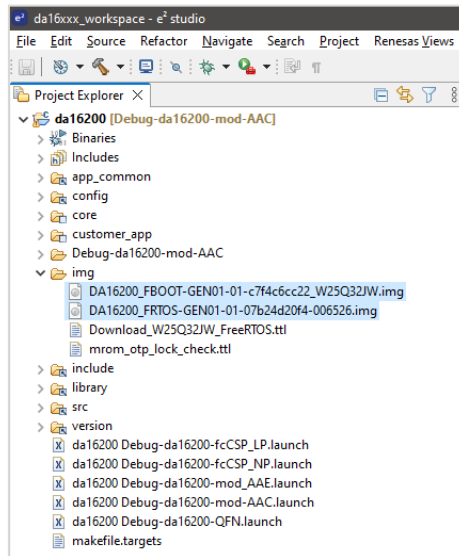

Figure 33. Location of firmware image files

**FBOOT** is a bootloader image which is used to initialize the DA16200 and launch the main firmware.

- The bootloader image should be loaded first into the flash of a new device.
- The bootloader image contains SFDP (flash specific) information.  
Note that the bootloader must be loaded into flash before loading any other images.
- When updating the SDK, always load the bootloader image first.

**FRTOS** is the main firmware image which includes RTOS and user applications.

### 5.5.1 Build Configurations

There are several types of build configuration for DA16200/DA16600 SDK project. Release and Debug configurations are almost the same except for disabling the console (UART0) input and output in the Release build configurations, see [Figure 34](#).

- DA16200 Build Configurations
  - Debug
    - Debug-da16200-mod-AAC: DA16200 AAC module type (default)
    - Debug-da16200-mod-AAE: DA16200 AAE module type Debug Build
    - Debug-da16200-QFN: DA16200 QFN chipset type Debug Build
    - Debug-da16200-fcCSP\_LP: DA16200 fcCSP Low Power chipset type Debug Build
    - Debug-da16200-fcCSP\_NP: DA16200 fcCSP Normal Power chipset Type Debug Build
  - Release
    - Release-da16200-mod-AAC: DA16200 AAC module type Release Build
    - Release -da16200-mod-AAE: DA16200 AAE module type Release Build
    - Release -da16200-QFN: DA16200 QFN chipset type Release Build
    - Release -da16200-fcCSP\_LP: DA16200 fcCSP Low Power chipset type Release Build
    - Release -da16200-fcCSP\_NP: DA16200 fcCSP Normal Power chipset Type Release Build

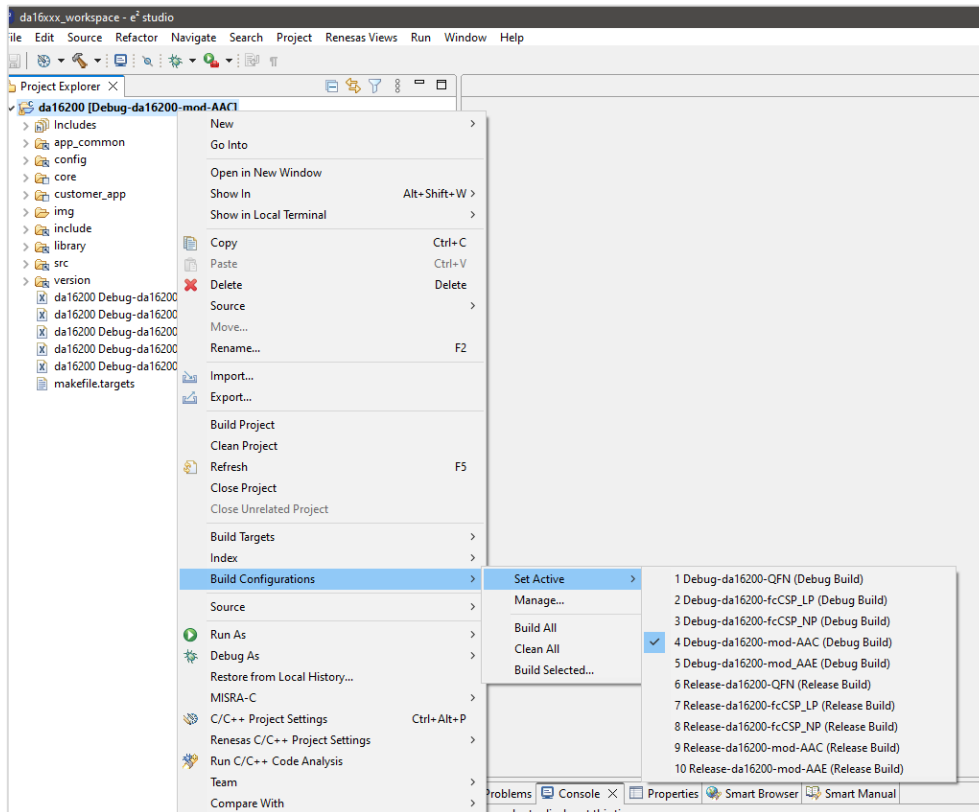

Figure 34. DA16200 build configurations

- DA16600 Build Configurations, see [Figure 35](#).
  - Debug
    - Debug-da16600-mod: DA16600 module type Debug Build (default)
  - Release
    - Release-da16600-mod: DA16600 module type Release Build

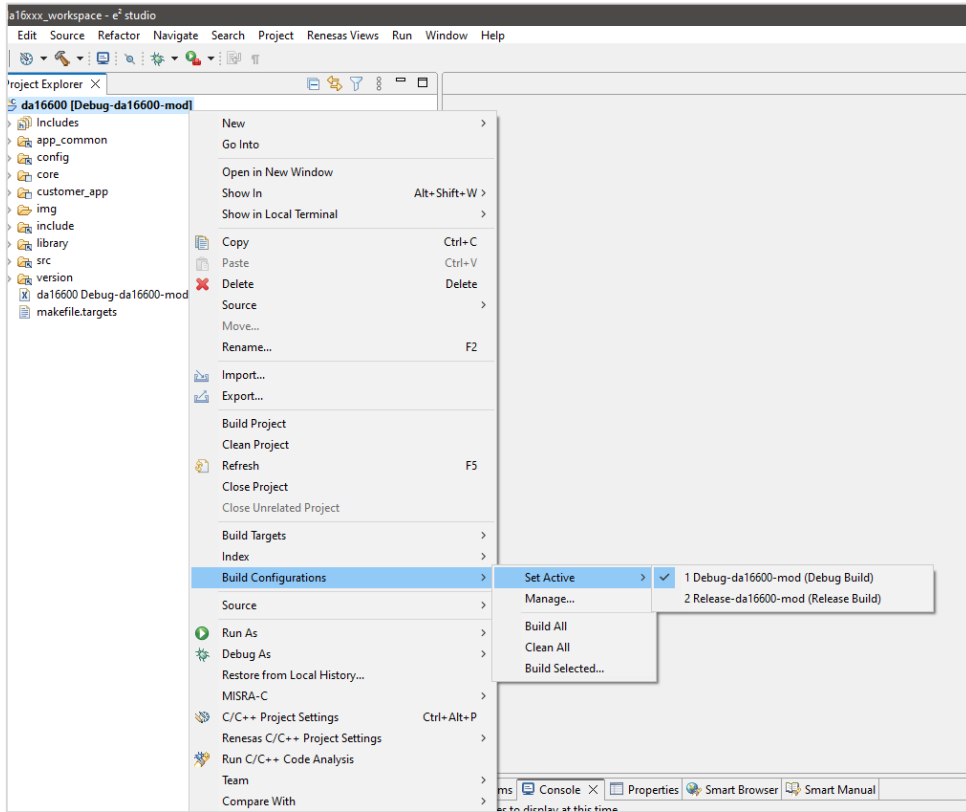

Figure 35. DA16600 build configurations

### 5.5.2 Change Flash Configuration

The flash configuration can be changed by running the Generate Configuration tool which is provided by the SDK.

To use the Generate Configuration tool, import Launch Configurations.

1. Open **File > Import > Run/Debug > Launch Configurations**.

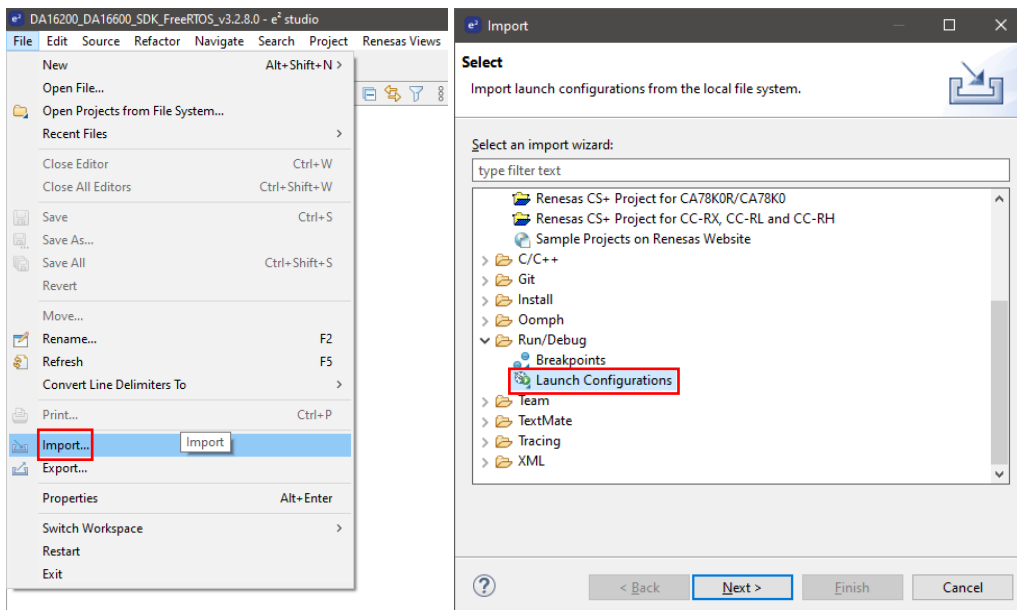

Figure 36. Import launch configuration

2. Click the **Browse** button and select `<sdk_root_directory>/utility/cfg_generator` directory.



3. Select Generate Configuration launch file and click **Finish**.

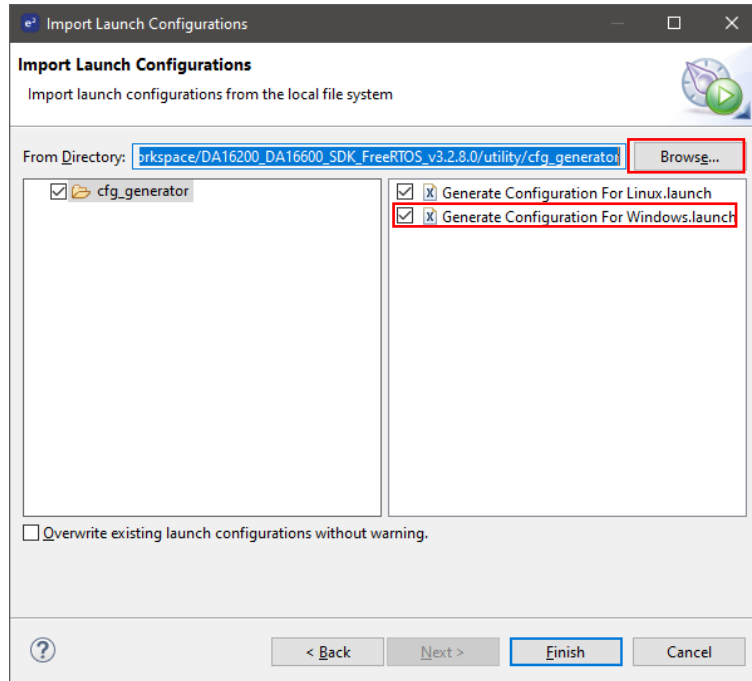

Figure 37. Import generate configuration

4. To run Generate Configuration go to the **Run > External Tools** menu and select either **Generate Configuration For Windows** or **Generate Configuration For Linux**.

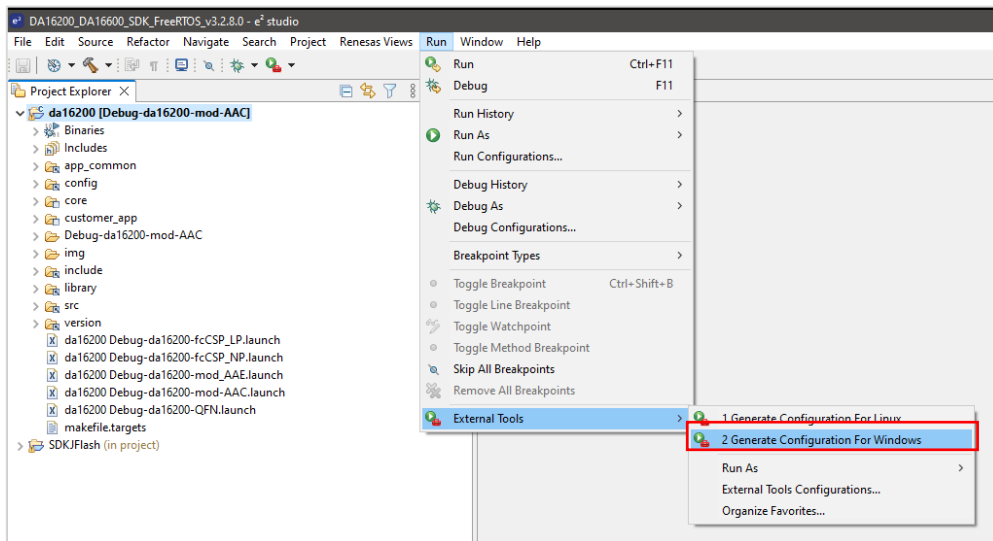

Figure 38. Run generate configuration

The Generate Configuration pop-up window is displayed as shown in Figure 31.

5. Select the flash type, and then, to create the appropriate flash configuration file required to build the firmware, click **Generate**.

### 5.5.3 How to Move Project Location

Project location can be moved to another folder. To move the project location, change the variables of SDKROOT and SDKRootDir in the e2 studio.

SDKROOT/SDKRootDir paths are the SDK Root path from the project location. (SDKROOT and SDKRootDir must be the same path.)

- e<sup>2</sup> studio > Project > Properties > Resource > Linked Resources > SDKROOT
- e<sup>2</sup> studio > Project > Properties > C/C++ Build > Build Variable > SDKRootDir

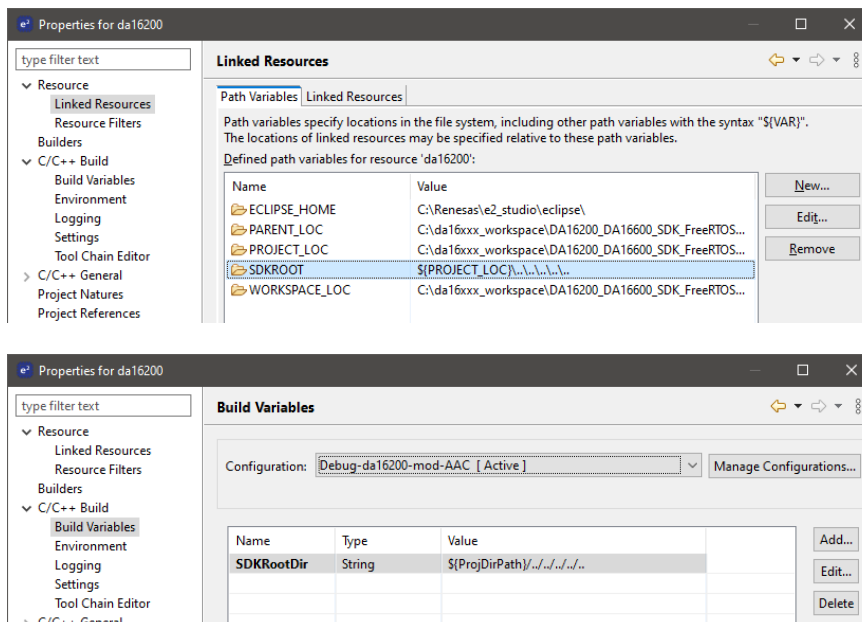

Figure 39. SDK root path variables

## 5.6 Debugging with J-Link Debug Probe

### 5.6.1 Install J-Link

To debug the DA16200/DA16600, a J-Link debug probe and the J-Link software are required.

A list of the available debug probes can be found on the Segger website:

<https://www.segger.com/products/debug-probes/j-link/models/model-overview/>

The J-link software can be downloaded from the Segger website (<https://www.segger.com/downloads/jlink>). Download and install the latest version for your device's OS.

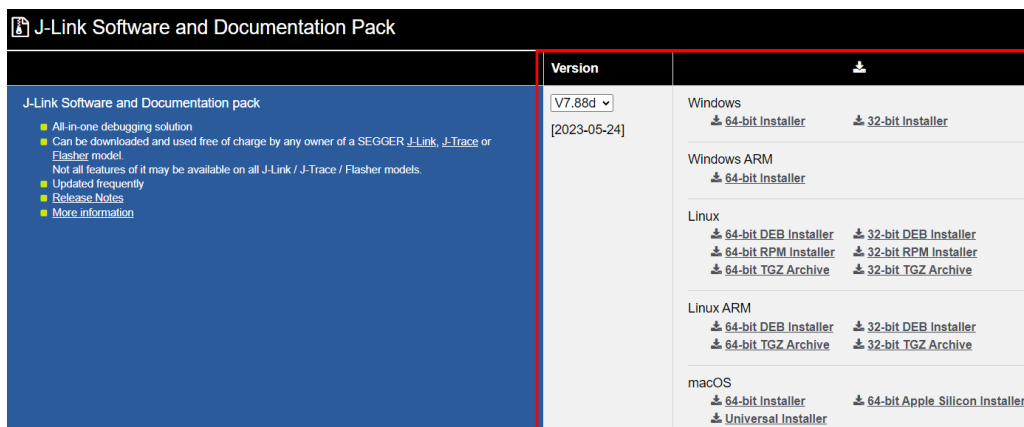

Figure 40. Download J-Link software

To install Windows version, run the installer downloaded from the Segger website. Install the Linux version using the following command:

```

$
$ sudo dpkg -i JLink_Linux_V812a_x86_64.deb
$
    
```

## 5.6.2 Connect J-Link

This section describes how to connect the J-Link debug probe to the DA16200. Connect the 20-pin connector of the "J-Link 9-pin Cortex-M Adapter" to the J-Link debug probe and connect the 9-pin connector to the "JTAG connector" on the DA16200/DA16600 EVB board.



### J-Link 9-pin Cortex-M Adapter

The J-Link 9-pin Cortex-M Adapter allows JTAG, SWD and SWO connections between J-Link and Cortex-M based target hardware systems. It adapts from the 20-pin 0.1" JTAG connector to a 9-pin 0.05" Samtec FTSH connector as defined by ARM.

The J-Link 9-pin Cortex-M Adapter may also be used to connect J-Link to a non Cortex-M target as far as the target connector uses the same pinout as shown below.

By default, TRST is not connected, but the Cortex-M Adapter comes with a solder bridge (NR1) which allows TRST to be connected to pin 9 of the Cortex-M adapter.



Figure 41. J-Link 9-pin Cortex-M Adapter

The DA16600 EVB (not DA16200 EVB) has a built-in JTAG interface which can be used for either DA16200 or DA14531. It is available for DA14531 when the SW4 – Pin 3 and Pin 4 are on. To use it for the DA16200, complete the following. See [Figure 42](#).

Configuration for DA14531:

- Switch on the SW4 – Pin 3 and Pin 4.

Configuration for DA16200:

- Switch off SW4 Pin 3 and Pin 4 to disconnect to DA14531.
- Connect P5 – Pin 1 (SWDIO) and Pin 2 (SWCLK) to CN7 Pin 2 (JTAG\_TMS) and Pin 1 (JTAG\_TCLK).
- Connect the USB cable on CN6 to a personal computer.

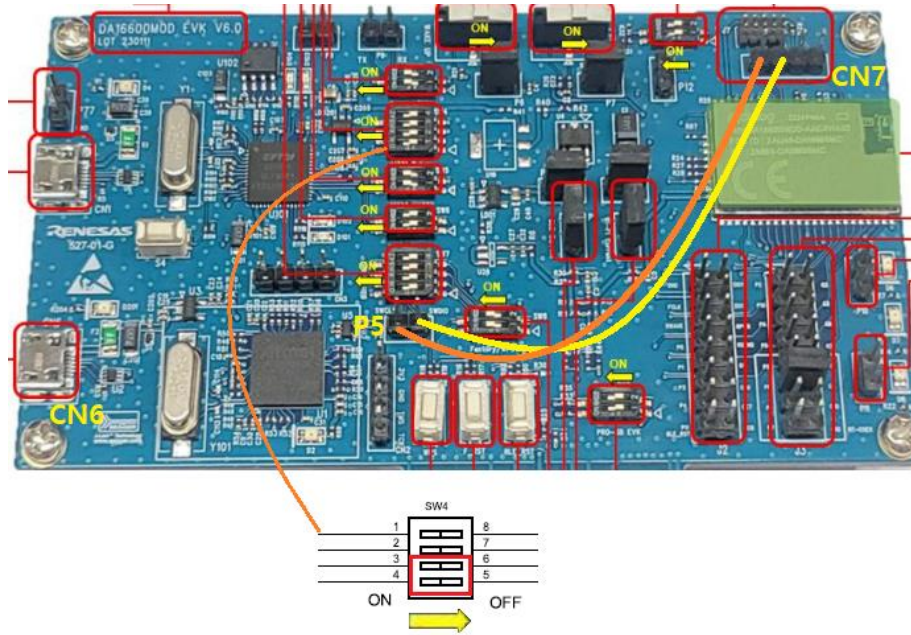

Figure 42. Configure built-in JTAG for DA16200

### 5.6.3 Run Debug Mode

1. To debug an application, in the project explorer, right-click and select **Debug As > Debug Configurations**.

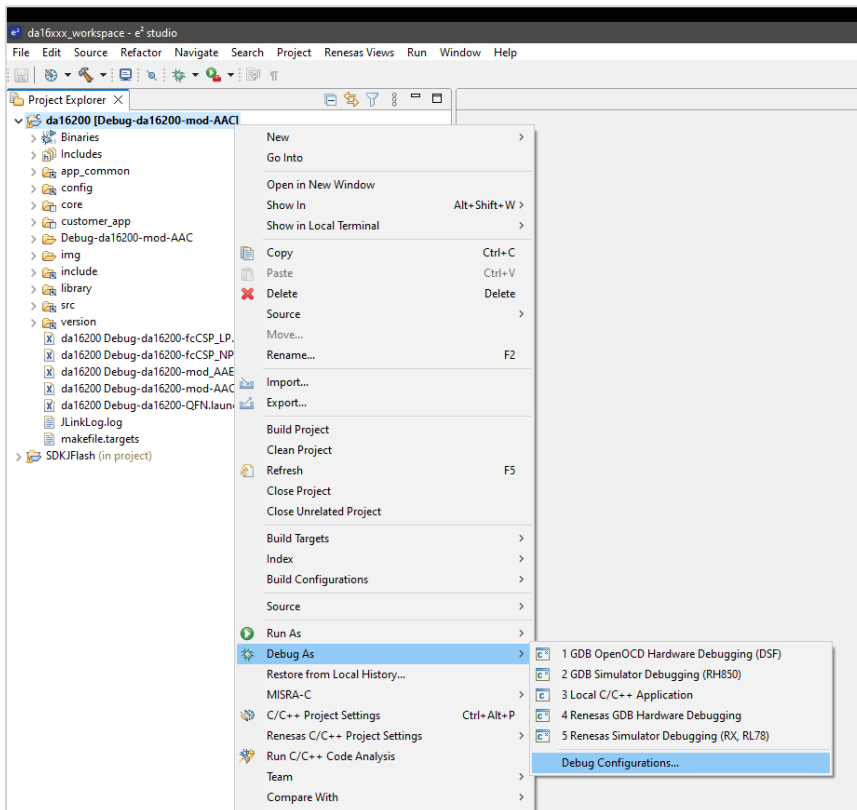

Figure 43. Run Debug mode

- Open the **Renesas GDB Hardware Debugging** entry from the list and select one of debugging configurations and click **Debug**.

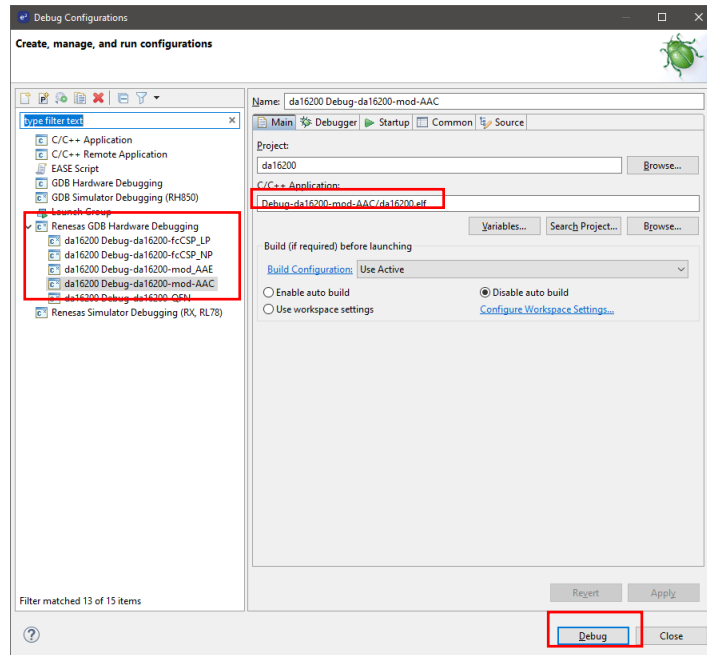

Figure 44. Select debug configuration

**NOTE**

The current FreeRTOS SDK does not support automatic downloading of the firmware image into Flash through the e<sup>2</sup> studio debug interface. Therefore, the firmware must be loaded into SFlash before starting to debug the application.

## 5.7 Program Firmware Images in e<sup>2</sup> studio

### 5.7.1 Import Launches for Programming Firmware Images

Prerequisites:

- **SDKJFlash** project must be imported before programming (see Section 5.4 and Figure 27).
- **Python 3.8** must be installed to use jlink\_XXX\_py scripts.
- **For Linux OS**
  - Check the python version in the terminal using the command as follows: `python --version`.
  - If **Command 'python' not found** error occurs, make sure to create a symbolic link for python command.

```
sat@sat-OptiPlex-7050:~$ python --version
Command 'python' not found, did you mean:
  command 'python3' from deb python3
  command 'python' from deb python-is-python3
```

Figure 45. Python command

- Create a symbolic link for python command as follows: `sudo ln -s /usr/bin/python3 /usr/bin/python`.
- If access to serial interface is denied, permission should be changed as follows: `sudo usermod -a -G dialout <username>`.

Firmware images can be programmed using launches in e<sup>2</sup> studio. The launches can be imported:

1. Click **File > Import** and select **Run/Debug > Launch Configurations**.

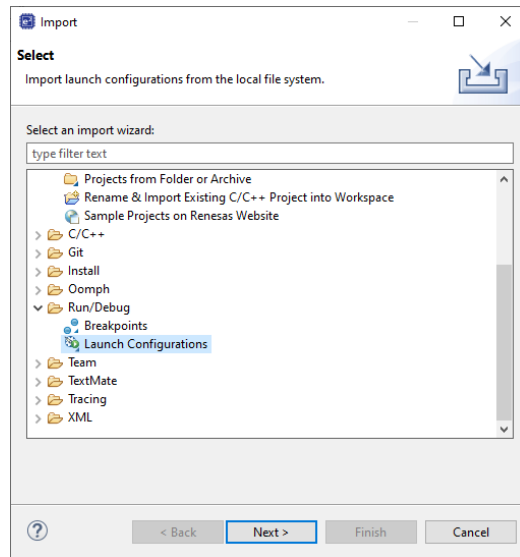

**Figure 46. Import launches**

2. Click **Next**, browse `<sdk_root_directory>\utility\j-link\scripts\qspi` and select **win**, **Linux**, or **Python** in `<sdk_root_directory>\utilitil\j-link\scripts\qspi` based on the desired environment.

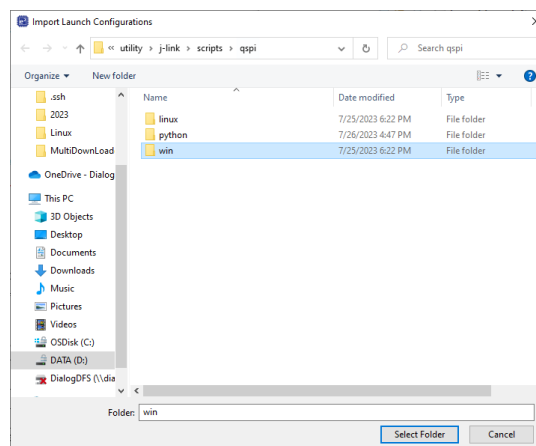

**Figure 47. Browse folder**

3. Click **Select Folder** and select launch configurations.

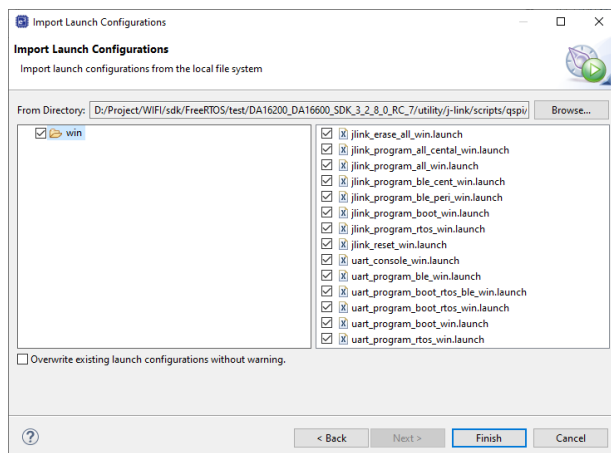

Figure 48. Select launch configurations

4. Click **Finish** and confirm launch configurations in **Run > External Tools** menu.

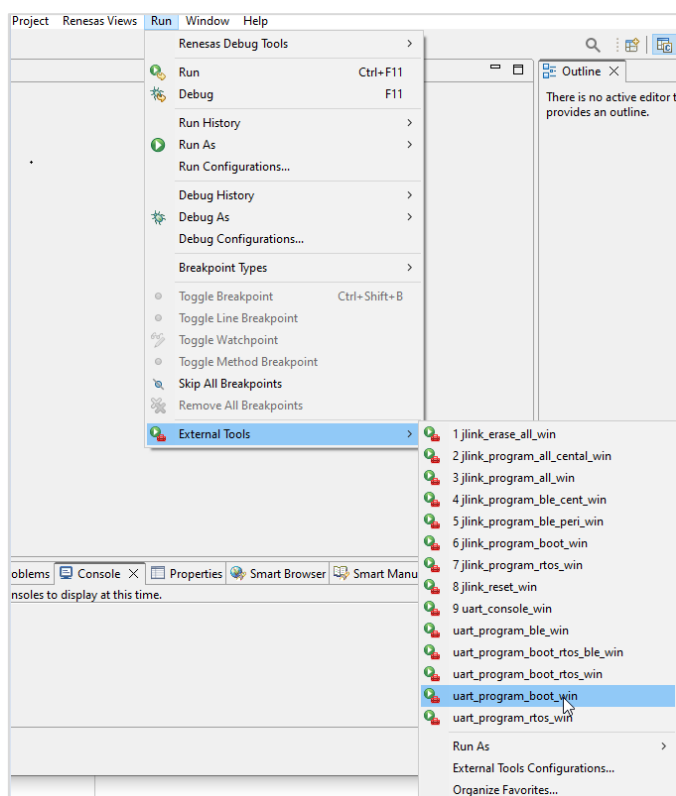

Figure 49. Launch configurations for programming firmware images

### 5.7.2 Program Firmware Images over Serial Interface

The firmware image can be programmed over a serial interface. The requirements are:

- e<sup>2</sup> studio 2023-07 (23.7.0) or later
- Python 3.8 and pyserial package (optional)

The following launches are included in the SDK:

- `uart_program_boot_win(linux/py)`: Program FBOOT image
- `uart_program_rtos_win(linux/py)`: Program FRTOS image
- `uart_program_boot_rtos_win(linux/py)`: Program FBOOT and FRTOS image
- `uart_program_ble_win(linux/py)`: Program Bluetooth firmware image (for DA16600)

- `uart_program_boot_rtos_ble_win(linux/py)`: Program FBOOT, FRTOS, and DA14531 firmware image (for DA16600)

To program the firmware image:

1. Select Project and Launch in **Run > External Tools** menu.
2. Select a proper **number** based on the device from the list of serial interfaces in the console terminal.

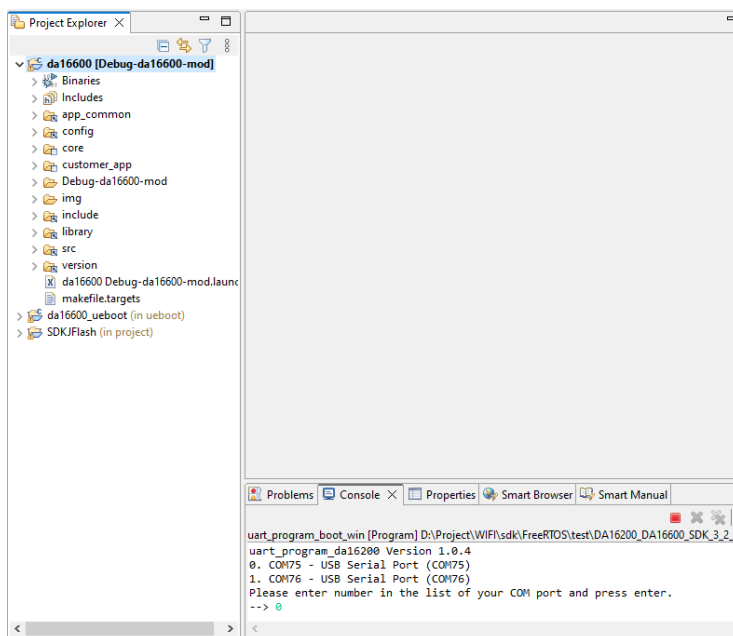

**Figure 50. Select number from serial interface list**

The programming is done automatically and confirms it is done successfully.

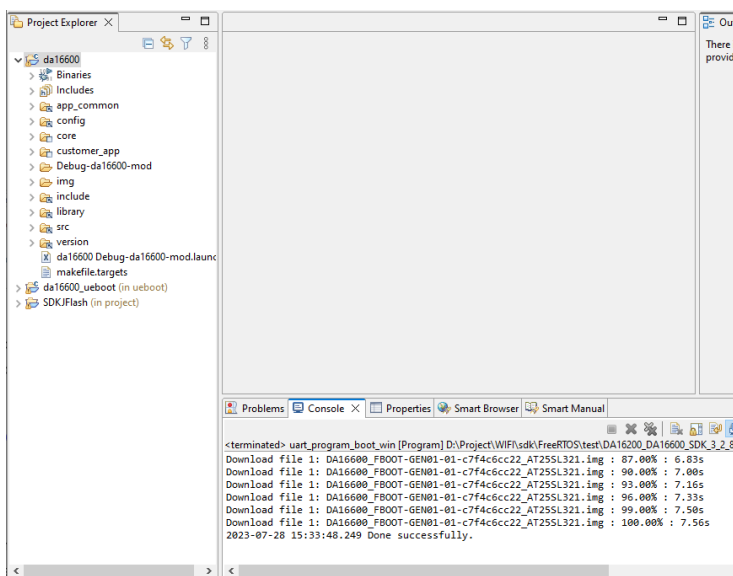

**Figure 51. Programming firmware image over serial interface**

There is a case that the console interface is disabled when the firmware image is built in release build configuration or when the DA16200/DA16600 is in DPM low power mode. To program the firmware image for this case, complete the following steps. When the DA16200/DA16600 does not boot properly, and serial command interface is unresponsive, see Appendix [D.1.2](#).

1. Program the firmware image using SEGGER J-Link as shown in Section [5.7.3](#).
2. Or, program firmware image over serial interface (See [Figure 52](#)):
  - a. Turn off the device.



- b. Run `uart_console_win (linux, py)` launch in **Run > External Tools** menu.
- c. Select port number and enter `emode` for running emergency mode.
- d. Follow the instructions in the Console and confirm the device enters MROM state.
- e. Exit the `uart_console_win (linux, py)` by entering `Exit` or clicking **Terminate**.
- f. Run `uart_program_xxx` launch for programming firmware image as usual.

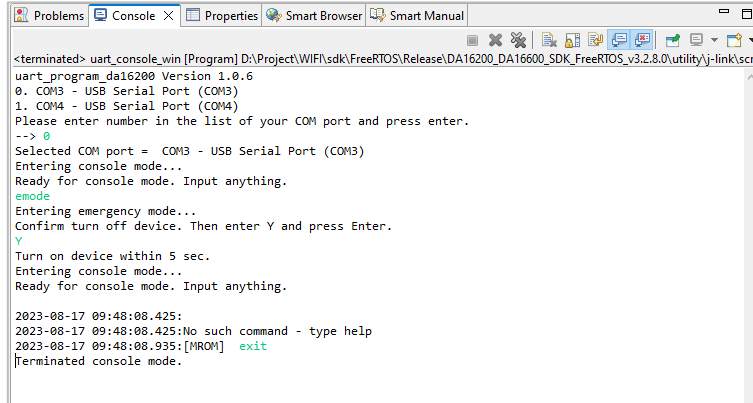

Figure 52. Emergency mode for programming firmware image

**NOTE**

If `uart_program_xxx` runs without exiting `uart_console_win (linux, py)`, it fails to open the serial interface. In this case, the `uart_console_win (linux, py)` should be terminated by clicking **Remove All Terminated Launches** and **Terminate** icon in the Console terminal.

### 5.7.3 Program Firmware Images Using SEGGER J-Link

The firmware image also can be programmed using Segger J-Link. The requirements are as follows:

- J-Link Debug Probes (J-Link LITE or higher versions)  
See: <https://www.segger.com/products/debug-probes/j-link/models/model-overview/>
- e<sup>2</sup> studio 2023-07 (23.7.0) or later
- Python 3.8 (optional)

The J-Link setup procedure required to work with J-Flash which was described in the [J-Link / J-Trace User Guide \(UM08001\)](#). The following scripts are included in the SDK:

- `jlink_erase_all_win(linux/py)`: Erase all area of the flash
- `jlink_program_all_win(linux/py)`: Program all images
- `jlink_program_boot_win(linux/py)`: Program FBOOT image
- `jlink_program_rtos_win(linux/py)`: Program FRTOS image
- `jlink_program_all_central_win(linux/py)`: Program all images for Bluetooth central role (for DA16600)
- `jlink_program_ble_peri_win(linux/py)`: Program Bluetooth image for a peripheral (for DA16600)
- `jlink_program_ble_cent_win(linux/py)`: Program Bluetooth image for a central role (for DA16600)

The programming can be completed by selecting the project and launch in **Run > External Tools** menu as shown in [Figure 53](#).

**NOTE**

For J-Link GDB server connection, use the J-Link GDB server software. J-Link is connected through USB and target interface is SWD. Select a target device like Cortex-M33 and speed should be 4000 kHz. For more information, visit the [J-Link GDB Sever](#).

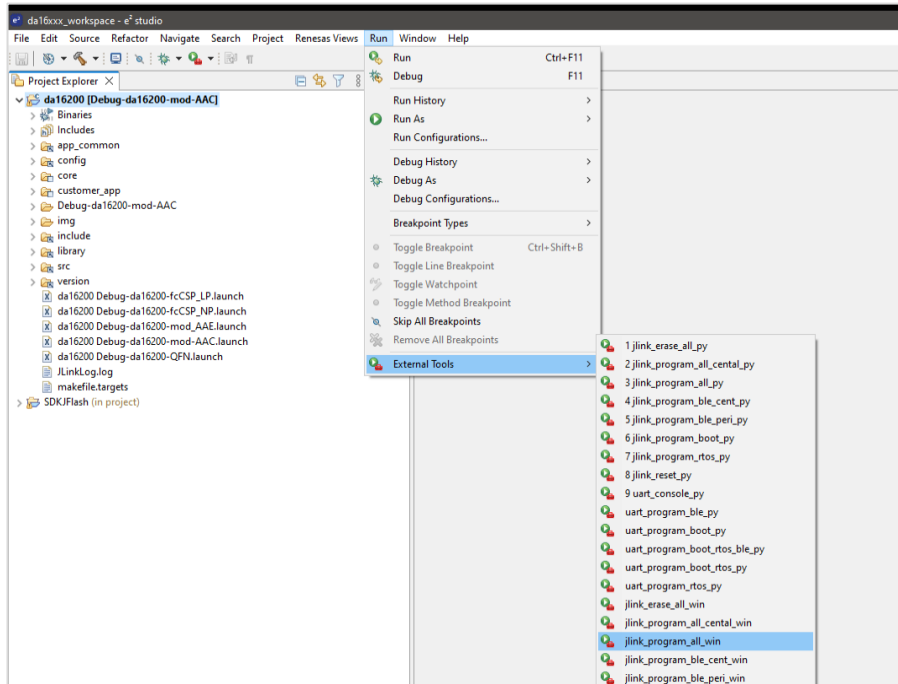

Figure 53. Run J-Link launch

Other methods for programming the firmware images are described in Section 4.5.

## 5.8 Migrate IDE from Eclipse to e<sup>2</sup> studio for Old SDKs

The old SDKs (before SDK 3.2.8) also can be used in the e<sup>2</sup> studio. To migrate, complete the following steps.

1. Delete .project in root folder of the old SDK.
2. Delete all folders and files in <sdk\_root\_directory>\utility\j-link\scripts\qspi\.
3. Copy all folders and files in <sdk\_root\_directory>\utility\j-link\scripts\qspi\ of SDK 3.2.8 (or later) to <sdk\_root\_directory>\utility\j-link\scripts\qspi\ of old SDK.
4. Install e<sup>2</sup> studio, create workspace, import projects, and import launches.

## 6. Test Procedures

### 6.1 Introduction

This section describes various tests that verify the proper operation of the DA16200/DA16600 and demonstrate its features.

The tests include:

- Ping Test: verify the connection between the DA16200/DA16600 and another device connected to the same AP.
- Throughput Test: demonstrate the Wi-Fi performance of the DA16200/DA16600.
- DPM Setup: demonstrate the various power modes of the DA16200/DA16600.
- Current Test: demonstrate the amount of power consumed when the DA16200/DA16600 is in Sleep mode.

### 6.2 Ping Test

Ping is a standard application that is used to verify if devices exist on a network. This test procedure demonstrates that the DA16200/DA16600 responds to ping commands while in DPM low power mode.

#### 6.2.1 Test Setup

The ping communication test requires an access point (AP) and two stations consisting of a DA16200 or DA16600 EVB and a desktop. The two stations must be connected to the same subnetwork AP as shown in Figure 54.

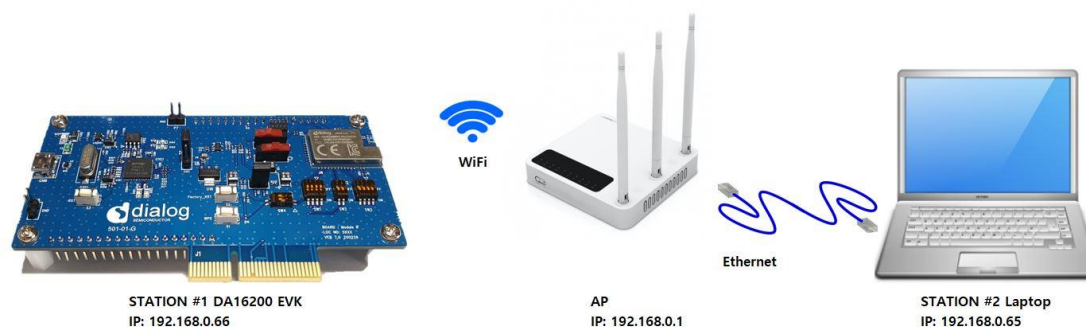

Figure 54. Ping test environment

The DA16200 must be connected to the AP through Wi-Fi, and the laptop must be connected to the AP with an Ethernet cable. After the DA16200/DA16600 is configured, it goes into DPM Low-power mode and only wakes up from the Low-power mode when unicast packets are received.

In this test, a ping application which runs on the laptop acts as a network peer that sends a unicast packet to the DA16200/DA16600. This shows that when the DA16200/DA16600 is in DPM low power mode, it can successfully wake up and receive the unicast packets in real-time. For the ping communication test, complete the following steps.

1. On the laptop, open a Command Prompt as an administrator.
2. Run the `ipconfig` command to list the IP address of the network adaptor.

```
C:\user\testuser>ipconfig

Windows IP Configuration

Ethernet adapter Ethernet 4:

Connection-specific DNS Suffix . . :
    Link-local IPv6 Address . . . . . : fe80::4c8:3627:424b:1951%20
    IPv4 Address. . . . . : 192.168.0.65
    Subnet Mask . . . . . : 255.255.255.0
```

```
Default Gateway . . . . . : 192.168.0.1
```

In this case, the IP address is 192.168.0.65 and the default gateway is 192.168.0.1.

3. Open a serial terminal and connect to the DA16200 serial debug port.
4. Configure the DA16200/DA16600 to operate in station mode as described in Section 4.6.1.
5. When the DA16200/DA16600 is configured, reboot and check the output to get the assigned IP address.

```
Connection COMPLETE to 80:ca:4b:30:02:0a
-- DHCP Client WLAN0: SEL(6)
-- DHCP Client WLAN0: REQ(1)
-- DHCP Client WLAN0: CHK(8)
-- DHCP Client WLAN0: BOUND(10)
    Assigned addr   : 192.168.0.66
        netmask     : 255.255.255.0
        gateway     : 192.168.0.1
        DNS addr    : 61.41.153.2
    DHCP Server IP  : 192.168.0.1
    Lease Time      : 06h 00m 00s
    Renewal Time    : 03h 00m 00s
```

In this case, the assigned IP for the DA16200/DA16600 is 192.168.0.66.

6. To verify the setup, run a ping command using the IP address of the DA16200/DA16600.

```
C:\user\testuser>ping 192.168.0.66
Pinging 192.168.0.66 with 32 bytes of data:
Reply from 192.168.0.66: bytes=32 time=81 ms TTL=255
Reply from 192.168.0.66: bytes=32 time=14 ms TTL=255
Reply from 192.168.0.66: bytes=32 time=18 ms TTL=255
Reply from 192.168.0.66: bytes=32 time=25 ms TTL=255
Ping statistics for 192.168.0.66:
    Packets: Sent = 4, Received = 4, Lost = 0 (0% loss),
Approximate round trip times in milli-seconds:
    Minimum = 14 ms, Maximum = 81 ms, Average = 34 ms
```

### 6.2.2 Perform Ping Test with DPM Enabled

When the environment is ready and simple ping is working, perform the ping test with DPM enabled.

1. Enable DPM as described in Section 6.4.7.1.  
When DPM is enabled, the DA16200/DA16600 goes into DPM Low Power mode.
2. On your laptop, run the ping command using the IP address of the DA16200/DA16600.

```
C:\user\testuser>ping 192.168.0.66
Pinging 192.168.0.66 with 32 bytes of data:
Reply from 192.168.0.66: bytes=32 time=81 ms TTL=255
Reply from 192.168.0.66: bytes=32 time=14 ms TTL=255
Reply from 192.168.0.66: bytes=32 time=18 ms TTL=255
Reply from 192.168.0.66: bytes=32 time=25 ms TTL=255
Ping statistics for 192.168.0.66:
```

```
Packets: Sent = 4, Received = 4, Lost = 0 (0% loss),
Approximate round trip times in milli-seconds:
    Minimum = 14 ms, Maximum = 81 ms, Average = 34 ms
```

For each ping packet sent, the DA16200/DA16600 wakes up and prints a message on the serial terminal and then returns to the Low-power mode:

```
Wake-up source is 0x82
>>> TIM STATUS: 0x00000001
>>> TIM : UC
>>> Start DPM Power-Down !!!
rwnx_send_set_ps_mode PS TIME (us) 139351
Wake-up source is 0x82
>>> TIM STATUS: 0x00000001
>>> TIM : UC
>>> Start DPM Power-Down !!!
rwnx_send_set_ps_mode PS TIME (us) 179263
Wake-up source is 0x82
>>> TIM STATUS: 0x00000001
>>> TIM : UC
>>> Start DPM Power-Down !!!
rwnx_send_set_ps_mode PS TIME (us) 129354
```

To disable or change the DPM settings, see Section [6.4.7.2](#).

### 6.2.3 Add ARP Record

This section describes how to add a DHCP assigned IP address to the ARP table and change that IP address from a dynamic to a static IP address.

If the DA16200/DA16600 is in DPM low-power mode and there is multiple network interfaces enabled, an ARP entry must be added for the specific interface so that the laptop knows how to find the DA16200/DA16600. Since retransmission logic is not included in the higher protocol (TCP/UDP), an additional ARP record is required for ping tests between the laptop and the DA16200/DA16600 which is operating in DPM low-power mode.

1. To manually add an ARP record to the ARP cache, use the `arp -s` command and then to view the ARP table for the network interface, use the `arp -a` command.

```
C:\user\testuser>arp -s 192.168.0.66 d4-3d-39-10-a2-48
C:\user\testuser>arp -a
Interface: 192.168.0.105 --- 0x12

    Internet Address      Physical Address      Type
    192.168.0.1           80-ca-4b-30-02-09    dynamic
    192.168.0.66         d4-3d-39-10-a2-48   dynamic
    192.168.0.255        ff-ff-ff-ff-ff-ff    static
    224.0.0.2            01-00-5e-00-00-02    static
    224.0.0.22           01-00-5e-00-00-16    static
    224.0.0.251          01-00-5e-00-00-fb    static
    239.255.255.250      01-00-5e-7f-ff-fa    static
    255.255.255.255      ff-ff-ff-ff-ff-ff    static
```

The IP address (192.168.0.66) of the DA16200 is now added to the ARP table as a dynamic type.

**NOTE**  
 When setting up the ARP cache to static with the command `arp -s` on higher versions of Windows, an error such as Failed to add ARP entry, Access is denied occurs. Renesas recommends using `netsh` to change the network settings.

2. To find the interface name, use the command `netsh interface show interface`.

```
C:\user\testuser>netsh interface show interface

Admin State      State           Type           Interface Name
-----
Enabled         Connected      Dedicated      Ethernet
Enabled         Disconnected   Dedicated      Wi-Fi
```

3. To set the ARP cache to static with the `netsh` command, use the interface name of DA16200 and then to verify that it is now a static ARP entry, use `arp -a`.

```
C:\user\testuser>netsh interface ip add neighbors "Ethernet" "192.168.0.66" "d4-3d-39-10-a2-48"
C:\WINDOWS\system32>arp -a
Interface: 192.168.0.105 --- 0x12

Internet Address      Physical Address      Type
192.168.0.1           80-ca-4b-30-02-09    dynamic
192.168.0.66         d4-3d-39-10-a2-48    static
192.168.0.255         ff-ff-ff-ff-ff-ff    static
224.0.0.2             01-00-5e-00-00-02    static
224.0.0.22           01-00-5e-00-00-16    static
224.0.0.251          01-00-5e-00-00-fb    static
239.255.255.250      01-00-5e-7f-ff-fa    static
255.255.255.255      ff-ff-ff-ff-ff-ff    static
```

The IP address (192.168.0.66) of the DA16200 is now added to the ARP table as a static type.

4. To initialize the ARP cache, use the command `arp -d` or `netsh interface ip delete arpccache`.

### 6.3 Throughput Test

This section describes how to perform the throughput test using the TCP client/server protocol. The DA16200 has `iperf` command for measuring throughput performance. To perform the throughput test, prepare the DA16200 to operate in station mode and disable DPM as described in Sections 4.6.1 and Section 6.4.7.2 respectively.

#### 6.3.1 Test Setup



Figure 55. Throughput test environment

The `iPerf` tool should be installed on the laptop. Renesas recommends installing **iPerf Version 2.0.8**.

**NOTE**

iPerf 3.x is not supported.

To set up iPerf tool:

1. Download iPerf from <https://iperf.fr/iperf-download.php>.
2. Create a folder called **iPerf** in path **C:\**.
3. Unzip the downloaded file and move the contents to the iPerf folder.
4. Prepare the DA16200 to operate in station mode as described in Section 4.6.1.
5. Use `iperf` or `iperf -h` command to see the available options in `iperf`.

Example:

```
[/DA16200] # net                               Switch to network command mode.
        Command-List is changed, "NET"
[/DA16200/NET] # iperf                          Run iperf command.
Usage: iperf -I [WLAN0|WLAN1] [-s|-c host][options]
        iperf [-h] [-v]
Client/Server:
        -I      Interface [WLAN0|WLAN1]
        -i      seconds between periodic bandwidth reports
        -u      use UDP rather than TCP
        -p, #   server port to listen on/connect to
        -f, [kmKM]  format to report: Kbits, Mbits, KBytes, MBytes
        -d      finsh service
                ex) iperf -d -c -u : udp clinet
                   iperf -d -c   : tcp clinet
                   iperf -d -u   : udp server
                   iperf -d     : tcp server
Server specific:
        -s      run in server mode
        -T #    Rx Time Out Min:1 sec. 'F' Forever
Client specific:
        -c      <host>  run in client mode, connecting to <host>
        -t #    time in seconds to transmit for (default 10 secs)
        -x #    tcp API mode default:basic tcp(API) 1:Altcp 2:Socket
        -y #    Transmit delay, tick 1 ~ 100
        -l #    PacketSize option (UDP default 1470, IPv6 1448 TCP 1000)
        -n #    UDP Tx packet number
        -P, #   Pair Index (0,1,2)
                (default Max, Step 1~100 Mbps)
        -O      use Main Packet Pool
Miscellaneous:
        -h      print this message
        -v      print version
```

### 6.3.2 Throughput Test with DA16200/DA16600 as Client

To set up the throughput test with the DA16200/DA16600 operating as a client and the laptop operating as a server, complete the following steps.

1. Connect the laptop which is the server to the AP.
2. To find the IP address, in the command prompt, use `ipconfig /all`.

```
C:\user\testuser>ipconfig /all

Ethernet adapter Ethernet:

    Connection-specific DNS Suffix  . : Davolink
    Description . . . . . : Realtek USB GbE Family Controller #3
    Physical Address. . . . . : 50-E0-85-D7-1E-4B
    DHCP Enabled. . . . . : Yes
    Autoconfiguration Enabled . . . . : Yes
    Link-local IPv6 Address . . . . . : fe80::ble7:a692:a700:748a%13(Preferred)
    IPv4 Address. . . . . : 192.168.0.103 (Preferred)
    Subnet Mask . . . . . : 255.255.255.0
    Lease Obtained. . . . . : Monday, September 27, 2021 4:23:16 PM
    Lease Expires . . . . . : Tuesday, September 28, 2021 4:24:33 PM
    Default Gateway . . . . . : 192.168.0.1
    DHCP Server . . . . . : 192.168.0.1
    DHCPv6 IAID . . . . . : 173072517
    DHCPv6 Client DUID. . . . . : 00-01-00-01-28-2E-4F-CA-98-E7-43-AD-7D-81
    DNS Servers . . . . . : 1.214.68.2
                               61.41.153.2
    NetBIOS over Tcpip. . . . . : Enabled
```

**NOTE**  
The IP address varies depending on the AP settings.

3. To ensure stable iPerf testing, run the Windows Security APP and turn off the network firewall. Renesas Electronics recommends disabling the laptop from all network firewalls before attempting a test as shown in [Figure 56](#).



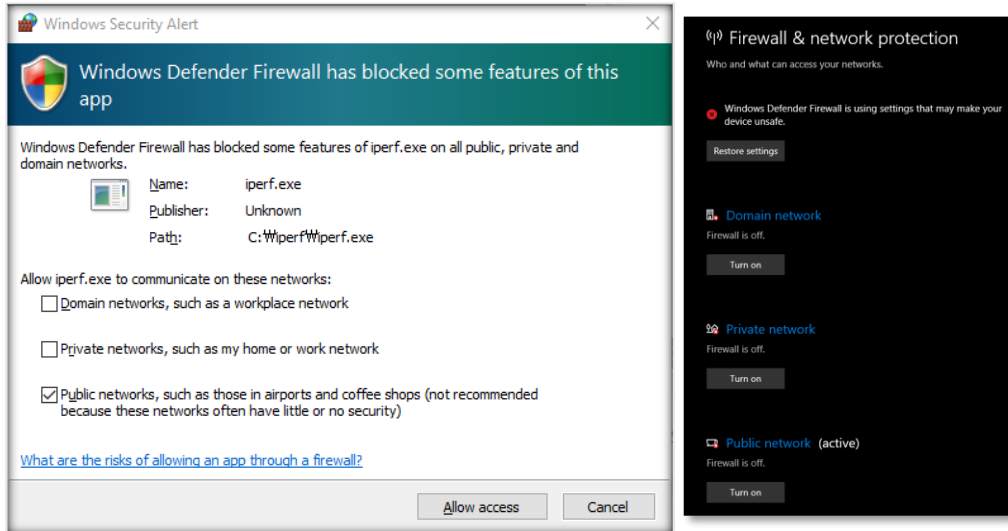

Figure 56. Disable firewall for iPerf test

- To configure the TCP server, in the command prompt, go to the directory where iPerf is installed, and type `iperf -s`.

```
c:\tools\iperf>iperf -s
Server listening on TCP port 5001
TCP window size: 208 kB (default)
```

The iPerf is now running as a server on your laptop and waiting for the DA16200/DA16600 to start the client test app.

- To run the iPerf client test on the DA16200/DA16600, in the DA16200/DA16600 console window, switch to "NET" command mode and type `iperf -I wlan0 -c 192.168.0.103 -t 5 -i 1`.

```
[/DA16200] # net                               Switch to network command mode.
Command-List is changed, "NET"
[/DA16200/NET] # iperf -I wlan0 -c 192.168.219.103 -t 5 -i 1  Run the iPerf client test.
[/DA16200/NET] #
[TCP] Tx Test (Client) ==> 192.168.219.103:5001
TCP_TX:[ No ]      [Interval]    [Transfer]          [Bandwidth]          [Dst IP:Port]
TCP_TX:[0001]     0.00- 1.00      2.070 MBytes       17.368 Mbits/sec    192.168.0.103:5001
TCP_TX:[0002]     1.00- 2.00      2.156 MBytes       18.092 Mbits/sec    192.168.0.103:5001
TCP_TX:[0003]     2.00- 3.00      2.142 MBytes       17.975 Mbits/sec    192.168.0.103:5001
TCP_TX:[0004]     3.00- 4.00      2.192 MBytes       18.396 Mbits/sec    192.168.0.103:5001
TCP_TX:[Total]   0.00- 5.00      10.801 MBytes      18.122 Mbits/sec    192.168.0.103:5001
[/DA16200/NET] #
```

Where the format of the iPerf command type is:

```
iperf -I [INTERFACE] [-s/-c] [DESTINATION IP] (-u) -i [INTERVAL TIME] -t [TEST TIME]
```

### 6.3.3 Throughput Test with DA16200/DA16600 as Server

To set up the throughput test with the DA16200/DA16600 operating as a server and the laptop operating as a client, complete the following steps.

- Power up the DA16200/DA16600 and check the assigned IP address in the DA16200/DA16600 console window:

```
Connection COMPLETE to 80:ca:4b:30:02:0a
```

```
-- DHCP Client WLAN0: SEL(6)
-- DHCP Client WLAN0: REQ(1)
-- DHCP Client WLAN0: CHK(8)
-- DHCP Client WLAN0: BOUND(10)
    Assigned addr   : 192.168.0.66
        netmask    : 255.255.255.0
        gateway    : 192.168.0.254
        DNS addr   : 61.41.153.2
    DHCP Server IP  : 192.168.0.254
    Lease Time     : 06h 00m 00s
    Renewal Time   : 03h 00m 00s

[/DA16200] #
```

2. To run the iPerf server, in the DA16200/DA16600 console window, switch to "NET" command mode and type "iperf -I wlan0 -s".

```
[/DA16200] # net                               Switch to network command mode.
    Command-List is changed, "NET"

[/DA16200/NET] # iperf -I wlan0 -s             Run Iperf in server mode.
iPerf Server(TCP): Ready

[/DA16200/NET] #
```

The DA16200/DA16600 is now running in the iPerf server mode.

3. To run the iPerf client test on the laptop, in the command prompt, type "iperf -I wlan0 -c 192.168.0.103 -t 5 -i 1".

```
C:\tools\iperf>iperf.exe -c 192.168.0.66 -t 5 -i 1           Run the iPerf client test.
Client connecting to 192.168.0.66, TCP port 5001
TCP window size: 208 KByte (default)
[ 3] local 192.168.219.105 port 53916 connected with 192.168.0.66 port 5001
[ ID] Interval      Transfer    Bandwidth
[ 3] 0.0- 1.0 sec  2.62 MBytes 22.0 Mbits/sec
[ 3] 1.0- 2.0 sec  2.50 MBytes 21.0 Mbits/sec
[ 3] 2.0- 3.0 sec  2.38 MBytes 19.9 Mbits/sec
[ 3] 3.0- 4.0 sec  2.38 MBytes 19.9 Mbits/sec
[ 3] 4.0- 5.0 sec  2.38 MBytes 19.9 Mbits/sec
[ 3] 0.0- 5.0 sec 12.2 MBytes 20.5 Mbits/sec
C:\tools\iperf>
```

The following results appear in the DA16200/DA16600 command window.

```
[TCP] Receive Test (Server)
TCP_RX:[ No ]      [Interval]  [Transfer]      [Bandwidth]
TCP_RX:[Total]    0.00- 5.13    12.250 MBytes   20.031 Mbits/sec 192.168.0.103:53916
```

## 6.4 Current Test

To measure the current waveform, connect the EVB's current test point (P2) with the testing instrument. For more information on the Sleep modes, see Ref. [1].

### 6.4.1 Test Setup – KEYSIGHT 14585A

Figure 57 shows a typical test setup environment.

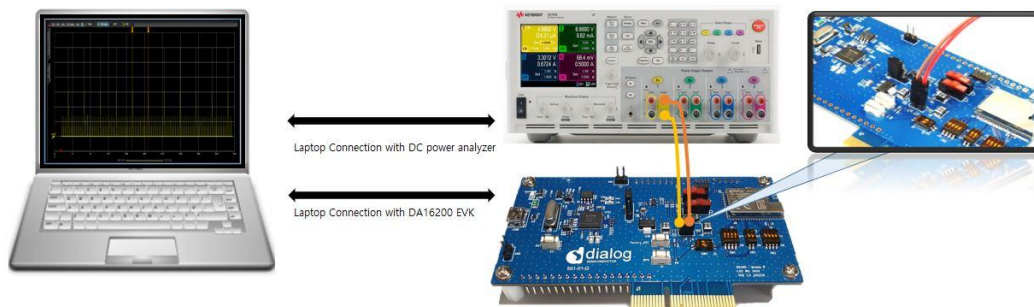

Figure 57. Current test environment with 14585A

### 6.4.2 Test Setup with EVK Pro Board

EVK Pro board is a simple evaluation board without any additional devices to measure current.

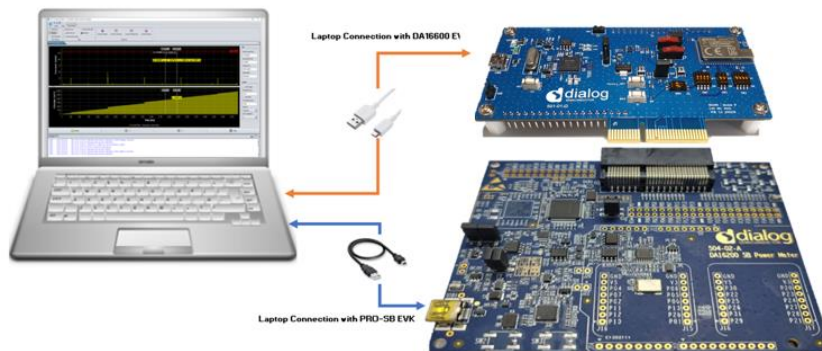

Figure 58. Current test environment with EVK Pro for DA16200

1. To measure current with DA16200 EVK Pro board, connect the two boards with the PCI connector.
2. To disconnect the USB power and source from the Pro board only, open the jumpers (P2) of the power line on the DA16200 EVB as shown in Figure 59.

Power is supplied from the EVK Pro board, and current consumption of the DA16200 can be measured.

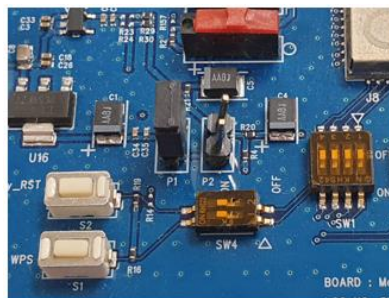

Figure 59. Set up DA16200 EVB jumper

Figure 60 shows a typical test setup environment with DA16600 EVK Pro board and Wi-Fi IoT Power Profiler Tool.

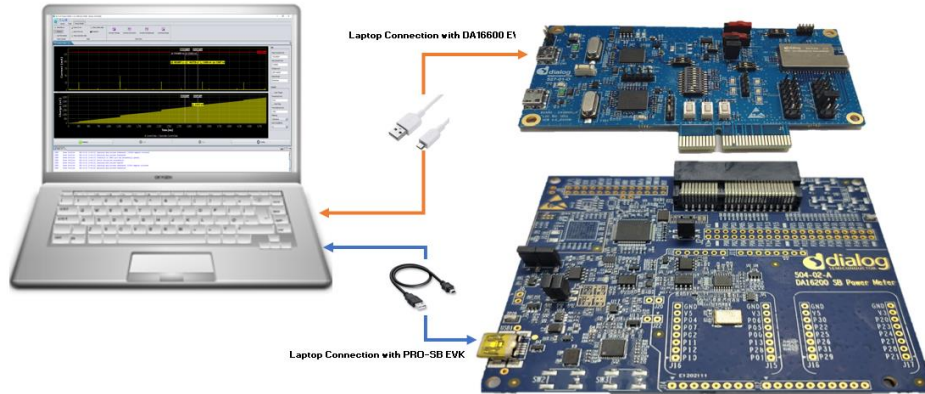

Figure 60. Current test environment with EVK Pro for DA16600

To measure current consumption with DA16600 EVK Pro board, complete the following steps.

1. Connect the two boards with the PCI connector.
2. Change the jumper setting (P1 and P2) and switch (SW5) settings on the DA16600 EVB.
3. Open the DA16600 EVB's power jumpers P1 and P2 as shown in Figure 61. DIP Switch (SW5) should be on to measure both of Wi-Fi chipset and Bluetooth LE chipset.

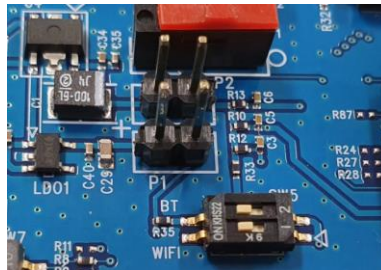

Figure 61. Set up DA16600 EVB jumper

#### 6.4.2.1 DA16200/DA16600 EVK Pro Board (504-02-A)

Figure 62 shows the component locations of the DA16200/DA16600 EVK Pro board.

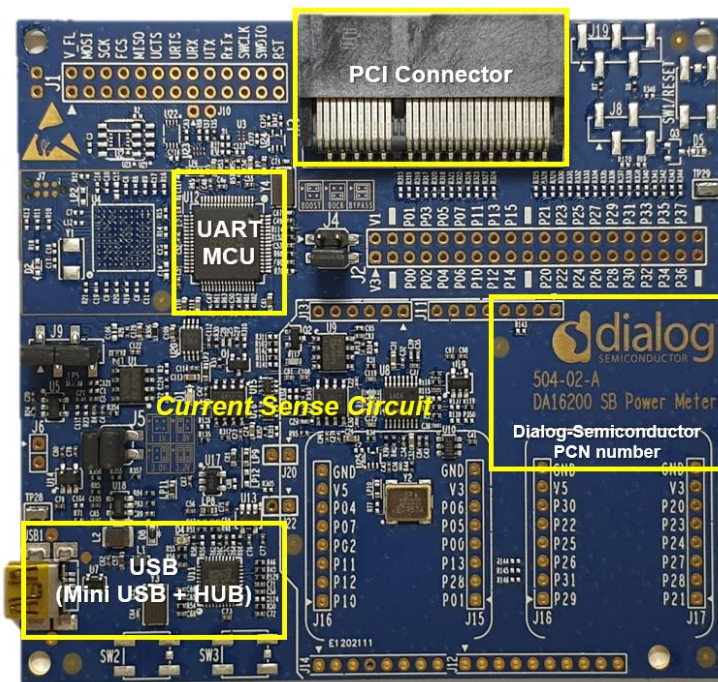

Figure 62. DA16200/DA16600 EVK Pro board (504-02-A)



- PCI Connector: a connector on which to install the DA16200/DA16600 EVB board.
- UART MCU: provides communication between DA16200/DA16600 EVK Pro board and personal computer. It also transfers the current measurement samples to the personal computer.
- Current Sense Circuit: monitors the current of the DA16200/DA16600 EVB.
- USB Hub: USB interfaces to the personal computer.

### 6.4.2.2 Wi-Fi IoT Power Profiler

Wi-Fi IoT Power Profiler uses the SPI port of a device connected through USB for communication. You need to select the SPI port to connect before using the Power Profiler tool.

To select the SPI port, click the checkbox next to the SPI port. The port can be preselected already since the application remembers the last selected SPI port. If necessary, use the **Refresh** button to update the list of available SPI ports for the devices connected using USB. If the device is connected but not listed, it is better to use a different USB port, wait for a few seconds, and then click the **Refresh** button again. Problems in identifying the FTDI device may indicate an invalid installation of the FTDI drivers.

The  button can be used to access the application's user guide, release notes, license, and additional information.

When you click the **OK** button to launch the main application window as shown in [Figure 63](#), the SmartSnippets Wi-Fi IoT Power Profiler tool can be downloaded from the Renesas website (<https://www.renesas.com/us/en/products/wireless-connectivity/wi-fi/low-power-wi-fi>).

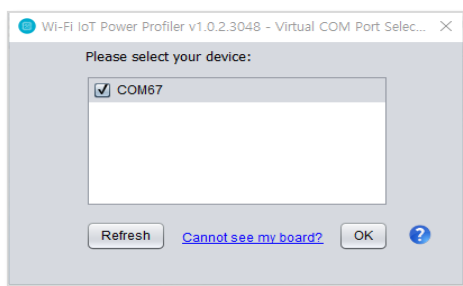

Figure 63. Select virtual COM port

### 6.4.2.3 Set Up Wi-Fi IoT Power Profiler

When the proper COM port is selected as shown in [Figure 63](#), click **OK**. Then, the main window of the Power Profiler application in SmartSnippets Wi-Fi IoT Power Profiler Toolbox pops up as shown in [Figure 64](#). Click the **Config** button at the bottom right and check that the configuration is correct. See [Figure 65](#).

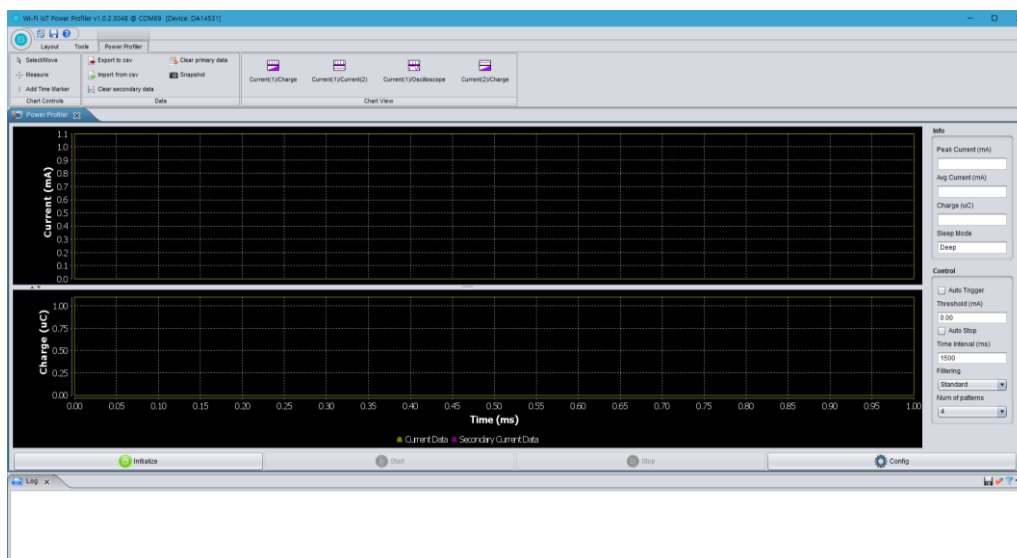

Figure 64. Power Profiler of SmartSnippets Toolbox

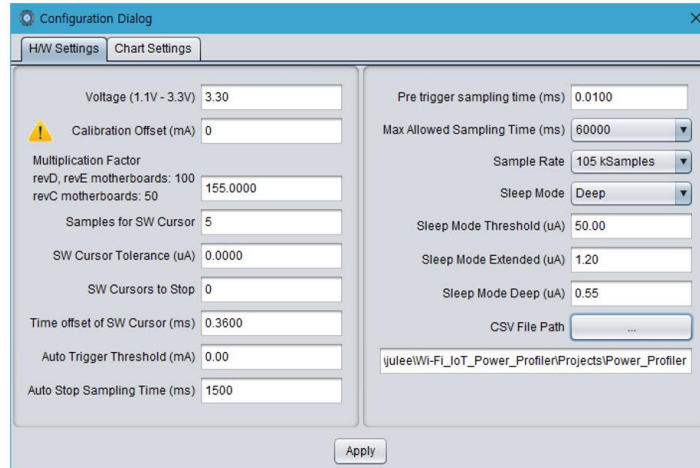

Figure 65. Power Profiler configuration

In the **H/W Settings** tab of the new profile, the **Voltage (1.1 V - 3.3 V)** field is typically empty and the **Calibration Offset (mA)** field is zero. Apply the correct voltage as configured in the Power Meter LDO (typically, it is 3.3 V). The **Calibration offset (mA)** is filled automatically with a calculated value. This value is good enough to measure with  $\pm 2\%$  accuracy. Check the multiplication factor, and for the DA16200/DA16600, it should be **155**.

You can set a maximum scale for the waveform window optionally since there are large peaks on wake-up from sleep (charging capacitors) generally. Thus, the useful part of the signal is compressed to a very small area. To set a maximum scale for the waveform window, open the **Chart Settings** tab as shown in Figure 66 and for **Plot Current1**, set the **MAX** scale of **Current (mA)** to 10 mA. Note that this does not affect anything to the accuracy of the measurement. It can only zoom the waveform, which is presented in the viewer. Click **Apply** and return to the measurement window.

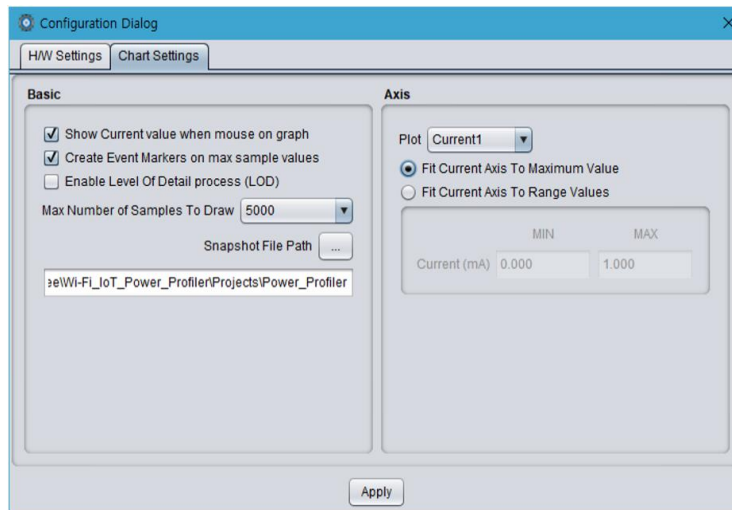

Figure 66. Power Profiler chart settings

#### 6.4.2.4 Measure Current Consumption

In the measurement window as shown in Figure 67, select **Initialize** at the bottom left (this step is only needed for the first communication with the A/D converter). Click **Start**.

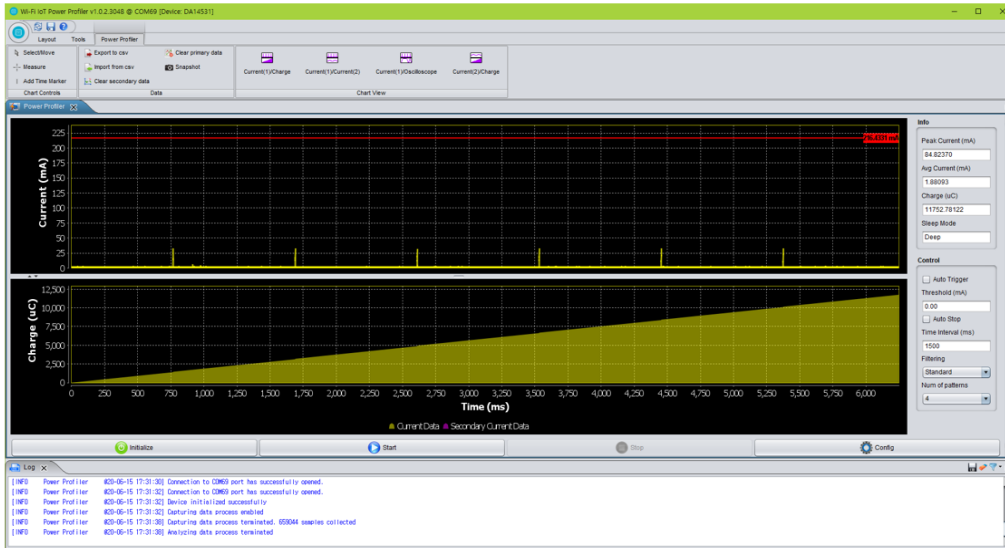

Figure 67. Free running capture

Select the **Power Profiler > Measure** menu on the window, you can measure the current consumption in the desired section as peak and average by using a mouse.

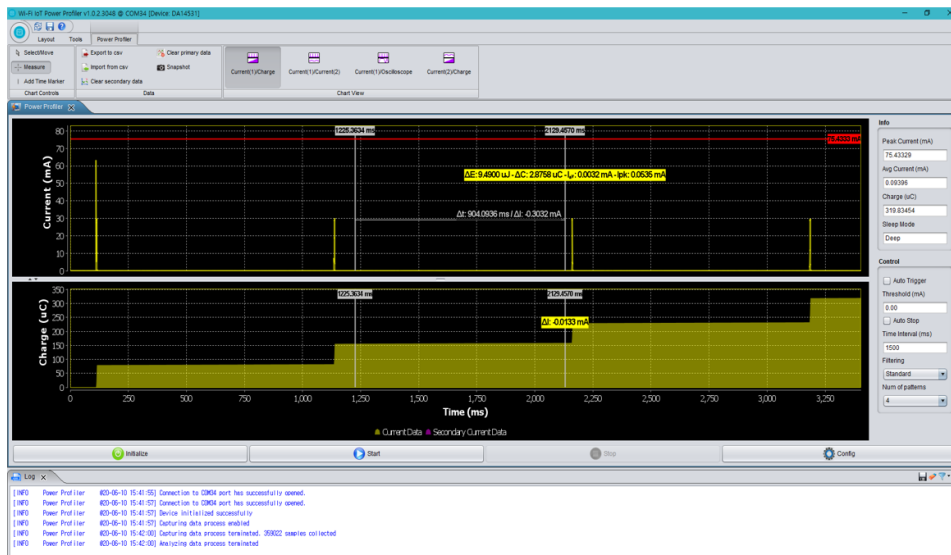

Figure 68. Measuring consumption by using chart controls

### 6.4.2.5 Manual Calibration

For the most accurate measurement, complete the following steps.

1. Remove the daughterboard, for example, the load, by physically disconnecting the DA16200/DA16600 EVB from the motherboard.
2. In the main window of the Power Profiler, click **Config** and temporarily set the **Calibration Offset (mA)** field to zero as shown in [Figure 69](#).

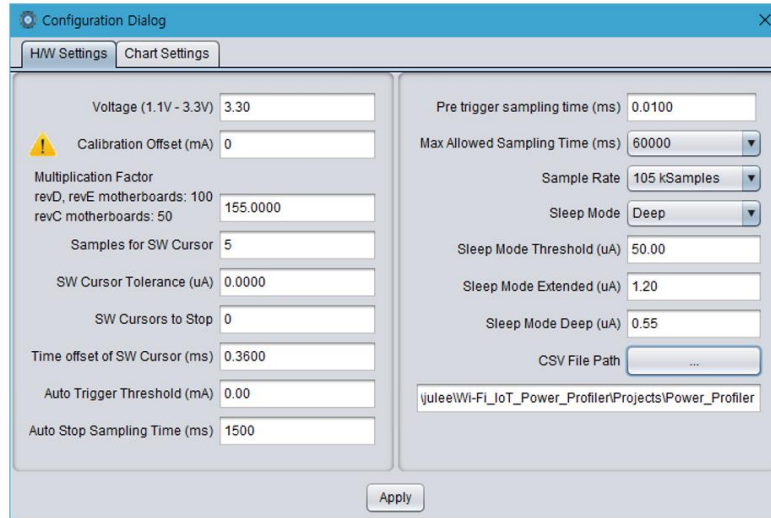

Figure 69. Setting offset to zero

- Run a free running capture for a few seconds and note down the number in the **Avg Current (mA)** field as shown in Figure 70. The last digits of the number keep changing slowly because of temperature drift. It is important to do the calibration steps periodically.
- Finally, put this average value with a negative sign in the **Calibration Offset (mA)** field. Ctrl+C and Ctrl+V are also workable as shown in Figure 70.

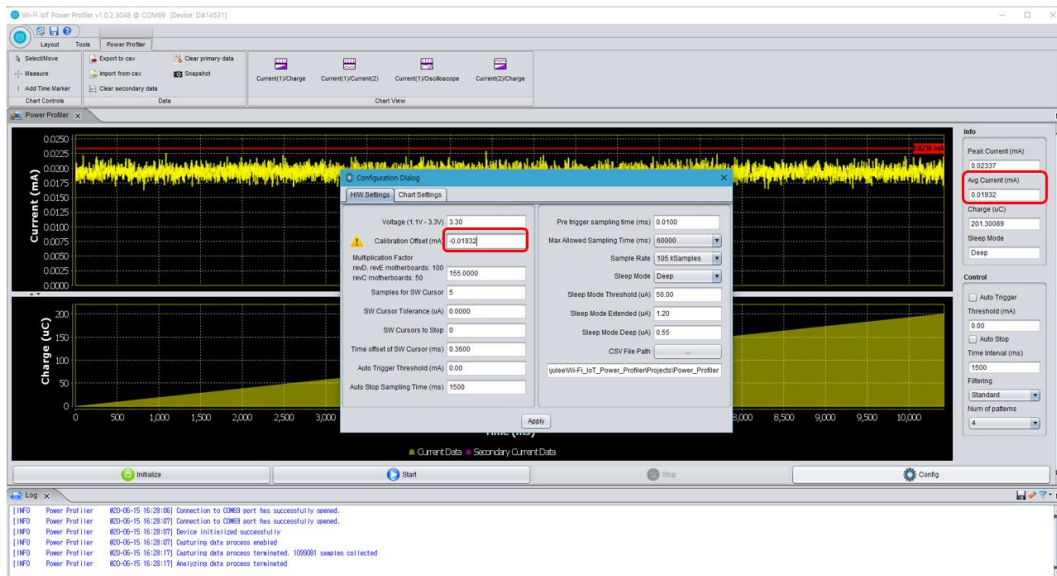

Figure 70. Setting calibration offset

You can find the user manual in the local folder where the DA16200 DA16600 Evaluation Kit Pro Power Profiler can be downloaded.

### 6.4.3 Measure Current in Sleep Mode 1

To measure current in Sleep mode 1, power off the EVB by setting **RTC\_PWR\_KEY** to the **OFF** position (**SW6** on the DA16200 EVB or **SW2** on the DA16600 EVB).

### 6.4.4 Measure Current in Sleep Mode 2

To measure current in Sleep mode 2, use the CLI commands:

- Power on the EVB by setting **RTC\_PWR\_KEY** to the **ON** position (**SW6** on the DA16200 EVB or **SW2** on the DA16600 EVB).
- Type the `factory` command to delete `nvr` data and certificates and perform software reboot.



- After the EVB reboots, run the `sys.hal` command to enter "hal" mode.
  - `[/DA16200] # sys.half`
- Run the `sleep 2 <time(sec)>` command to enter Sleep mode 2 for the specified time in seconds.
  - `[/DA16200/SYS.HAL] # sleep 2 <time(sec)>`

For instance, `[/DA16200/SYS.HAL] # sleep 2 10`

It allows the DA16200 to stay in Sleep mode 2 for a specified time (10 seconds) and wake up.

### 6.4.5 Measure Current in Sleep Mode 3

To measure current in Sleep mode 3, use the CLI commands:

- Power on the EVB by setting `RTC_PWR_KEY` to the **ON** position (**SW6** on the DA16200 EVB or **SW2** on the DA16600 EVB).
- Type the `factory` command to delete `nvrnm` data and certificates and perform software reboot.
- After the EVB reboots, run the `sys.hal` command to enter "hal" mode.
  - `[/DA16200] # sys.hal`
- Run the `sleep 3 <time(sec)>` command to enter Sleep mode 3 for the specified time in seconds.
  - `[/DA16200/SYS.HAL] # sleep 3 <time(sec)>`

For instance, `[/DA16200/SYS.HAL] # sleep 3 10`

It allows the DA16200 to stay in Sleep mode 3 for a specified time (10 s) and wake up.

### 6.4.6 Measure Current in DPM Low Power Mode

Enable DPM mode as described in Section 6.4.7.

- When running the DA16200 with DPM enabled, DA16200 runs `sleep 3` state, wake up for Beacon check, and Keep Alive according to the configured DTIM.

For example, [Figure 71](#) shows the current waveform with settings DTIM 10 (about 1 second at AP DTIM = 1) and Keep Alive 30 s. Sleep mode 3 means that it is in sleep state in the interval between RXs or between RX and TX.

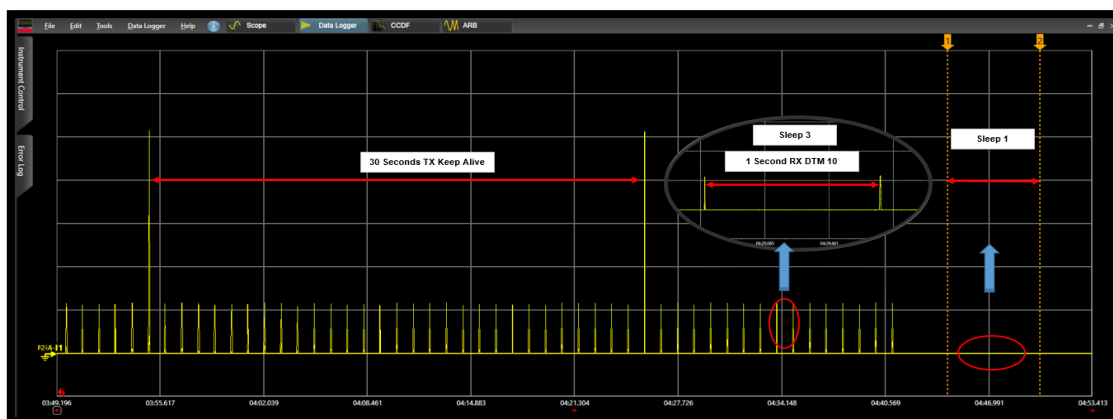

Figure 71. Measuring current in DPM low power mode

### 6.4.7 DPM Setup

Dynamic Power Management (DPM) is a synthesis of breakthrough in ultra-low-power technologies that enable extremely low-power operation in the DA16200. DPM shuts down all microelements on the DA16200/DA16600 when it is not in use, which allows a near zero level of power consumption when not actively transmitting or receiving data. Such low-power consumption can provide a battery life of one year or more, depending on the application. DPM also enables the ultra-low-power transmit/receive modes when the SoC needs to be awake to exchange information with other devices. Advanced algorithms allow it to stay asleep until the exact required moment to wake up to transmit or receive.

### 6.4.7.1 Enable DPM Mode

This section describes how to enable DPM low power mode.

1. Complete the following steps in Section 4.6 to set up the DA16200/DA16600 in station mode.
  - a. During the setup, enable DPM as follows:

```
Dialog DPM (Dynamic Power Management) ? [Yes/No/Quit] : y      Enter "y" to enable DPM.
DPM factors : Defaults ? [Yes/No/Quit] : y                    Enter "y" to accept defaults.
=====
DPM MODE              : Enable
Dynamic Period Set    : Disable
Keep Alive Time       : 30000 ms
User Wakeup Time      : 0 sec.
TIM Wakeup Count      : 10 dtim
=====
DPM CONFIGURATION CONFIRM ? [Yes/No/Quit] : y                Enter "y" to confirm the configuration.
Configuration OK
. done
```

**NOTE**

The default TIM wake-up count is 10 dtim:

$10 \text{ dtim} \times 102.4 = 1,024 \text{ ms} = 1 \text{ second} @ \text{DTIM} = 1$   
 (Assumed that AP DTIM = 3, 10 dtim is 921.6 ms)

Wake up from sleep takes place every second to check if a packet is received.

- b. Custom DPM factors can be defined during DPM setup as follows:

```
Dialog DPM (Dynamic Power Management) ? [Yes/No/Quit] : y      Enter "y" to enable DPM.
DPM factors : Defaults ? [Yes/No/Quit] : n                    Enter "n" to provide custom DPM factors.
DDPS Enable ? [No/Yes/Quit] (Default: No) :                  Enter to accept the default of DDPS disabled.
DPM Keep Alive Time(0~600000 ms) ? [Quit] (Default 30000 ms) :
                                                                Custom value or "enter" for default.
DPM User Wakeup Time(0~86400 Sec.) ? [Quit] (Default 0 Sec.) :
                                                                Custom value or "enter" for default.
DPM TIM Wakeup Count(1~65535 dtim) ? [Quit] (Default 10) :   Custom value or "enter" for default.
=====
DPM MODE              : Enable
Dynamic Period Set    : Disable
Keep Alive Time       : 30000 ms
User Wakeup Time      : 0 sec.
TIM Wakeup Count      : 10 dtim
=====
DPM CONFIGURATION CONFIRM ? [Yes/No/Quit] : y                Enter "y" to confirm DPM factors.
Configuration OK
. done
```

2. After rebooting, the DA16200/DA16600 enters DPM low power mode. The following message is displayed:

```

Connection COMPLETE to 80:ca:4b:30:02:0a
-- DHCP Client WLAN0: SEL(6)
-- DHCP Client WLAN0: REQ(1)
-- DHCP Client WLAN0: CHK(8)
-- DHCP Client WLAN0: BOUND(10)
    Assigned addr   : 192.168.219.105
        netmask    : 255.255.255.0
        gateway    : 192.168.219.1
        DNS addr   : 61.41.153.2
    DHCP Server IP  : 192.168.219.1
    Lease Time     : 06h 00m 00s
    Renewal Time   : 05h 00m 00s
    
```

**NOTE**  
 When the DA16200/DA16600 is in DPM low power mode, user input is not accepted by the debug terminal. To reenale user input, see Section 6.4.7.2.

### 6.4.7.2 Hold/Disable DPM Mode

When the DA16200/DA16600 is in DPM low power mode, user input is not accepted by the debug terminal. This is because the UART interfaces are powered down during DPM low power mode.

To exit this state and start over with `setup`, complete the following steps.

1. Copy the string `dpm hold` to the clipboard.  
 For example, open Notepad, type `dpm hold`, and then copy the command string.
2. To power off (move to OFF position), use `RTC_PWR_KEY`.
3. To power on (move to ON position), use `RTC_PWR_KEY`.
4. Before the message `">>> Start DPM Power-Down !!!"` is printed on the console, paste the `dpm hold` string in the terminal window and immediately click the **ENTER** key.
  - For Windows Tera Term, use ALT-R or right click the window to paste the string.
  - For Linux minicom, use CTRL-V or right click the window to paste the string.
 When this procedure is completed successfully, the message `"- DPM Sleep Manager HOLD.."` is displayed.  
 If it is not working, try again.

```

*****
*
*           DA16200 SDK Information
* -----
*
* - CPU Type       : Cortex-M4 (120 MHz)
* - OS Type       : FreeRTOS 10.4.3
* - Serial Flash  : 4 MB
* - SDK Version   : V3.1.3.0 GEN
* - F/W Version   : FRTOS-GEN01-01-15129-000000
* - F/W Build Time : Aug 26 2021 22:58:01
* - Boot Index    : 0
*
*****
    
```

```

System Mode : Station Only (0)
>>> DA16x Supp Ver2.7 - 2020_07
>>> Wi-Fi mode : b/g/n -> b/g (for DPM)
>>> MAC address (sta0) : d4:3d:39:10:a2:48
>>> sta0 interface add OK
>>> Start STA mode...
dpm hold
- DPM Sleep Manager HOLD ...
>>> Network Interface (wlan0) : UP
>>> Associated with 80:ca:4b:30:02:0a
Connection COMPLETE to 80:ca:4b:30:02:0a
-- DHCP Client WLAN0: SEL(6)
-- DHCP Client WLAN0: REQ(1)
-- DHCP Client WLAN0: CHK(8)
-- DHCP Client WLAN0: BOUND(10)
    Assigned addr   : 192.168.219.105
        netmask     : 255.255.255.0
        gateway     : 192.168.219.1
        DNS addr    : 61.41.153.2
    DHCP Server IP  : 192.168.219.1
    Lease Time      : 06h 00m 00s
    Renewal Time    : 05h 00m 00s
[/DA16200] #

```

5. Check the DPM Hold command is successfully applied, click Enter to verify if the DA16200/DA16600 is not in sleep mode.
6. Run the `dpm off` command in the prompt to disable the DPM mode, then the DA16200/DA16600 reboots, and the command prompt is available again.

```

[/DA16200] # dpm off
Wakeup source is 0x1
[dpm_init_retnemory] DPM INIT CONFIGURATION(1)
*****
*           DA16200 SDK Information
* -----
*
* - CPU Type       : Cortex-M4 (120 MHz)
* - OS Type        : FreeRTOS 10.4.3
* - Serial Flash   : 4 MB
* - SDK Version    : V3.1.3.0 GEN
* - F/W Version    : FRTOS-GEN01-01-15129-000000
* - F/W Build Time : Aug 26 2021 22:58:01
* - Boot Index     : 0
*
*****

```

```
System Mode : Station Only (0)
>>> DA16x Supp Ver2.7 - 2020_07
>>> MAC address (sta0) : d4:3d:39:10:a2:48
>>> sta0 interface add OK
>>> Start STA mode...
>>> Network Interface (wlan0) : UP
>>> Associated with 80:ca:4b:30:02:0a
Connection COMPLETE to 80:ca:4b:30:02:0a
-- DHCP Client WLAN0: SEL(6)
-- DHCP Client WLAN0: REQ(1)
-- DHCP Client WLAN0: CHK(8)
-- DHCP Client WLAN0: BOUND(10)
    Assigned addr   : 192.168.219.105
        netmask     : 255.255.255.0
        gateway     : 192.168.219.1
        DNS addr    : 61.41.153.2
    DHCP Server IP  : 192.168.219.1
    Lease Time      : 06h 00m 00s
    Renewal Time    : 03h 00m 00s

[/DA16200] #
```

### NOTE

The `dpm hold` command should be used to check the status of DPM operation in the console. After entering DPM hold state, it is not allowed to perform normal operations except for debugging purposes.

## Appendix A Old Versions of EVB

### A.1 DA16200 EVB V10.0

Figure 72 shows the hardware configuration of the DA16200 EVB.

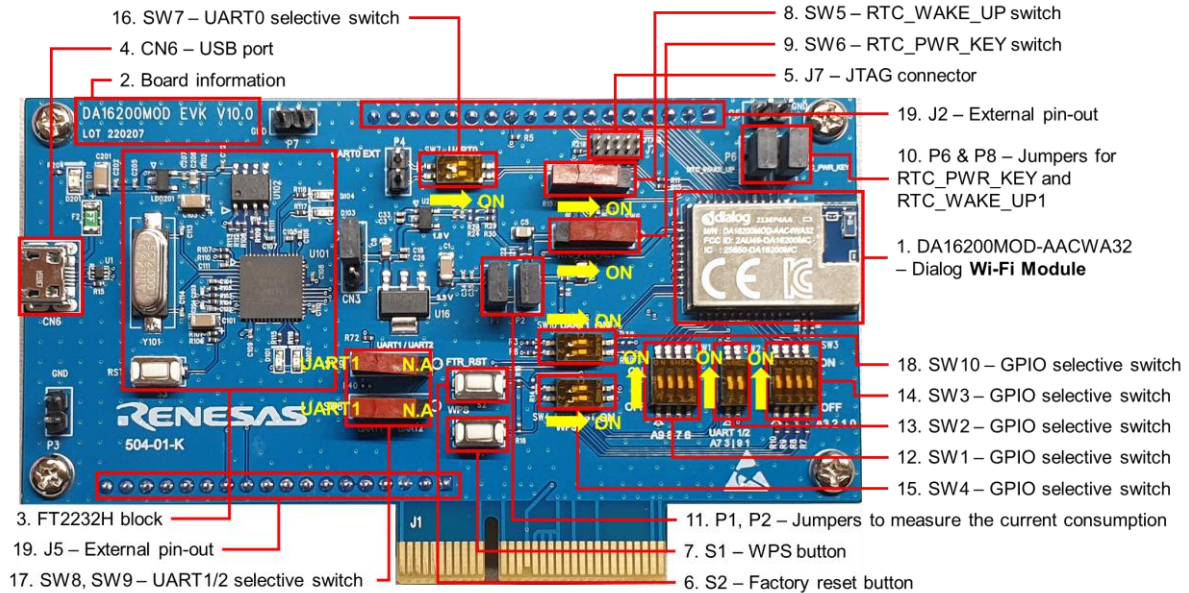

Figure 72. DA16200 EVB hardware configuration

The DA16200 EVB V10.0 has the following components:

Table 17. Components on DA16200 EVB

No	Name	Description
1	DA16200MOD-AACWA32	Renesas Wi-Fi module.
2	Board Information	Board version and manufacturing date.
3	FH2232H Block	USB to UART/SPI interfaces.
4	CN6 – USB Port	Provide UART0 for debug and UART1/2 for test and SPI.
5	J7 – JTAG Connector	Connector for the JTAG Debugger. (Note 1)
6	S2 – Factory Reset Button	Factory Reset button using GPIOA_7. To enable this button, set Pin 2 of SW4 to ON. Press the button for at least 5 sf to delete <code>nvram</code> data and certificates and perform software reboot, which should be rebooted in concurrent mode by default.
7	S1 – WPS Button	WPS button using GPIOA_6. To enable this button, set Pin 1 of SW4 to ON and press the button to start WPS mode.
8	SW5 – RTC_WAKE_UP Switch	Switch to wake up the board from Sleep mode.
9	SW6 – RTC_PWR_KEY Switch	Switch to turn the EVB ON and OFF.

Figure 73. J7 – JTAG Connector

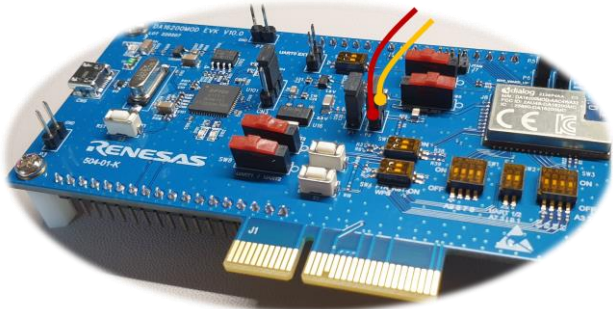
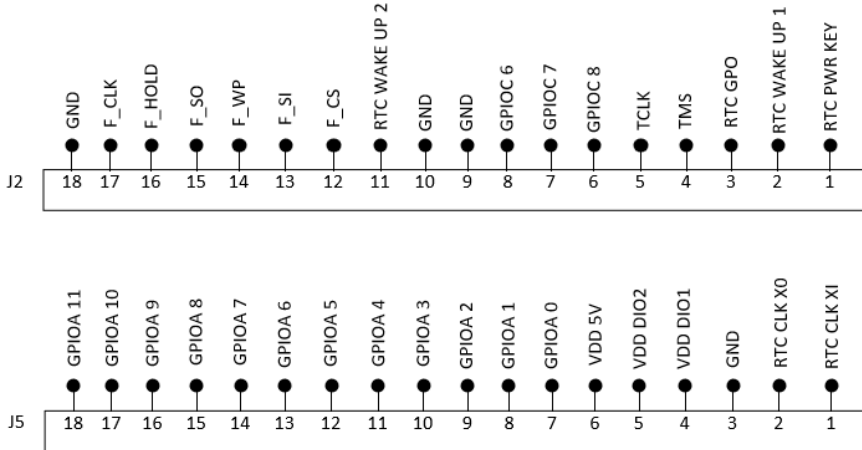
No	Name	Description
10	P6 – Jumpers for RTC_WAKE_UP1	Pin for connecting the external control signal with MCU. For normal operation, this jumper should be shorted.
	P8 – Jumpers for RTC_PWR_KEY	Pin for connecting the external control signal with MCU. For normal operation, this jumper should be shorted.
11	P1 – External VDD	External VDD (3.3 V) can be supplied to the P1 pins. For normal operation, this jumper should be shorted.
	P2 – Jumper to Measure Current Consumption of the DA16200	Pin for current measurement. For normal operation, this pin should be shorted. <ul style="list-style-type: none"> <li>▪ Pull out the Short Pin cap and use jumper wires to connect to the measuring equipment.</li> </ul>
		
<p><b>Figure 74. Jumper to measure current consumption of the DA16200</b></p>		
12	SW1 – GPIO Selection Switch	GPIO selection switch, default OFF. See <a href="#">Table 18</a> .
13	SW2 – GPIO Selection Switch	GPIO selection switch, default ON. See <a href="#">Table 18</a> .
14	SW3 – GPIO Selection Switch	GPIO selection switch, default OFF. See <a href="#">Table 18</a> .
15	SW4 – GPIO Selection Switch	GPIO selection switch, default ON. See <a href="#">Table 18</a> .
16	SW7 – UART0 Selection Switch	UART0 selection switch, default ON. See <a href="#">Table 18</a> .
17	SW8, SW9 – UART1/2 Selection Switch	UART1/2 selection switch, default LEFT (UART1).
18	SW10 – GPIO Selection Switch	GPIO selection switch, default ON. See <a href="#">Table 18</a> .
19	J2, J5 – External Pinout	<div style="text-align: center;">  </div>
<p><b>Figure 75. J2, J5 – external pinout</b></p>		

**Note 1** The pin 7 of the I-jet debugger cable is keyed with a white plug so the pin 7 must be removed from the EVB.



Table 18. DA16200 EVB switch description

Switch	Pin	Relevant GPIO	ON	OFF	Default
SW1	1	GPIOA6	Connect FT2232H to SPI_CSB (Note 1)	WPS	OFF
	2	GPIOA7	Connect FT2232H to SPI_CLK (Note 1)	Factory reset	
	3	GPIOA8	Connect FT2232H to SPI_MISO (Note 1)	External pinout (J2/J5) only	
	4	GPIOA9	Connect FT2232H to SPI_MOSI (Note 1)		
SW2	1	GPIOA4	Connect FT2232H to UART1_TXD	External pinout (J2/J5) only	ON
	2	GPIOA5	Connect FT2232H to UART1_RXD		
SW3	1	GPIOA0	Connect FT2232H to SPI_CSB (Note 1)	External pinout (J2/J5) only	OFF
	2	GPIOA1	Connect FT2232H to SPI_CLK (Note 1)		
	3	GPIOA2	Connect FT2232H to SPI_MISO (Note 1)		
	4	GPIOA3	Connect FT2232H to SPI_MOSI (Note 1)		
SW4	1	GPIOA6	WPS	External pinout (J2/J5) only	ON
	2	GPIOA7	Factory reset		
SW7	1	UART0_TXD	Connect FT232H to UART0_TXD	NC	ON
	2	UART0_RXD	Connect FT232H to UART0_RXD		
SW8	-	GPIOA4	Not available on DA16200 EVB V10.0 (Right)	Connect SW2 to SW10 (Left)	LEFT
SW9	-	GPIOA5	Not available on DA16200 EVB V10.0 (Right)	Connect SW2 to SW10 (Left)	LEFT
SW10	1	GPIOA4	Connect SW8 to UART1_TXD	External pinout (J2/J5) only	ON
	2	GPIOA5	Connect SW9 to UART1_RXD		

**Note 1** By default, the SPI interface is configured to support firmware download through the FT2232H. See Section 4.7 for details on how to configure the EVB to support AT command processing from an MCU directly connected to the SPI interface.

The current consumption can be measured on the P2 jumper with current measuring equipment. For details on how to set up the test, see Section 6.4. When the DA16200 EVK Pro is used for measuring current consumption, the P1 jumper should be removed. For more information on the DA16200 EVK Pro, see Section 6.4.2 and Ref. [9].



## A.2 DA16200 EVB V9.0

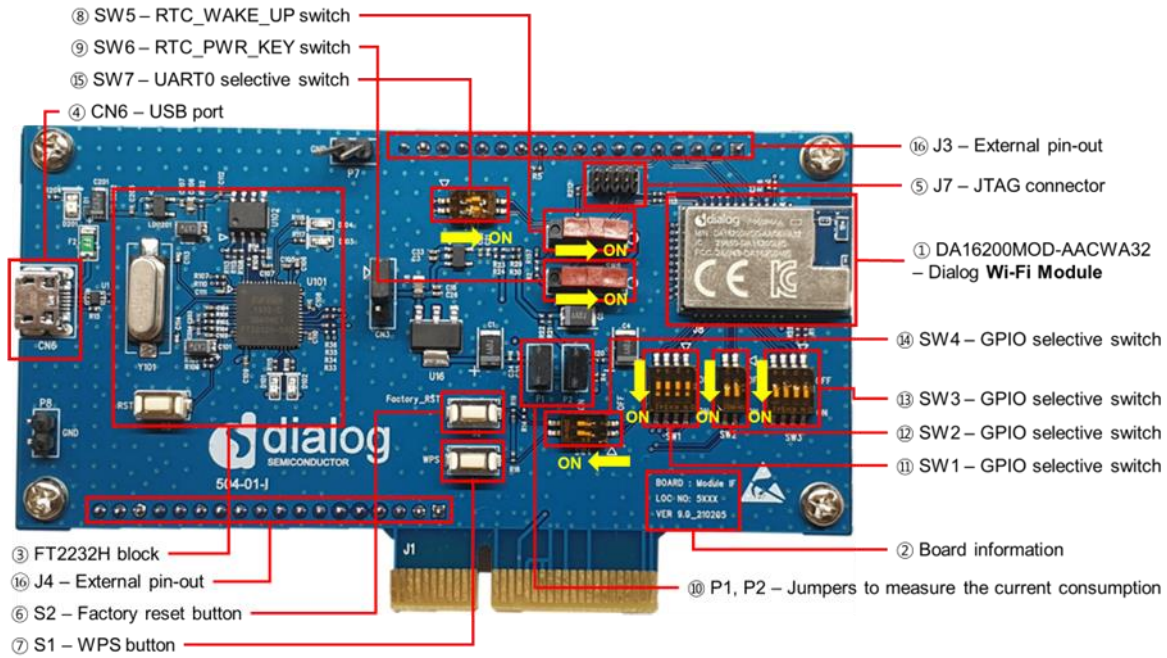
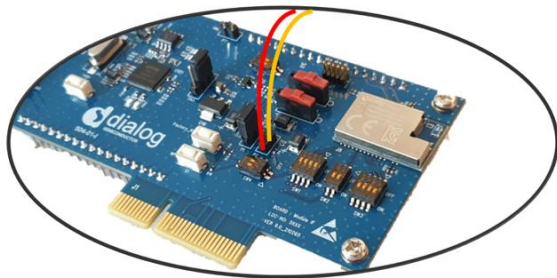
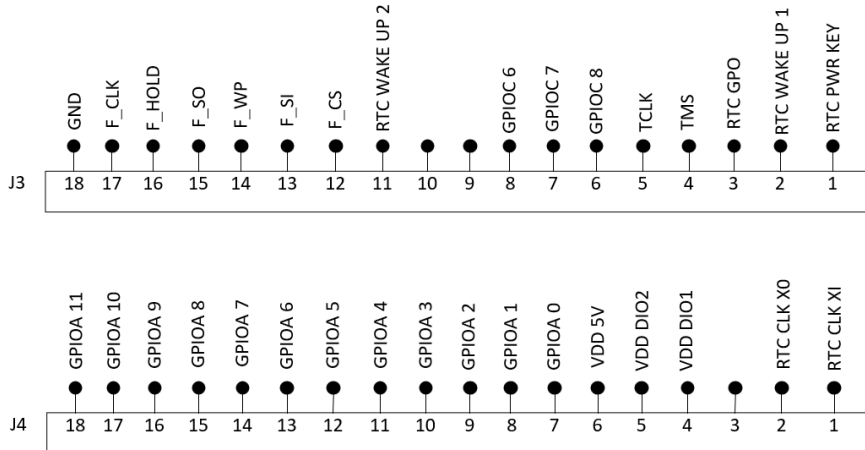

Figure 76. DA16200 EVB V9.0 hardware configuration

The DA16200 EVB V9.0 has the following components:

Table 19. Components on DA16200 EVB

No	Name	Description
1	DA16200MOD-AACWA32	Renesas Wi-Fi Module.
2	Board Information	Board version and manufacturing date.
3	FH2232H Block	USB to UART/SPI interfaces.
4	CN6 – USB Port	Provide UART0 for debug and UART1/2 for test and SPI.
5	J7 – JTAG Connector	Connector for the JTAG Debugger. (Note 1)
6	S2 – Factory Reset Button	Factory Reset button using GPIOA_7. To enable this button, set Pin 2 of SW4 to ON. Press the button for at least 5 s to delete <code>nvr</code> data and certificates and perform software reboot, which should be rebooted in concurrent mode by default.
7	S1 – WPS Button	WPS button using GPIOA6. To enable this button, set Pin 1 of SW4 to ON and press the button to start WPS mode.
8	SW5 – RTC_WAKE_UP Switch	Switch to wake up the board from Sleep mode.
9	SW6 – RTC_PWR_KEY Switch	Switch to turn the EVB ON and OFF.
10	P1 – External VDD	External VDD (3.3 V) can be supplied to the P1 pins. For normal operation, this jumper should be shorted.

No	Name	Description
10	P2 – Jumper to Measure Current Consumption of the DA16200	<p>Pin for current measurement.</p> <ul style="list-style-type: none"> <li>▪ For normal operation, this pin should be shorted.                             <ul style="list-style-type: none"> <li>• Pull out the Short Pin cap and use jumper wires to connect to the measuring equipment.</li> </ul> </li> </ul>  <p style="text-align: center;"><b>Figure 78. P2 – Jumper to Measure Current Consumption of the DA16200</b></p>
11	SW1 – GPIO Selection Switch	GPIO selection switch, default OFF. See <a href="#">Table 20</a> .
12	SW2 – GPIO Selection Switch	GPIO selection switch, default ON. See <a href="#">Table 20</a> .
13	SW3 – GPIO Selection Switch	GPIO selection switch, default ON. See <a href="#">Table 20</a> .
14	SW4 – GPIO Selection Switch	GPIO selection switch, default ON. See <a href="#">Table 20</a> .
15	SW7 – UART0 Selection Switch	UART0 selection switch, default ON. See <a href="#">Table 20</a> .
16	J3, J4 – External Connector	 <p style="text-align: center;"><b>Figure 79. J3, J4 – external connector</b></p>

**Note 1** The pin 7 of the I-jet debugger cable is keyed with a white plug so the pin 7 must be removed from the EVB.

**Table 20. GPIO and SPI selection switch**

Switch	Pin	Relevant GPIO	On	Off
SW1	1	GPIOA6	Connect FT2232H to SPI_CSB	WPS
	2	GPIOA7	Connect FT2232H to SPI_CLK	Factory reset
	3	GPIOA8	Connect FT2232H to SPI_MISO	Ext Con (J3/J4) only
	4	GPIOA9	Connect FT2232H to SPI_MOSI	Ext Con (J3/J4) only
SW2	1	GPIOA4	Connect FT2232H to UART1_TXD	Ext Con (J3/J4) only
	2	GPIOA5	Connect FT2232H to UART1_RXD	Ext Con (J3/J4) only
SW3	1	GPIOA0	Connect FT2232H to SPI_CSB	Ext Con (J3/J4) only

Switch	Pin	Relevant GPIO	On	Off
	2	GPIOA1	Connect FT2232H to SPI_CLK	Ext Con (J3/J4) only
	3	GPIOA2	Connect FT2232H to SPI_MISO	Ext Con (J3/J4) only
	4	GPIOA3	Connect FT2232H to SPI_MOSI	Ext Con (J3/J4) only
SW4	1	GPIOA6	WPS	Ext Con (J3/J4) only
	2	GPIOA7	Factory reset	Ext Con (J3/J4) only
SW7	1	UART0_TXD	Connect FT232H to UART0_TXD	NC
	2	UART0_RXD	Connect FT232H to UART0_RXD	NC

The current consumption can be measured on the jumper P2 with current measuring equipment. For details on how to set up the test, see Section 6.4. When the DA16200 EVK Pro Board is used for measuring current consumption, the P1 jumper must be removed. For more details on the DA16200 EVB, see Ref. [9].

### A.3 DA16600 EVB V5.0

Figure 80 shows the hardware configuration of the DA16600 EVB.

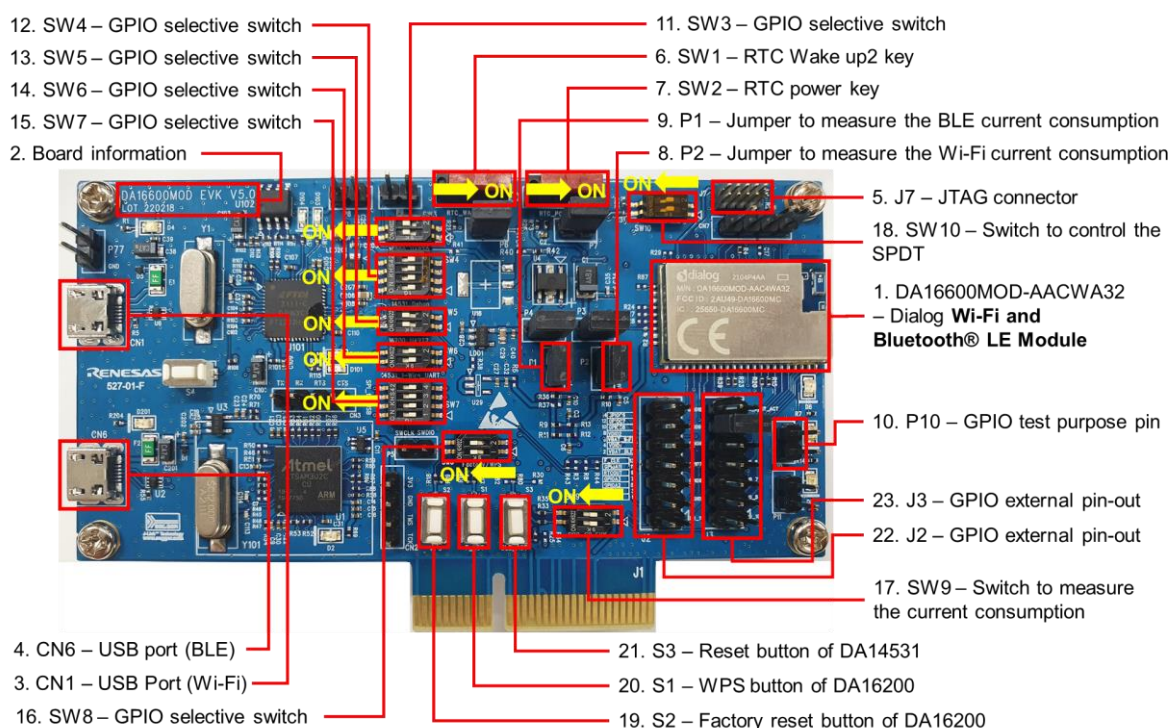
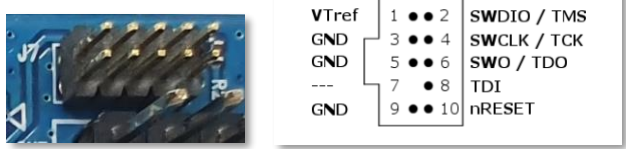

Figure 80. DA16600 EVB hardware configuration

DA16600 EVB has the following components:

Table 21. Components on DA16600 EVB

No	Name	Description
1	DA16600MOD-AACWA32	Renesas Wi-Fi and Bluetooth® LE Module.
2	Board Information	Board version and manufacturing date.
3	CN1 - USB Port (Wi-Fi)	Provide UART0 for debug and UART1 for test.
4	CN6 - USB Port (Bluetooth)	Connect directly to DA14531 for debugging only. (Note 2)
5	J7 - JTAG Connector	Connector for IARs I-jet JTAG Debugger. (Note 1)

No	Name	Description
		 <p style="text-align: center;"><b>Figure 81. J7 – JTAG Connector</b></p>
6	SW1 – RTC Wake Up2 Key	Switch to wake up the board from Sleep mode.
7	SW2 – RTC Power Key	Switch to turn the EVB on and off.
8	P2 – Jumper to Measure Current Consumption of DA16200	Jumper to measure current used by the Wi-Fi device. For normal operation, this jumper must be shorted.
9	P1 – Jumper to Measure Current Consumption of DA14531	Jumper to measure current used by the Bluetooth® LE device. For normal operation, this jumper must be shorted.
10	P10 – Jumper to Test GPIO	GPIO test pin. Add jumpers from J2/J3 to P10 to control the two LEDs using GPIOs.
11	SW3 – GPIO Selective Switch	GPIO selection switch, default ON. See <a href="#">Table 22</a> .
12	SW4 – GPIO Selective Switch	GPIO selection switch, default OFF. See <a href="#">Table 22</a> .
13	SW5 – GPIO Selective Switch	GPIO selection switch, default ON. See <a href="#">Table 22</a> .
14	SW6 – GPIO Selective Switch	GPIO selection switch, default OFF. See <a href="#">Table 22</a> .
15	SW7 – GPIO Selective Switch	GPIO selection switch, default OFF. See <a href="#">Table 22</a> .
16	SW8 – GPIO Selective Switch	GPIO selection switch, default ON. See <a href="#">Table 22</a> .
17	SW9 – Switch to Test Current Consumption	Switch to test current consumption using a Pro board kit, default OFF.
18	SW10 – Switch to Control the SPDT	Switch to control RF switch of DA16600MOD in test mode, default OFF.
19	S2 – Factory Reset Button	Factory Reset button using GPIOA_7. To enable this button, set Pin 2 of SW4 to ON. Press the button for at least 5 s to delete <i>nvr</i> am data and certificates and perform software reboot, which should be rebooted in concurrent mode by default.
20	S1 – WPS Button	WPS button using GPIOA6. To enable this button, set Pin 1 of SW7 to ON and press the button to start WPS mode.
21	S3 – DA14351 Reset Button	Reset button of DA14531 in test mode.

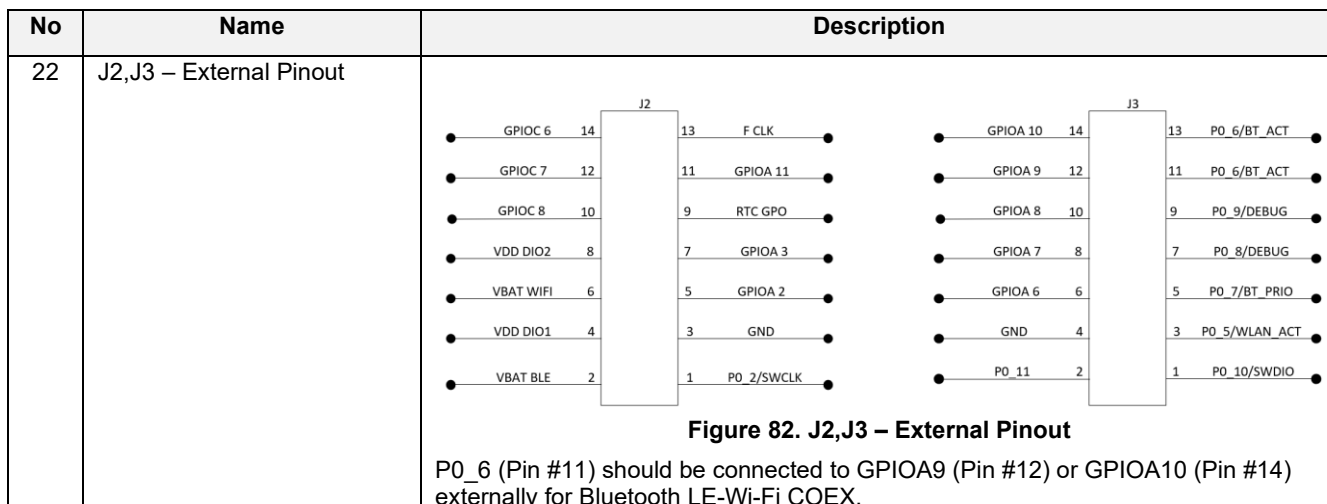

**Note 1** The pin 7 on the I-jet debugger cable is keyed with a white plug so the pin 7 must be removed from the EVB.

**Note 2** Do not use this port during normal operation.

The DA16600 EVB includes several switches, see descriptions for each switch in [Table 22](#).

**Table 22. DA16600 EVB switch description**

Switch	Pin	Relevant pin	ON	OFF	Default	
SW3	1	DA16200 UART0_RXD	Connect FT232H to UART0_RXD	NC	ON	
	2	UART0_TXD	Connect FT232H to UART0_TXD			
SW4	1	DA14531 P0_8	Connect FT2232H to P0_8 (UART_RXD)	External pinout (J2/J3) only	OFF	
	2		Connect FT2232H to P0_9 (UART_TXD)			
	3		Enable Keil toolchain debug of DA14531 (SWCLK)			
	4		Enable Keil toolchain debug of DA14531 (SWDIO)			
SW5	1	DA16200 GPIOC6	Connect FT2232H to UART2_TXD	External pinout (J2/J3) only	ON	
	2	GPIOC7	Connect FT2232H to UART2_RXD			
SW6	1	DA14531 P0_5	Connect FT2232H to P0_5 (1-wire UART)	External pinout (J2/J3) only	OFF	
	2		Connect FT2232H to P0_5 (1-wire UART)			
SW7	1	DA16200 GPIOA6	Not available on DA16600 EVB V5.0	External pinout (J2/J3) only	OFF	
	2					GPIOA7
	3					GPIOA8
	4					GPIOA9
SW8	1	DA16200 GPIOA6	WPS	External pinout (J2/J3) only	ON	
	2	GPIOA7	Factory reset			
SW9	1	DA16200 Measuring current consumption	Enable to measure current consumption of DA16200 with EVK Pro. Need to remove jumper P2	Normal operation/ Need to connect P2	OFF	
	2	DA14531 Measuring current consumption	Enable to measure current consumption of DA14531 with EVK Pro. Need to remove jumper P1			



Switch	Pin	Relevant pin	ON	OFF	Default
				connect P1	
SW10	1	DA14531	P0_6	Manual control of the internal RF SPDT. Pin 1 OFF & Pin 2 OFF: Internally controlled Pin 1 ON & Pin 2 OFF: DA14531 RF path ON Pin 1 OFF & Pin 2 ON: DA16200 RF path ON	
	2				

The current consumption can be measured on the jumpers P1 and P2 with current measuring equipment. See Section 6.4 for details on the test setup. When DA16600 EVK Pro is used for measuring current consumption, remove jumpers P1 and P2 and set pins 1 and 2 of SW9 to the ON position.

To measure the current consumption of DA16200, remove the jumper on P2 and turn ON pin 1 of SW9. To measure the current consumption of DA14531, remove the jumper on P1 and turn ON pin 2 of SW9. The current consumption of the DA16200 and the DA14531 can be measured simultaneously. For more information on the DA16600 EVB, see Ref. [10].

### A.4 DA16600 EVB V4.0

Figure 83 shows the hardware configuration of the DA16600 EVB.

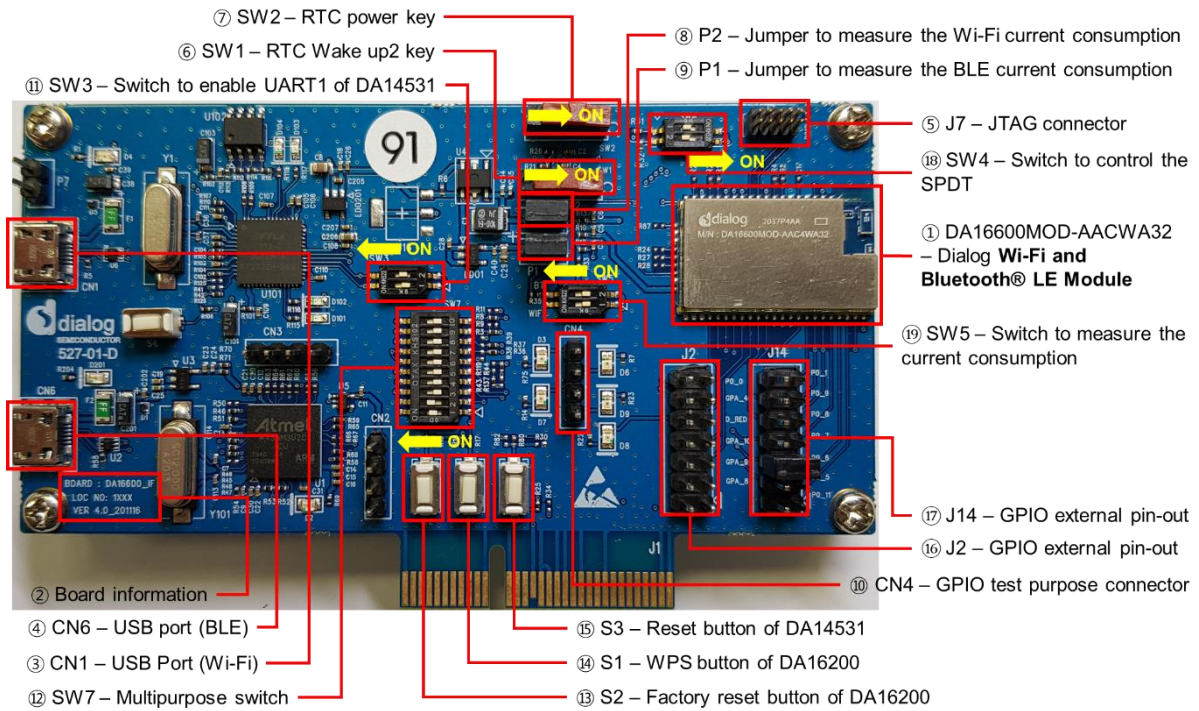

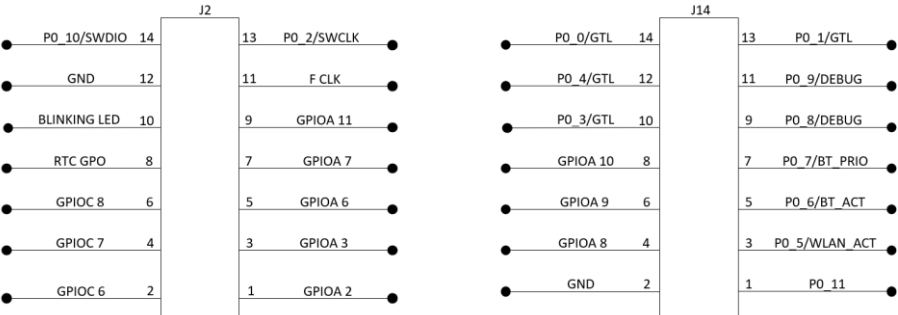

Figure 83. DA16600 EVB V4.0 hardware configuration

The DA16600 EVB V4.0 has the following components:

Table 23. Components on DA16600 EVB

ID	Name	Description
1	DA16600MOD-AACWA32	Renesas Wi-Fi and Bluetooth® LE Module.
2	Board Information	Board version and manufacturing date.
3	CN1 - USB Port (Wi-Fi)	Provide UART0 for debug and UART1 for test.
4	CN6 - USB Port (Bluetooth)	Connect directly to DA14531 for debugging only. (Note 1)
5	J7 - JTAG Connector	Connector for IARs I-jet JTAG Debugger. (Note 2)

ID	Name	Description															
		 <table border="1" data-bbox="933 302 1284 459"> <tr> <td>VTref</td> <td>1 ●● 2</td> <td>SWDIO / TMS</td> </tr> <tr> <td>GND</td> <td>3 ●● 4</td> <td>SWCLK / TCK</td> </tr> <tr> <td>GND</td> <td>5 ●● 6</td> <td>SWO / TDO</td> </tr> <tr> <td>---</td> <td>7 ●● 8</td> <td>TDI</td> </tr> <tr> <td>GND</td> <td>9 ●● 10</td> <td>nRESET</td> </tr> </table> <p style="text-align: center;"><b>Figure 84. J7 - JTAG Connector</b></p>	VTref	1 ●● 2	SWDIO / TMS	GND	3 ●● 4	SWCLK / TCK	GND	5 ●● 6	SWO / TDO	---	7 ●● 8	TDI	GND	9 ●● 10	nRESET
VTref	1 ●● 2	SWDIO / TMS															
GND	3 ●● 4	SWCLK / TCK															
GND	5 ●● 6	SWO / TDO															
---	7 ●● 8	TDI															
GND	9 ●● 10	nRESET															
6	SW1 - RTC Wake Up2 Key	Switch to wake up the board from Sleep mode.															
7	SW2 - RTC Power Key	Switch to turn the EVB on and off.															
8	P2 – Jumper	Jumper to measure current used by the Wi-Fi device (DA16200). For normal operation, this jumper must be shorted.															
9	P1 - Jumper	Jumper to measure current used by the Bluetooth® LE device (DA16600). For normal operation, this jumper must be shorted.															
10	CN4 - Connector	GPIO test connector. Add jumpers from J2/J4 to CN4 to control the four LEDs using GPIOs.															
11	SW3 - Switch	Switch to connect directly to DA14531 and use UART to check Bluetooth® LE performance. Set this switch to off for normal operation.															
12	SW7 - Switch	Multipurpose switch. Set this switch to off for normal operation.															
13	S2 – Factory Reset Button	Factory Reset button of DA16200 using GPIO_7. To enable this button, set Pin 2 of SW7 to On.															
14	S1 – WPS Button	WPS button of DA16200 using GPIO_6. To enable this button, set Pin 1 of SW7 to On.															
15	S3 – DA14351 Reset Button	Reset button of DA14531 in test mode.															
16	J2,14 - Connector	 <p style="text-align: center;"><b>Figure 85. J2,14 - Connector</b></p>															
17	SW4 – Switch	Switch to control RF switch of DA16600MOD in test mode.															
18	SW5 - Switch	Switch to check current consumption using a power meter kit.															

**Note 1** Do not use this port during normal operation.

**Note 2** The pin 7 on the I-jet debugger cable is keyed with a white plug so the pin 7 must be removed from the EVB. The DA16600MOD EVB includes several switches, see descriptions for each switch in [Table 24](#).

**Table 24. Description of switches**

Switch	Pin	Description	Relevant pin		Default
SW7	1	Connect WPS button S1 to GPIOA6	DA16200	GPIOA6	ON
	2	Connect Factory Reset button S2 to GPIOA7	DA16200	GPIOA7	ON

Switch	Pin	Description	Relevant pin		Default
	3	Enable Keil toolchain debug of DA14531 (SWCLK)	DA14531	P0_2/SWCLK	OFF
	4	Enable Keil toolchain debug of DA14531 (SWDIO)	DA14531	P0_10/SWDIO	OFF
	5	Enable UART debug of DA14531 (UART2 RX)	DA14531	P0_8/DEBUG	OFF
	6	Enable UART debug of DA14531 (UART2 TX)	DA14531	P0_9/DEBUG	OFF
	7	Not used			OFF
	8	Not used			OFF
	9	Not used			OFF
	10	Not used			OFF
SW3	1	Enable UART1 of DA14531 (1-wire UART)	DA14531	P0_5/WLAN_ACT	OFF
	2	Enable UART1 of DA14531 (1-wire UART)	DA14531	P0_5/WLAN_ACT	OFF
SW4	1	Manual control of the internal RF SPDT. Pin 1 OFF and Pin 2 OFF: internally controlled. Pin 1 ON and Pin 2 OFF: DA14531 RF path ON Pin 1 OFF and Pin 2 ON: DA16200 RF path ON	DA14531	P0_6/BT_ACT	OFF
	2				OFF
SW5	1	Measure current consumption of DA16200 with DA16600 EVK Pro			OFF
	2	Measure current consumption of DA14531 with DA16600 EVK Pro			OFF

The current consumption can be measured on the jumpers P1 and P2 with current measuring equipment. See Section 6.4 for details on the test setup. When DA16600 EVK Pro is used for measuring current consumption, remove jumpers P1 and P2 and set pins 1 and 2 of SW5 to the ON position.

To measure the current consumption of the DA16200, remove the jumper on P2 and turn ON pin 1 of SW5. To measure the current consumption of DA14531, remove the jumper on P1 and turn ON pin 2 of SW5. The current consumption of the DA16200 and the DA14531 can be measured simultaneously. For more details on the DA16600 EVB, see Ref. [10].

## A.5 Configure DA16600 EVB V4.0 to Use AT Commands Using UART2

The DA16200 supports AT commands over UART. There are 3 UARTs on the DA16200, and UART2 is available for AT commands as UART0 and UART1 are occupied for other purposes in DA16600. However, manual modifications are required to use AT commands using UART2 because it is not connected FT2232H on EVB v4.0.

### A.5.1 Turn Off Switch

P0\_5 of DA14531 for 1-wired UART is connected to FT2232H on the EVB. To disconnect the P0\_5 from FT2232H, SW3 and 5~8 of SW7 should be turned off. See Figure 86.



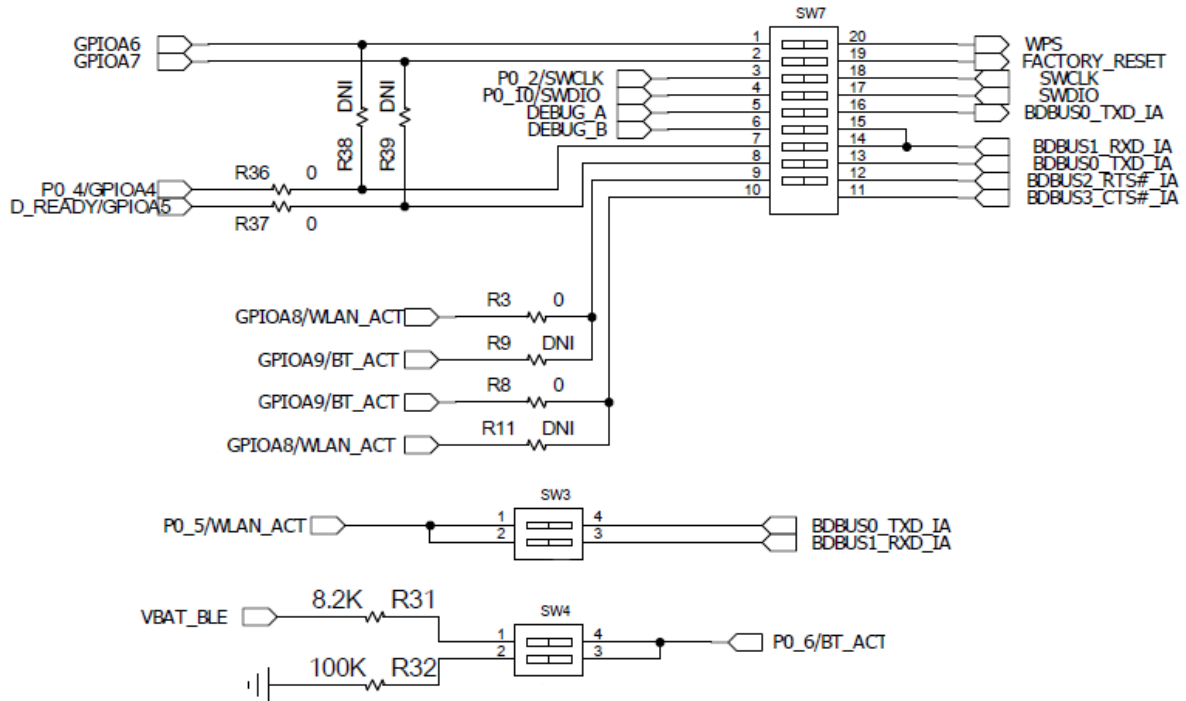

Figure 86. SW3 and SW7 UART1 connection

### A.5.2 Connect UART2 to FT232H

In the DA16600 firmware image, GPIOC6 and GPIOC7 are set as UART2 for AT commands by default. The GPIOC6 and GPIOC7 are connected to pin 2 and pin 4 of J2 connector, and SW3 is connected to FT232H. To use AT commands, the two GPIO pins should be connected to FT232H, and therefore connect the wires from SW3 to J2. See [Figure 87](#).

Pin	UART2
TP	
TP	
GPIOA2	
GPIOA3	
TP	
TP	
GPIOA6	
GPIOA7	
GPIOA8	
GPIOA9	
GPIOA10	TXD
GPIOA11	RXD
TCLK/GPIOA15	
TMS	
UART_TXD	
UART_RXD	
GPIOC8	
GPIOC7	RXD
GPIOC6	TXD

To use UART 2, SW3 and 5~8 of SW7 should be off. In this picture, move the direction of the dip switch to the right.

For UART 2, available GPIOs are GPIOC 6/7 and GPIOA 10/11. GPIOC 6/7 are set as UART2 in AT-CMD image which is provided on Dialog homepage.

Figure 87. Connect UART2 to FT232H

Figure 88 is a snapshot of EVB v4.0 about the modification and connection.

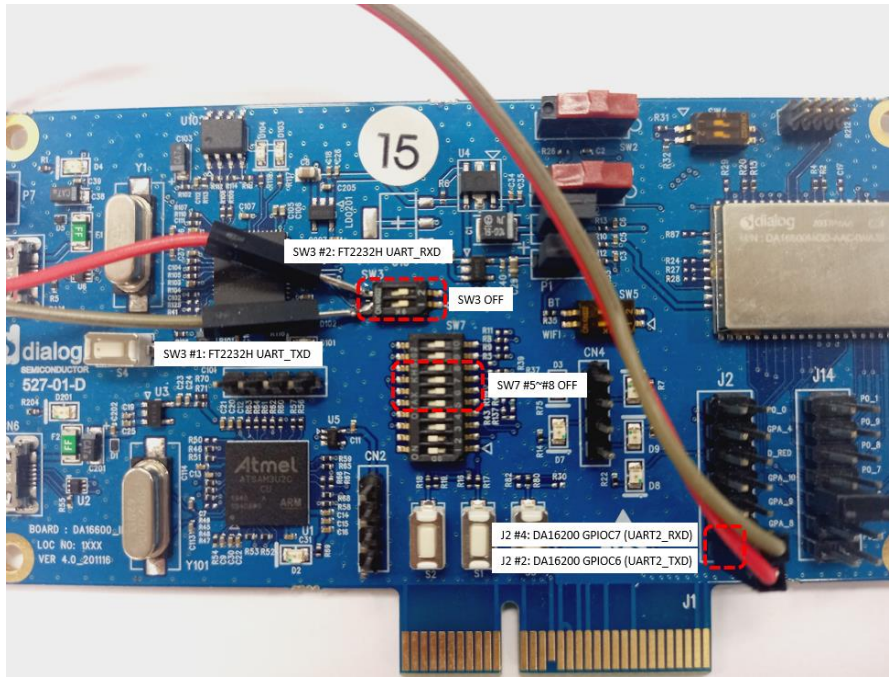

Figure 88. Modification and connection of EVB V4.0

## Appendix B DA16200 Debug Interface Commands

The DA16200 has various console commands to operate its functions. The UART0 interface connects the console with a serial terminal tool. Some commands in the following sections may be disabled according to the SDK's features configuration.

### B.1 Console Command

The DA16200 console commands are categorized as follows:

- **root**
  - [/DA16200] #
- **mem**
  - [/DA16200/MEM] #
- **sys**
  - [/DA16200/SYS] #
- **nvrAm**
  - [/DA16200/NVRAM] #
- **net**
  - [/DA16200/NET] #
- **user**
  - [/DA16200/USER] #

Use command `help` or `?` (Question mark) to list the available commands and options.

There is a function to display the console command history, and up to 5 commands can be saved. Use the following keys and characters to access the history function:

- `↑` or `↓` (arrow key) on your keyboard: show the command history one by one.
- `!` (Exclamation mark): view the list of command history.
- `!` (Exclamation mark) + Number: select and execute one previous command in the list.

It is possible to move between categories. Use these options:

- `top`: move to the highest-rank, root.
- `up`: move to one step upper rank category.
- **Category command** (for example `sys`, `nvrAm`, `net`): move to the category. To run each command of each category, go to the category first, or prefix the category name to the command as shown in the example:
  - `net`
  - `net.ifconfig`

#### B.1.1 Root Commands

Table 25. Root commands

Command	Parameters	Description
<code>help /?</code>	(none)	Display help information for the corresponding category.
<code>up</code>	(none)	Move up one rank category.
<code>top</code>	(none)	Move to the Root category.
<code>factory</code>	(none)	Delete <code>nvrAm</code> data and certificates and perform software reboot.
<code>ps</code>	(none)	Display thread information.
<code>setup</code>	(none)	DA16200 general function setting wizard (Easy Setup). Make step-by-step configuration settings for elements such as SYSMODE, WI-FI, and NETWORK.
<code>reboot</code>	(none) [mode]	Reboot. <code>por</code> : POR rebooting.
<code>reset</code>	(none)	Reset to the Bootloader prompt.

Command	Parameters	Description
ver	(none)	Display SDK version and system information.
time	[option]	Display or set the current time. time set [YYYY-MM-DD] [hh:mm:ss]: set date and time. time zone [-hh:mm]: set time zone. time boot: display booting time. time uptime: display booting duration. time help: display help.
getwlanmac	(none)	Display the MAC address for network interfaces.
setwlanmac	[xx:xx:xx:xx:xx:xx   xx-xx-xx-xx-xx-xx   xxxxxxxxxxxx]	Set up the MAC address for network interfaces. For example: setwlanmac aa:bb:cc:00:00:02   aa-bb-cc-00-00-02   aabbcc000002
dpm	[options]	Set DPM condition. on   off: DPM feature enabled or disabled. status: DPM status print. rtm: view DPM backup data. rtc: view DPM RTC timer. debug [level]: turn DPM debug on/off. level = 1(MSG_ERROR), 2(MSG_INFO), 3(MSG_DEBUG), 4(MSG_EXCESSIVE)

## B.1.2 Network Commands

To move to the network command category, type the command `net`.

Table 26. Network commands

Command	Parameter	Description
arp	[interface] [options]	Display the ARP table of a network interface. <ul style="list-style-type: none"> <li>a: display the ARP table of every interface.</li> <li>d: delete all of ARP table.</li> </ul> Help: Help displays.
arp send	[interface] [dst ipaddress]	Transmit the ARP request message of the target IP. For example: arp send wlan0 10.0.0.1
garp send	[interface] [option]	Transmit a GARP message with options: <ul style="list-style-type: none"> <li>0: normal garp.</li> <li>1: check IP conflict.</li> </ul> For example: arp send wlan0
Arping	[interface] [options]	Send ARP ping to target IP. <ul style="list-style-type: none"> <li>-I [wlan0 wlan1]: Interface name.</li> <li>-n or -c count: Stop after sending count ARP REQUEST.</li> <li>-w timeout: Specify a timeout, in milliseconds, before arping exists regardless of how many packets are sent or received (Min:10 ms).</li> <li>-i interval: Interval in milliseconds to wait for each reply (MIN:10 ms).</li> </ul> For example: arping 172.16.0.1 -n 10 -w 1000 -i 1000
dhcpd	[interface] [options]	DHCP server setting (Only Soft AP mode). <ul style="list-style-type: none"> <li>boot [on off]: automatic start setting with a certain interface.</li> <li>range &lt;Start IP ADDRESS&gt; &lt;END IP Address&gt;: IP lease band setting (max. 10).</li> <li>lease_time &lt;Integer&gt;: lease time setting (min. 60 sec.).</li> </ul>

Command	Parameter	Description
		<ul style="list-style-type: none"> <li>▪ dns &lt;IP Address&gt;: lease IP DNS server address setting.</li> <li>▪ response_delay &lt;Integer&gt;: time of response delay.</li> <li>▪ status: display DHCP server status.</li> <li>▪ lease [0 1]: display IP lease table.</li> </ul> <p>Display tables including un-allotted tables when flag = 1.</p>
ifconfig	(none) [interface wlan0 wlan1] [options]	<p>Display or set the basic network setting and status.</p> <ul style="list-style-type: none"> <li>▪ ifconfig: display basic network settings information.</li> <li>▪ ifconfig -a: display details of all network interfaces.</li> <li>▪ ifconfig [wlan0 wlan1]: display details of a network interface.</li> <li>▪ ifconfig [wlan0 wlan1] [ipaddress] [subnet] [gateway]: set static IP addresses to a network interface.</li> <li>▪ ifconfig [wlan0 wlan1] dhcp: enable/Disable DCHP to a network interface.</li> <li>▪ ifconfig [wlan0 wlan1] [up down]: go Up/Down a network interface.</li> <li>▪ ifconfig [wlan0 wlan1] [start stop renew release]: DHCP client command.</li> <li>▪ ifconfig [wlan0 wlan1] [dns] [DNS ServerIP]: set DNS server address (static IP) to a network interface.</li> <li>▪ ifconfig help: display help.</li> </ul>
ping	-I [interface wlan0 wlan1] [domain ip] -n [count] -l [size] -w [timeout] -i [interval]	<p>Ping test to the target address with a certain option.</p> <ul style="list-style-type: none"> <li>▪ [interface wlan0 wlan1]: <ul style="list-style-type: none"> <li>• Network interface. With no designated interface, an interface for a subnet band of the same destination IP address is designated.</li> </ul> </li> <li>▪ [count]: the count of ping tests.</li> <li>▪ [size]: the size of data to be transmitted (max.: 10000).</li> <li>▪ [timeout]: waiting time for a response to the transmitted message (min.: 10 ms).</li> <li>▪ [interval]: waiting time for a message transmission (min.: 10 ms).</li> <li>▪ [-6]: ping test with an IPv6 address.</li> </ul> <p>For example: ping 172.16.0.1 -l 1024 -n 10 -w 1000 -i 1000 ping -6 fe80::1:2 -I wlan0</p>
sntp	[option]	<p>Show or configure for SNTP operation.</p> <ul style="list-style-type: none"> <li>▪ status: Show current SNTP configuration.</li> <li>▪ enable   disable</li> <li>▪ addr [server]: First SNTP server address.</li> <li>▪ addr_2 [server]: Second SNTP server address.</li> <li>▪ addr_3 [server]: Third SNTP server address.</li> <li>▪ period [second]: Set SNTP renewal time.</li> <li>▪ sync: Run SNTP sync with current SNTP server.</li> </ul>
iperf	-I [interface] [-s -c host] [options]	<p>Set up iPerf client/server.</p>
mqtt_client	[options]	<p>Run or show the status of the MQTT Client.</p> <ul style="list-style-type: none"> <li>▪ start: start mqtt_client.</li> <li>▪ stop: stop mqtt_client.</li> <li>▪ check: check mqtt_client connection.</li> <li>▪ -m {msg} [topic] publish {msg} with [topic]</li> </ul>

Command	Parameter	Description
		: if [topic] is not specified, the one stored in NVRAM is used. <ul style="list-style-type: none"> <li>-1: publish long message.</li> </ul>
cli	[options]	See Section B.2.
debug	[options]	Execute various types of debug commands. <ul style="list-style-type: none"> <li>arp [on off]: arp debug message output on/off.</li> <li>dhcpd [level]: DHCP server debug level setting (level = 0~2 default 0).</li> <li>dhcpc [level]: DHCP Client debug level setting (level = 0~5 default 1).</li> <li>umac [on off] mask: debug umac 1 0x4.</li> </ul>
rsi	[wlan0 wlan1]	Show RSSI value for currently connected interface.
Getsysmode	[none]	Show current Wi-Fi operation mode.

## B.2 CLI Command

### B.2.1 Overview

The DA16200 supplicant plays a key role in providing Wi-Fi functionality. Major functions include IEEE 802.11 management frame, various security functions (WPA & RSN by IEEE 802.11i) and Command Line Interface (CLI) to control DA16200 Wi-Fi performance. The CLI in the DA16200 can execute commands in the network command state.

For example, in Station Mode, the network information of the DA16200 can be displayed using the `cli status` command while in network command state.

```

[/DA16200] # net                               Switch to network command mode.
      Command-List is changed, "NET"
[/DA16200/NET] # cli status                     Display Network Information.
sta0
mac_address=d4:3d:39:10:a2:48
bssid=80:ca:4b:30:02:0a
ssid=U+Net0208
id=0
mode=STATION
key_mgmt=WPA2-PSK
pairwise_cipher=CCMP
group_cipher=CCMP
channel=4
wpa_state=COMPLETED
    
```

### B.2.2 CLI Format

There are four CLI formats (Type A~D):

- Read/Write Parameter (Type A)
  - Read: [/DA16200/NET] # cli [CLI]
  - Write: [/DA16200/NET] # cli [CLI] <VALUE>
- Write Only Parameter (Type B)
  - [/DA16200/NET] # cli [CLI] <VALUE> or cli [CLI] <OPTION> <VALUE>
- Read Only Parameter (Type C)



- [/DA16200/NET] # cli [CLI] or cli [CLI] <OPTION>
- Execution Parameter (Type D)
  - [/DA16200/NET] # cli [CLI] or cli [CLI] < OPTION>

### B.2.3 Common Commands

Table 27. CLI commands in common mode

CLI	Parameter	Description
status	(none)	Get the main information on the interface being operated in the DA16200. For example: [/DA16200/NET] # cli status
save_config	(none)	Save all parameters modified through CLI in NVRAM. (Saved values become applicable after a reboot) (D) For example: [/DA16200/NET] # cli save_config * Information saved in NVRAM may be inquired with the following command: For example: [/DA16200/NVRAM] # printenv Total length (95) country_code (STR,03) ..... KR SYSMODE (STR,02) ..... 0 0: NETMODE (STR,02) ..... 1 NO_Profile (STR,02) ..... 1 NO_ssid (STR,16) ..... "ACST_AC_TEST1"
select_network	<mode>	Execute a motion in a certain mode (STA access, AP operation) (D). <mode> STA: 0   AP: 1 ▪ For example: [/DA16200/NET] # cli select_network 0 • Implement STA access ▪ For a certain mode through the select_network CLI, the following tasks need to be carried out first: • add_network (profile generation). • SSID generation through set_network. • For AP operation, set up the frequency and country code values with command set_network. • For Security, generate WPA or WEP key values with command set_network (optional).
add_network	<mode>	Generate a specific mode (STA, AP) Profile (access information table) (D). <mode>: 0(STA)   1(AP) ▪ For example: [/DA16200/NET] # cli add_network 1 • Generate a profile for AP Mode.
remove_network	<mode>	Delete a certain mode (STA, AP) profile (D). <mode>: 0(STA)   1(AP) ▪ For example: [/DA16200/NET] # cli remove_network 1 • Delete a profile for AP Mode.
set_network	<mode> <variable> <value>	Set parameter values for a specific mode (STA, AP) (B). <mode>: 0(STA)   1(AP) <variable>: a specific parameter.

CLI	Parameter	Description
		<ul style="list-style-type: none"> <li>▪ ssid: [STA] Operation SSID for AP SSID/[AP] AP interface to be connected.</li> <li>▪ psk: passphrase or PSK values.</li> <li>▪ proto: for WPA use, set up the version (&lt;WPA(=WPA1)&gt;   &lt;RSN(=WPA2)&gt;   &lt;WPA RSN&gt;).</li> <li>▪ key_mgmt: key management mode (&lt;NONE&gt;   &lt;WPA_PSK&gt;   &lt;WPA-EAP&gt;).</li> <li>▪ pairwise: unicast data message encryption mode (&lt;TKIP&gt;   &lt;CCMP&gt;   &lt;TKIP CCMP&gt;).</li> <li>▪ group: broadcast data message encryption mode (&lt;TKIP&gt;   &lt;CCMP&gt;   &lt;TKIP CCMP&gt;).</li> <li>▪ wep_key#: WEP key (#:0~3) values.</li> <li>▪ wep_tx_keyidx: WEP key index to be used.</li> <li>▪ frequency: [AP] Operation Frequency (MHz).</li> <li>▪ mode: Operation Mode &lt;0(STA)&gt;   &lt;2(AP)&gt;.</li> <li>▪ Wi-Fi_mode: &lt;0(BGN)&gt;   &lt;1(GN)&gt;   &lt;2(BG)&gt;   &lt;3(N)&gt;   &lt;4(G)&gt;   &lt;5(B)&gt;.</li> <li>▪ beacon_int: [AP] Beacon transport interval.</li> <li>▪ dtim_period: [AP] DTIM interval.</li> <li>▪ ap_power: [AP] Output Power (dBm).</li> <li>▪ isolate: 'Isolate' Use (&lt;0(off)&gt;   &lt;1(on)&gt;).</li> <li>▪ -disabled: Prevent automatic profiling on reboot (&lt;0(off)&gt;   &lt;1(on)&gt;).</li> <li>▪ &lt;value&gt;: settings for a certain variable.</li> <li>▪ For example: [/DA16200/NET] # cli set_network 1 ssid 'DA16200_AP'                             <ul style="list-style-type: none"> <li>• For DA16200 AP operation, SSID= DA16200_AP setting.</li> </ul> </li> <li>▪ For example: [/DA16200/NET] # cli set_network 1 beacon_int 200                             <ul style="list-style-type: none"> <li>• For DA16200 AP operation, Beacon interval 20 ms setting.</li> </ul> </li> <li>▪ For example: [/DA16200/NET] # cli set_network 0 key_mgmt WPA_PSK                             <ul style="list-style-type: none"> <li>• For DA16200 STA operation, access in the WPA PSK security mode.</li> </ul> </li> </ul> <p>A profile needs to be generated with command <code>add_network</code> so that a profile can be set with command <code>set_network</code> (with no profile, 'FAIL').</p>
get_network	<mode> <variable>	<p>Get specific parameter values for a specific mode (STA, AP) (C).</p> <p>&lt;mode&gt;: 0(STA)   1(AP).</p> <p>&lt;variable&gt;: a specific parameter.</p> <ul style="list-style-type: none"> <li>▪ For example: [/DA16200/NET] # cli set_network 0 ssid                             <ul style="list-style-type: none"> <li>• Inquiry of an object subject to DA16200 STA access ("TEST_BED_AP").</li> </ul> </li> <li>▪ For example: [/DA16200/NET] # cli set_network 1 psk                             <ul style="list-style-type: none"> <li>• For DA16200 AP operation, inquiry of the PSK password setting.</li> </ul> </li> </ul>
country	<value>	<p>Set a country related to channel operation (A).</p> <p>&lt;value&gt;: Country Code that meets ISO 3166-1 alpha-2 standards.</p> <p>Default: KR</p> <ul style="list-style-type: none"> <li>▪ For example: [/DA16200/NET] # cli country US                             <ul style="list-style-type: none"> <li>• Set the Country Code to the US.</li> </ul> </li> </ul>



CLI	Parameter	Description
		<ul style="list-style-type: none"> <li>For example: [/DA16200/NET] # cli country                             <ul style="list-style-type: none"> <li>KR</li> </ul> </li> </ul>
flush	(none)	For every interface (STA, AP), the DA16200 deletes the Profile and closes DA16200 service operation (D).

## B.2.4 STA Commands

Table 28. CLI commands on STA mode

Command	Parameters	Description
scan	(none) or <freq>	Active scanning (Probe Request Broadcast) (D). For <freq> inputs, it is possible to scan APs of a certain frequency range (MHz) only (optional). <ul style="list-style-type: none"> <li>For example: [/DA16200/NET] # cli scan                             <ul style="list-style-type: none"> <li>Scan all channels that correspond to the current country setting.</li> </ul> </li> </ul>
disconnect	(none)	Disconnect the accessed AP (D). <ul style="list-style-type: none"> <li>For example: [/DA16200/NET] # cli disconnect                             <ul style="list-style-type: none"> <li>OK (With no AP being accessed, "FAIL").</li> </ul> </li> </ul>
roam	(none) or <oper>	Roaming On/Off and Roaming status inquiry (A). <oper> run: On   stop: Off Default: Roaming Off <ul style="list-style-type: none"> <li>For example: [/DA16200/NET] # cli roam                             <ul style="list-style-type: none"> <li>Roaming = STOP, Threshold = -65</li> <li>Usage: cli roam [run/stop].</li> </ul> </li> <li>For example: [/DA16200/NET] # cli roam stop                             <ul style="list-style-type: none"> <li>Roaming function-off.</li> </ul> </li> </ul>
roam_threshold	<value>	Roaming triggers RSSI value (dBm) setting (B). <value>: Roaming threshold RSSI (dBm). Default: -65 (dBm) <ul style="list-style-type: none"> <li>For example: [/DA16200/NET] # cli roam_threshold -85                             <ul style="list-style-type: none"> <li>Set the roaming threshold to -85 dBm.</li> </ul> </li> </ul>

## B.2.5 Soft AP Commands

Table 29. CLI commands on Soft AP mode

Command	Parameter	Description
ap	<option>	AP interface beginning/closing/restarting (Applicable with no reboot after main info. modification of AP interface SSID, PSK) (D). <option>: start   stop   restart. <ul style="list-style-type: none"> <li>For example: [/DA16200/NET] # cli ap start                             <ul style="list-style-type: none"> <li>AP interface initiating (If it is being operated, 'FAIL').</li> </ul> </li> <li>For example: [/DA16200/NET] # cli ap stop                             <ul style="list-style-type: none"> <li>AP interface closing (If not being operated, 'FAIL').</li> </ul> </li> <li>For example: [/DA16200/NET] # cli set_network 1 ssid 'DA16200_AP2'</li> <li>For example: [/DA16200/NET] # cli ap restart                             <ul style="list-style-type: none"> <li>Modify SSID of the interface of AP being operated.</li> </ul> </li> <li>For example: [/DA16200/NET] # cli set_network 1 pairwise TKIP</li> <li>For example: [/DA16200/NET] # cli ap restart                             <ul style="list-style-type: none"> <li>Modify the AP interface encryption mode to TKIP.</li> </ul> </li> </ul>

Command	Parameter	Description
ap_chan_switch	<Ch.>	<p>Modify the AP interface operation channel (B).</p> <p>&lt;Ch.&gt;: AP operation channel (1~13) or frequency (MHz).</p> <ul style="list-style-type: none"> <li>▪ For example: [/DA16200/NET] # cli ap_chan_switch 3 <ul style="list-style-type: none"> <li>• Modify the AP interface channel to 3 (242 MHz).</li> </ul> </li> <li>▪ For example: [/DA16200/NET] # cli ap_chan_switch 11 2462 <ul style="list-style-type: none"> <li>• Modify the AP interface channel to 11 (2462 MHz).</li> </ul> </li> </ul>
ap_status	(none)	<p>Get the main information about the interface in the DA16200 (C).</p> <p>For example:</p> <pre>[/DA16200/NET] # cli ap_status state=ENABLED  phy=fc9k_phy0 freq=2472  num_sta_non_erp=0 num_sta_no_short_slot_time=0 num_sta_no_short_preamble=0 olbc=0  num_sta_ht_no_gf=0 num_sta_no_ht=0 num_sta_ht_20_mhz=0 num_sta_ht40_intolerant=0  olbc_ht=0 ht_op_mode=0x0 cac_time_seconds=0 cac_time_l</pre>
all_sta	(none)	<p>Output the list information of STA being accessed to the AP interface (C).</p> <p>For example:</p> <pre>[/DA16200/NET] # cli all_sta 50:77:05:DB:C4:3E flags=[AUTH] [ASSOC] [AUTHORIZED] [SHORT_PREAMBLE] [WMM aid=1 capability=0x431 listen_interval=10 mode = 802.11n timeout_next=0 rx_packets=632 tx_packets=9 rx_bytes=67451 tx_bytes=4767 connected_time=77 sta_count=1</pre>

Command	Parameter	Description
deauthenticate	<addr>	The deauthenticate message is transmitted to the access STA with a certain MAC address to cancel the access (D). <addr>: MAC address of the access STA <ul style="list-style-type: none"> <li>For example: [/DA16200/NET] # cli deauthenticate aa:ff:01:00:00:00 <ul style="list-style-type: none"> <li>Transmit the de-authentication message to STA whose MAC address is AA:FF:01:00:00:00.</li> </ul> </li> </ul>
disassociate	<addr>	The disassociation message is transmitted to the access STA with a certain MAC address to cancel the access (D). <addr>: MAC address of the access STA. <ul style="list-style-type: none"> <li>For example: [/DA16200/NET] # cli disassociate aa:ff:01:00:00:00 <ul style="list-style-type: none"> <li>Transmit the disassociation message to STA whose MAC address is AA:FF:01:00:00:00.</li> </ul> </li> </ul>
wmm_enabled	<value>	WMM function availability setting and inquiry (A). <value>: On: 1   Off: 0 Default: Off <ul style="list-style-type: none"> <li>For example: [/DA16200/NET] # cli wmm_enabled 1 <ul style="list-style-type: none"> <li>Use the WMM function.</li> </ul> </li> </ul>
wmm_ps_enabled	<value>	WMM-PS function availability setting and inquiry (A). <value>: On: 1   Off: 0 Default: Off <ul style="list-style-type: none"> <li>For example: [/DA16200/NET] # cli wmm_ps_enabled 1 <ul style="list-style-type: none"> <li>Use the WMM-PS function.</li> </ul> </li> </ul>
wmm_params	<target> <category> <AIFS> <CWmin> <CWmax> <Burst (AP) or TxOP Limit (STA)>	Set up details of DA16200 AP or STA's certain category WMM parameters (B). <target>: ap   sta <category>: be (best-effort)   bk (background)   vi (video)   vo (voice) <ul style="list-style-type: none"> <li>For example: [/DA16200/NET] # cli wmm_params ap be 3 15 63 10 <ul style="list-style-type: none"> <li>For WMM AP's best-effort category, AIFS = 3, CWmin = 15, CWmax = 63, and Burst = 10.</li> </ul> </li> <li>For example: [/DA16200/NET] # cli wmm_params sta vo 4 7 15 60 <ul style="list-style-type: none"> <li>For WMM STA's voice category, AIFS=4, CWmin = 7, CWmax = 15, TXOP_Limit = 60.</li> </ul> </li> </ul>
all_wmm	(none)	Inquiry of all parameters that can be set up by means of wmm_params CLI (C). For example: [/DA16200/NET] # cli all_wmm
acl_mac	<addr>	Add the MAC address to the Access Control Management List (B.) <addr>: AP MAC Address. <ul style="list-style-type: none"> <li>For example: [/DA16200/NET] # cli acl_mac AA:FF:01:00:00:06 <ul style="list-style-type: none"> <li>Add MAC address AA:FF:01:00:00:06 to ACL.</li> </ul> </li> </ul>
Acl	<oper> <addr>	Set up, delete, or inquire about the use of ACL (A). <oper>: allow   deny   clear   delete (If none, inquire of it). <addr>: AP MAC Address (only when oper="delete").

Command	Parameter	Description
		<p>[/DA16200/NET] # cli acl [allow/deny/clear/delete mac_address]</p> <ul style="list-style-type: none"> <li>▪ For example: [/DA16200/NET] # cli acl</li> <li>▪ For example: [/DA16200/NET] # cli acl allow                             <ul style="list-style-type: none"> <li>• Access allowed only for AP Lists in ACL.</li> </ul> </li> <li>▪ For example: [/DA16200/NET] # cli acl deny                             <ul style="list-style-type: none"> <li>• Access denied only for AP Lists in ACL.</li> </ul> </li> <li>▪ For example: [/DA16200/NET] # cli acl clear                             <ul style="list-style-type: none"> <li>• Entire ACL clear.</li> </ul> </li> <li>▪ For example: [/DA16200/NET] # cli delete aa:ff:01:00:00:08                             <ul style="list-style-type: none"> <li>• Delete AA:FF:01:00:00:08 from ACL.</li> </ul> </li> </ul>
ap_max_inactivity	<value>	<p>If there is no data frame exchange of accessed STA during the time setting, disconnect the STA (A).</p> <p>&lt;value&gt;: inactivity timeout (s)</p> <p>Default: 300 (s.)</p> <ul style="list-style-type: none"> <li>▪ For example: [/DA16200/NET] # cli ap_max_inactivity 600                             <ul style="list-style-type: none"> <li>• Disconnect the access STA with no data frame exchange for 600 s</li> </ul> </li> <li>▪ For example: [/DA16200/NET] # cli ap_max_inactivity 0                             <ul style="list-style-type: none"> <li>• Uncheck data frame exchange of the accessed STA</li> </ul> </li> <li>▪ For example: [/DA16200/NET] # cli ap_max_inactivity &lt;value&gt;                             <ul style="list-style-type: none"> <li>• Read ap_max_inactivity value</li> </ul> </li> </ul>
ap_send_ka	<value>	<p>A function to send 'keep-alive' NULL packets to the accessed STA every 30 s and check ACK receipts (A).</p> <p>&lt;value&gt;: On: 1   Off: 0</p> <ul style="list-style-type: none"> <li>▪ On: if the STA accessed to DA16200 AP interface is out of coverage or closed abnormally, disconnection occurs after the 'ap_max_inactivity timeout' passes.</li> <li>▪ Off: if there is no constant data frame exchange with the STA accessed to DA16200 AP interface for ap_max_inactivity timeout, then disconnect.</li> </ul> <p>Default: 0 (not used)</p> <ul style="list-style-type: none"> <li>▪ For example: [/DA16200/NET] # cli ap_send_ka 1                             <ul style="list-style-type: none"> <li>• ap_send_ka = 1</li> </ul> </li> </ul>
ap_rts	<value>	<p>For AP mode operation, set up the RTS Threshold value to be used (A).</p> <p>&lt;value&gt;: The standard for a size of packets that use the RTS Control Frame (bytes).</p> <p>Default: 2437 (bytes)</p> <ul style="list-style-type: none"> <li>▪ For example: [/DA16200/NET] # cli ap_rts 1000                             <ul style="list-style-type: none"> <li>• Use RTS for transmission of 1000 bytes or larger frames</li> <li>• ap_rts = 1000</li> </ul> </li> <li>▪ For example: [/DA16200/NET] # cli ap_rts &lt;value&gt;                             <ul style="list-style-type: none"> <li>• ap_rts = 2437</li> </ul> </li> </ul>
greenfield	<value>	<p>Enable/Disable use of Greenfield.</p> <p>&lt;value&gt;: On: 1   Off: 0</p> <p>If Greenfield is on, DA16200 uses 11n HT mode only. In that case, 11b, 11g information and STA access are not allowed.</p> <p>Default: 0 (not used)</p> <ul style="list-style-type: none"> <li>▪ For example: [/DA16200/NET] # cli greenfield 1</li> </ul>

Command	Parameter	Description
		<ul style="list-style-type: none"> <li>Use the Greenfield function.</li> <li>Greenfield = 1</li> <li>For example: [/DA16200/NET] # cli greenfield</li> <li>Greenfield = 0</li> </ul>

## B.2.6 Advanced Commands

Table 30. Advanced CLI commands

Command	Parameters	Description
wps_pbc	(none)	Run WPS Push Button Configuration (PBC).
wps_pin	<pin>	Run WPS PIN method. <pin> pin code (any: generate a random code). For example: [/DA16200/NET] # cli wps_pin 27833513 For example: [/DA16200/NET] # cli wps_pin any

## B.3 MROM Command

### B.3.1 Common Commands

Table 31. Common commands in MROM

Command	Parameters	Description
!	(none)	None
reboot	(none) [mode]	Reboot. por: POR rebooting.
reset	(none)	Reset to the Bootloader prompt.
ver	(none)	Display version of MaskRom.
help /?	(none)	Display help information for the corresponding category.
boot	[address]	Booting. Address: booting address

### B.3.2 Memory Access Commands

Table 32. Memory access commands in MROM

Command	Parameters	Description
brd	[addr] [length]	Byte read memory.
bwr	[addr] [data] [length]	Byte write memory.
wrd	[addr] [length]	Word read memory.
wwr	[addr] [data] [length]	Word write memory.
lrd	[addr] [length]	Long read memory.
Lwr	[addr] [data] [length]	Long write memory.

### B.3.3 Download Commands

Table 33. Download commands in MROM

Command	Parameters	Description
loady	[addr][sector_size][image_format]	Download the image to SFlash. <ul style="list-style-type: none"> <li>addr: SFlash address to be programmed (See <a href="#">Table 37</a> and <a href="#">Table 38</a>).</li> <li>sector_size: sector size of SFlash, fixed 1000 (4 kB).</li> <li>image_format: format of image. This is an optional parameter and "bin" is only the available value. CRC is checked if it is used. Do not use it for FBOOT firmware image.</li> </ul>

Command	Parameters	Description
		For example: loady 0 1000 // FBOOT loady 23000 1000 // FRTOS loady 3ad000 1000 bin // BLE
ymodem	sfdp	Download SFDP to RAM (address: 0xf80040).

### B.3.4 SFlash Commands

Table 34. SFlash commands in MROM

Command	Parameters	Description
sflash	[op] [start] [length]	SFlash access. <ul style="list-style-type: none"> <li>▪ op: read, write, erase, info</li> <li>▪ start: start address (not required for the <b>info</b>)</li> <li>▪ length: length (not required for the <b>info</b>)</li> </ul>

**NOTE**

Operators not listed in the description such as reset, unlock, lock, and verify are for only internal test purpose.

### B.3.5 Secure Commands

Table 35. Secure commands in MROM

Command	Parameters	Description
sbrom	[target] [bootaddress] [debug]	Secure boot command. <ul style="list-style-type: none"> <li>▪ target: SFlash</li> <li>▪ boot address: 0 (boot) or a000 (rtos)</li> <li>▪ debug: anything</li> </ul>
socid	(none)	Display socid (secure soc id)

### B.3.6 Additional Commands

Table 36. Additional commands in MROM

Command	Parameters	Description
bmcfg	[op] [bootmode]	Boot mode config. Not used.
oops	[op] [value]...	Oops configuration. Not used.
dbgt	[op] [op] [value0]...	Debug mode configuration. Not used.
floady	[addr] [sector_size] [format] [boot]	Fast download image to SFlash. Not used.
rs485	[offset] [id]	Download the image with rs485. Not used.
clock	[new clock]	System clock setting.
setsfl	[mode]	Select SFlash. Mode: 0 (stacked sflash), 1 (external sflash) Used "1" only.

## Appendix C SDK Memory Maps

This section describes the memory maps for the external SFlash device and the internal SRAM, and how to change the SFlash device and adjust the SRAM map used in the SDK. The DA16200/DA16600 SDK provides two types of memory maps: an external SFlash device and an internal 512 kB SRAM.

<b>NOTE</b>
See the table of <b>Recommended Serial Flash List</b> in Ref. [11] for compatible Flash with the DA16200/DA16600.

### C.1 SFlash Memory Map

The DA16200/DA16600 FreeRTOS SDK has 4 MB SFlash map by default.

#### C.1.1 DA16200

Table 37. 4 MB SFlash map for DA16200

Address	Name	Size (kB)
0x0000_0000	2 <sup>nd</sup> Bootloader	136
0x0002_2000	Boot Index	4
0x0002_3000	RTOS #0	1788
0x001E_2000	RTOS #1	1788
0x003A_1000	Reserved Area	4
0x003A_2000	Debug/RMA Certificate	4
0x003A_3000	TLS Certificate #0 (MQTT)	CA
0x003A_4000		Cert
0x003A_5000		Private key
0x003A_6000		Diffie-Hellmann key
0x003A_7000	TLS Certificate #1 (HTTPs/OTA)	CA
0x003A_8000		Cert
0x003A_9000		Private key
0x003A_A000		Diffie-Hellmann key
0x003A_B000	NVRAM #0	4
0x003A_C000	NVRAM #1 (Backup)	4
0x003A_D000	User Area	256
0x003E_D000	TLS Certificate Key #2 (WPA Enterprise)	CA
0x003E_E000		Cert
0x003E_F000		Private
0x003F_0000		Diffie-Hellmann key
0x003F_1000	TLS Certificate Key #3 (Reserved)	CA
0x003F_2000		Certificate
0x003F_3000		Private Key
0x003F_4000		Diffie-Hellmann key
0x003F_5000	NVRAM FOOTPRINT	4
0x003F_6000	AT-CMD TLS Certificate Key #0 ~ #9 (*)	40

<b>NOTE</b>
See the Secure Socket Command of Ref. [5] for usage of "AT-CMD TLS Certificate Key #0 ~ #9" area.

#### C.1.2 DA16600

Table 38. 4 MB SFlash map for DA16600

Address	Name	Size (kB)
0x0000_0000	2 <sup>nd</sup> Bootloader	136
0x0002_2000	Boot Index	4
0x0002_3000	RTOS #0	1788
0x001E_2000	RTOS #1	1788
0x003A_1000	Reserved Area	4
0x003A_2000	Debug/RMA Certificate	4



Address	Name	Size (kB)
0x003A_3000	TLS Certificate #0 (MQTT)	CA
0x003A_4000		Cert
0x003A_5000		Private key
0x003A_6000		Diffie-Hellmann key
0x003A_7000	TLS Certificate #1 (HTTPs/OTA)	CA
0x003A_8000		Cert
0x003A_9000		Private key
0x003A_A000		Diffie-Hellmann key
0x003A_B000	NVRAM #0	4
0x003A_C000	NVRAM #1 (Backup)	4
0x003A_D000	Bluetooth LE Firmware area (Depends on Bluetooth LE_IMG_SIZE, default: 64 kB)	64 ~ 80
0x003B_D000 or 0x003C_1000	Bluetooth® LE Security DB area (Depends on __MULTI_BONDING_SUPPORT__, default: 0 kB)	0 or 4
0x003B_D000 ~ 0x003C_2000	User Area (Start address: 0x003B_D000, default: 192 kB)	172 ~ 192
0x003E_D000	TLS Certificate Key #2 (WPA Enterprise)	CA
0x003E_E000		Cert
0x003E_F000		Private
0x003F_0000		Diffie-Hellmann key
0x003F_1000	TLS Certificate Key #3 (Reserved)	CA
0x003F_2000		Certificate
0x003F_3000		Private Key
0x003F_4000		Diffie-Hellmann key
0x003F_5000	NVRAM FOOTPRINT	4
0x003F_6000	AT-CMD TLS Certificate Key #0 ~ #9 (*)	40

**NOTE**

See Ref. [5] for usage of "AT-CMD TLS Certificate Key #0 ~ #9" area.

The DA16200/DA16600 SDK contains a script to automatically select the SFlash type. See Section 5.5.2 on how the SFlash is selected in e<sup>2</sup> studio. To change the SFlash type without using the script, go to the <sdk\_root\_directory>/tools/SBOOT/config directory and copy the dal6xtpmconfig.cfg.xxxx (4 MB) file that matches the SFlash device that is being used and copy it to dal6xtpmconfig.cfg.

## C.2 SRAM Map

In the FreeRTOS SDK, the overall memory map is organized as shown in [Figure 89](#).

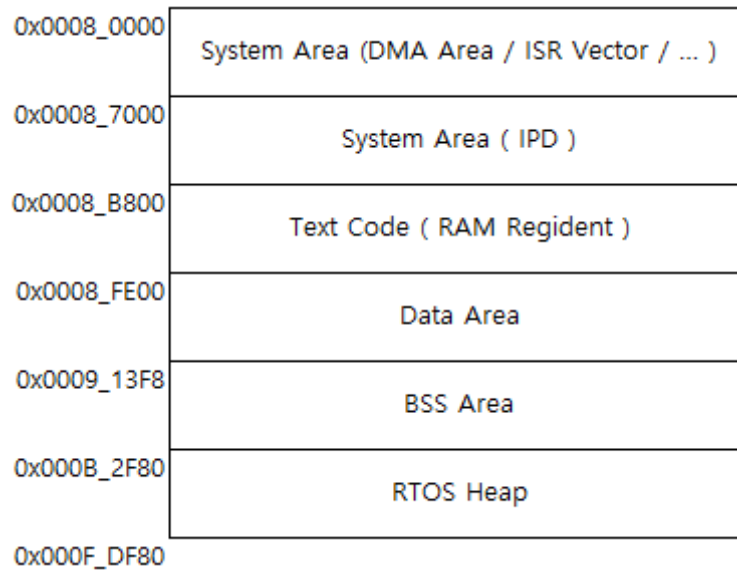

Figure 89. System memory map

## Appendix D Troubleshooting

### D.1 Boot Failure

During the development process, there may be times when there is an error in the code or a problem programming the firmware which can cause the DA16200/DA16600 to fail to boot properly. This may happen because the Serial Flash Discoverable Parameters (SFDP) which are stored in Retention Memory become corrupt or erased. The DA16200/DA16600 requires the SFDP for the SFlash to operate properly. The SFDP parameters are included in the FBOOT firmware image and can be recovered by programming the firmware again.

#### D.1.1 Check SFDP

Switch to [MROM] mode and use the `brd f80000 100` command to check if the SFDP information.

```
[/DA16200] # brd f80000 100
[00F80000] : 00 00 00 01 FF FF FF FF FF FF FF FF 00 00 00 40 .....@
[00F80010] : A1 00 91 FC 00 00 00 00 00 00 00 00 00 00 00 .....
[00F80020] : 0B 00 00 00 C0 D4 01 80 00 00 00 00 89 34 6F 93 .....4o.
[00F80030] : 00 00 00 00 00 00 00 00 00 00 00 00 00 00 01 64 .....d
[00F80040] : 53 46 44 50 15 16 60 EF 00 00 40 00 F5 20 F1 FF SFDP..`.e.. ..
[00F80050] : FF FF FF 01 44 EB 08 6B 08 3B 04 BB EE FF FF FF ....D.k;.....
[00F80060] : FF FF 00 FF FF FF 44 EB 0C 20 0F 52 10 D8 00 FF .....D.. .R....
[00F80070] : 11 34 1E F3 83 3A 00 CC CC 43 1C 62 7A 75 7A 75 .4...:...C.bzuzu
[00F80080] : 07 CD D5 5C 42 00 EF 40 FF 7F 00 01 07 02 36 39 ...\B..@.....69
[00F80090] : 3C FF E1 E0 FF 00 00 00 32 68 68 68 32 64 00 04 <.....2hhh2d..
[00F800A0] : 00 04 00 00 00 00 00 00 90 9F AB 5A 05 01 04 06 .....Z....
[00F800B0] : 50 66 99 00 00 B9 AB 38 FF B7 E9 00 00 02 32 00 Pf.....8.....2.
[00F800C0] : 02 32 00 20 00 0B 60 35 00 00 00 00 00 00 00 00 .2. ..`5.....
[00F800D0] : 00 00 00 00 28 50 78 A0 40 40 40 80 00 00 00 00 ....(Px.@@@.....
[00F800E0] : 00 00 00 00 FF FF FF FF FF FF FF FF FF FF FF FF .....
[00F800F0] : AD B6 F3 D8 00 00 00 00 00 00 00 00 00 00 00 00 .....
[/DA16200] #
```

If the SFDP information is not similar to the one above, then both FBOOT and FRTOS images must be programmed again without reset and reboot.

#### D.1.2 Recovery from Unresponsive Boot

If the DA16200/DA16600 does not boot and the serial command interface is unresponsive, then access can be recovered by following steps:

1. Copy `uart_program_da16200` to the folder which has FBOOT and FRTOS images.
2. Power off the DA16200/DA16600.
3. Run the `uart_program_da16200` and select **number** in list of serial interfaces.
4. Input `emode`.
5. Follow the instructions from `uart_program_da16200`.
6. Confirm the devices enter MROM state.
7. Then the FBOOT and FRTOS images can be programmed manually as follows.
8. Input `dload`.
9. Input **address** for FBOOT image (default address: 0).

10. Select **number** of FBOOT image in lists which shows all images in the folder.
11. Programming is done automatically.
12. Input **y** for more programming.
13. Input **address** for FRTOS image (default address of FRTOS #0: 23000, see Appendix [C.1.1](#) or [C.1.2](#)).
14. Select **number** of FRTOS image in lists which shows all images in the folder.
15. Programming is done automatically.
16. Input **n** because no more programming is required.
17. Input **reboot** and confirm the programmed image works.

```
d:\download>uart_program_da16200.exe
uart_program_da16200 Version 1.0.5
0. COM75 - USB Serial Port (COM75)
1. COM76 - USB Serial Port (COM76)
Please enter a number from the list of your COM port and click Enter.
--> 0
Selected COM port = COM75 - USB Serial Port (COM75)
Entering console mode...
Ready for console mode. Input anything.
2023-07-31 16:49:42.644:[/DA16200] # emode
Entering emergency mode...
Confirm turn off device. Then enter Y and click Enter.
Y
Turn on device within 5 sec.
Entering console mode...
Ready for console mode. Input anything.
2023-07-31 16:50:02.527:
2023-07-31 16:50:02.527:No such command - type help
2023-07-31 16:50:03.033:[MR0M] dload
2023-07-31 16:50:13.519:[MR0M]
2023-07-31 16:50:14.030:[MR0M] Please enter address (0 ~ 3FF000) and click Enter: 0
0. da14531_multi_part_proxr.img
1. DA16200_FBOOT-GEN01-01-c7f4c6cc22_W25Q32JW.img
2. DA16200_FRTOS-GEN01-01-c4ca8087e8-006537.img
Please enter a file name or number in list, and click Enter: 1
Entering download mode...
2023-07-31 16:50:48.824 Ready for download.
Download file 1: DA16200_FBOOT-GEN01-01-c7f4c6cc22_W25Q32JW.img : 100.00% : 8.08s
2023-07-31 16:50:58.033 Done successfully.
Will you continue to download? y or n: y
Please enter address (0 ~ 3FF000) and click Enter: 23000
0. da14531_multi_part_proxr.img
1. DA16200_FBOOT-GEN01-01-c7f4c6cc22_W25Q32JW.img
2. DA16200_FRTOS-GEN01-01-c4ca8087e8-006537.img
```

```
Please enter a file name or number from the list, and click Enter: 2
Entering download mode...
2023-07-31 16:54:14.624 Ready for download.
Download file 1: DA16200_FRTOS-GEN01-01-c4ca8087e8-006537.img : 100.00% : 72.76s
2023-07-31 16:55:28.515 Done successfully.
Will you continue to download? y or n: n
Entering console mode...
Ready for console mode. Input anything.
[MROM] reboot
reboot
Wakeup source is 0x4
[dpm_init_retmemory] DPM INIT CONFIGURATION(1)
*****
*           DA16200 SDK Information
* -----
*
* - CPU Type       : Cortex-M4 (120 MHz)
* - OS Type        : FreeRTOS 10.4.3
* - Serial Flash   : 4 MB
* - SDK Version    : V3.2.8.0 GEN
* - F/W Version    : FRTOS-GEN01-01-c4ca8087e8-006537
* - F/W Build Time : Jul 31 2023 14:07:09
* - Boot Index     : 0
*
*****
System Mode : Station Only (0)
>>> Start DA16X Supplicant ...
>>> DA16x Supp Ver2.7 - 2022_03
>>> MAC address (sta0) : d4:3d:39:11:34:fc
>>> sta0 interface add OK
>>> Start STA mode...
RTC switched to XTAL
>>> Hello World #1 ( Non network dependent application ) !!!
```

### NOTE

Do not reset or power on/off the board between the FBOOT and FRTOS image programming. It causes programming failure.

## Appendix E Country Codes

Table 39. Country codes

Code	Country	Code	Country	Code	Country	Code	Country
AD	Andorra	EC	Ecuador	LC	Saint Lucia	RE	Reunion
AE	United Arab Emirates	EE	Estonia	LI	Liechtenstein	RO	Romania
AF	Afghanistan	EG	Egypt	LK	Sri Lanka	RS	Serbia
AI	Anguilla	ES	Spain	LS	Lesotho	RU	Russia
AL	Albania	ET	Ethiopia	LT	Lithuania	RW	Rwanda
AM	Armenia	EU	Europe	LU	Luxembourg	SA	Saudi
AR	Argentina	FI	Finland	LV	Latvia	SE	Sweden
AS	Samoa	FM	Micronesia	MA	Morocco	SG	Singapore
AT	Austria	FR	France	MC	Monaco	SI	Slovenia
AU	Australia	GA	Gabon	MD	Moldova	SK	Slovakia
AW	Aruba	GB	United Kingdom	ME	Montenegro	SN	Senegal
AZ	Azerbaijan	GD	Grenada	MF	Saint Martin	SR	Suriname
BA	Bosnia	GE	Georgia	MH	Marshall Islands	SV	El Salvador
BB	Barbados	GF	French Guiana	MK	Macedonia	SY	Syria
BD	Bangladesh	GH	Ghana	MN	Mongolia	TC	Turks Caicos
BE	Belgium	GL	Greenland	MO	Macao	TD	Chad
BF	Burkina Faso	GP	Guadeloupe	MP	Northern Mariana Islands	TG	Togo
BG	Bulgaria	GR	Greece	MQ	Martinique	TH	Thailand
BH	Bahrain	GT	Guatemala	MR	Mauritania	TN	Tunisia
BL	Barthelemy	GU	Guam	MT	Malta	TR	Turkey
BM	Bermuda	GY	Guyana	MU	Mauritius	TT	Trinidad and Tobago
BN	Brunei	HK	Hong Kong	MV	Maldives	TW	Taiwan
BO	Bolivia	HN	Honduras	MW	Malawi	TZ	Tanzania
BR	Brazil	HR	Croatia	MX	Mexico	UA	Ukraine
BS	Bahamas	HT	Haiti	MY	Malaysia	UG	Uganda

Code	Country	Code	Country	Code	Country	Code	Country
BT	Bhutan	HU	Hungary	NG	Nigeria	UK	United Kingdom
BY	Belarus	ID	Indonesia	NI	Nicaragua	US	USA
BZ	Belize	IE	Ireland	NL	Netherlands	UY	Uruguay
CA	Canada	IL	Israel	NO	Norway	UZ	Uzbekistan
CF	Central Africa	IN	India	NP	Nepal	VA	Vatican City
CH	Switzerland	IR	Iran	NZ	New Zealand	VC	St. Vincent and Grenadines
CI	Ivory Coast	IS	Iceland	OM	Oman	VE	Venezuela
CL	Chile	IT	Italy	PA	Panama	VI	Virgin Islands, US
CN	China	JM	Jamaica	PE	Peru	VN	Vietnam
CO	Colombia	JO	Jordan	PF	Polynesia	VU	Vanuatu
CR	Costa Rica	JP	Japan	PG	Papua New Guinea	WF	Wallis and Futuna Islands
CU	Cuba	KE	Kenya	PH	Philippines	WS	Samoa
CX	Christmas Island	KH	Cambodia	PK	Pakistan	YE	Yemen
CY	Cyprus	KN	St. Kitts and Nevis	PL	Poland	YT	Mayotte
CZ	Czech	KP	N.Korea	PM	St. Pierre and Miquelon	ZA	S.Africa
DE	Germany	KR	S.Korea	PR	Puerto Rico	ZW	Zimbabwe
DK	Denmark	KW	Kuwait	PT	Portugal	ALL	ALL
DM	Dominica	KY	Cayman Islands	PW	Palau	-	-
DO	Dominican Rep	KZ	Kazakhstan	PY	Paraguay	-	-
DZ	Algeria	LB	Lebanon	QA	Qatar	-	-



## 7. Revision History

Revision	Date	Description
2.4	Oct 31, 2025	<ul style="list-style-type: none"> <li>▪ Added details for module firmware update and pin out for each pre-built images.</li> <li>▪ Updated some schematic captures in Table 1 and Table 3.</li> </ul>
2.3	July 31, 2025	<ul style="list-style-type: none"> <li>▪ Added the Power profiler section.</li> <li>▪ Added DPM mode section.</li> <li>▪ Added sub sections for how to change the boot index.</li> <li>▪ Added e<sup>2</sup> studio version description.</li> </ul>
2.2	Feb 6, 2025	<ul style="list-style-type: none"> <li>▪ Updated the description and added the note for sflash_size.h in Section 5.5.</li> <li>▪ Added note for GDB server connection.</li> </ul>
2.1	Sept 24, 2024	<ul style="list-style-type: none"> <li>▪ Updated the description of Download Commands in Appendix B.3.3.</li> <li>▪ Updated the Jumper P2 usage on Table 1.</li> <li>▪ Updated the description of P2 setup in Section 6.4.2.</li> <li>▪ Updated the description of P10 and P11 in Table 3.</li> <li>▪ Updated iPerf version to v2.0.8.</li> </ul>
2.0	May 29, 2024	<ul style="list-style-type: none"> <li>▪ Updated factory reset button and command related description.</li> <li>▪ Changed Bluetooth image folder name to DA14531_P (FROM DA14531_1).</li> <li>▪ Simplified the note in Appendix C.1 regarding recommended serial flash list.</li> </ul>
1.9	Apr 5, 2024	<ul style="list-style-type: none"> <li>▪ Added Appendix A.5 Configure DA16600 EVB V4.0 to Use AT command using UART2.</li> <li>▪ Added descriptions in Connect J-Link section.</li> <li>▪ Updated the description of SFlash Commands in MROM table.</li> </ul>
1.8	Aug 18, 2023	<ul style="list-style-type: none"> <li>▪ Changed IDE to e<sup>2</sup> studio in the section of Software Development.</li> <li>▪ Updated how to program the firmware image in section of Using uart_program_da16200 in Console Terminal.</li> <li>▪ Updated recovering way in the section of Troubleshooting.</li> <li>▪ Updated how to measure current in each mode in the section of Current Measurement.</li> <li>▪ Updated descriptions about DPM mode in the section of DPM Setup.</li> <li>▪ Changed "DPM sleep" to "DPM low power".</li> </ul>
1.7	June 30, 2023	<ul style="list-style-type: none"> <li>▪ Fixed the title of section DA16600 EVB V5.0.</li> <li>▪ Updated the reference section.</li> </ul>
1.6	Mar 16, 2023	Changed Windows build tools version.
1.5	Jan 12, 2023	<ul style="list-style-type: none"> <li>▪ Added installation using batch/shell script.</li> <li>▪ Changed location of firmware image files in the section of Importing DA16200 FreeRTOS SDK Project into e<sup>2</sup> studio.</li> <li>▪ Added build configuration (Release/Debug) in the section of Build Configurations.</li> <li>▪ Added how to move project location in the section of Installing e<sup>2</sup> studio IDE.</li> <li>▪ Added Current Measurements from UM-WI-040 to the section of Test Setup with EVK Pro Board.</li> </ul>
1.4	Oct 25, 2022	Added description of project presentation option in Section 5.7.
1.3	June 14, 2022	<ul style="list-style-type: none"> <li>▪ Updated console commands in Appendix B.1.1 and B.1.2.</li> <li>▪ Updated SFLASH memory map in Appendix C.2.</li> <li>▪ Updated J-Link section.</li> </ul>
1.2	Apr 11, 2022	<ul style="list-style-type: none"> <li>▪ Updated logo, disclaimer, copyright.</li> <li>▪ Added link to J-Link/J-Trace User Guide (UM08001) in Section 5.6.</li> </ul>
1.1	Nov 29, 2021	Title changed.
1.0	Oct 27, 2021	First release.

### Status Definitions

Status	Definition
DRAFT	The content of this document is under review and subject to formal approval, which may result in modifications or additions.
APPROVED or unmarked	The content of this document has been approved for publication.

### ROHS COMPLIANCE

Renesas Electronics' suppliers certify that its products are in compliance with the requirements of Directive 2011/65/EU of the European Parliament on the restriction of the use of certain hazardous substances in electrical and electronic equipment. RoHS certificates from our suppliers are available on request.

### IMPORTANT NOTICE AND DISCLAIMER

RENESAS ELECTRONICS CORPORATION AND ITS SUBSIDIARIES (“RENESAS”) PROVIDES TECHNICAL SPECIFICATIONS AND RELIABILITY DATA (INCLUDING DATASHEETS), DESIGN RESOURCES (INCLUDING REFERENCE DESIGNS), APPLICATION OR OTHER DESIGN ADVICE, WEB TOOLS, SAFETY INFORMATION, AND OTHER RESOURCES “AS IS” AND WITH ALL FAULTS, AND DISCLAIMS ALL WARRANTIES, EXPRESS OR IMPLIED, INCLUDING, WITHOUT LIMITATION, ANY IMPLIED WARRANTIES OF MERCHANTABILITY, FITNESS FOR A PARTICULAR PURPOSE, OR NON-INFRINGEMENT OF THIRD-PARTY INTELLECTUAL PROPERTY RIGHTS.

These resources are intended for developers who are designing with Renesas products. You are solely responsible for (1) selecting the appropriate products for your application, (2) designing, validating, and testing your application, and (3) ensuring your application meets applicable standards, and any other safety, security, or other requirements. These resources are subject to change without notice. Renesas grants you permission to use these resources only to develop an application that uses Renesas products. Other reproduction or use of these resources is strictly prohibited. No license is granted to any other Renesas intellectual property or to any third-party intellectual property. Renesas disclaims responsibility for, and you will fully indemnify Renesas and its representatives against, any claims, damages, costs, losses, or liabilities arising from your use of these resources. Renesas' products are provided only subject to Renesas' Terms and Conditions of Sale or other applicable terms agreed to in writing. No use of any Renesas resources expands or otherwise alters any applicable warranties or warranty disclaimers for these products.

(Disclaimer Rev.1.1 Jan 2024)

### Corporate Headquarters

TOYOSU FORESIA, 3-2-24 Toyosu  
Koto-ku, Tokyo 135-0061, Japan

[www.renesas.com](http://www.renesas.com)

### Trademarks

Renesas and the Renesas logo are trademarks of Renesas Electronics Corporation. All trademarks and registered trademarks are the property of their respective owners.

### Contact Information

For further information on a product, technology, the most up-to-date version of a document, or your nearest sales office, please visit [www.renesas.com/contact-us/](http://www.renesas.com/contact-us/)

© 2025 Renesas Electronics Corporation. All rights reserved.