

Evaluation of Subsystem Clock Oscillation Circuit

[HD64F38124H-80A] QFP(14x14) 0.65mm pitch

Measurement conditions : 5.0V , 3.3V



Model :SP-T2A
 Frequency :Fo=32.768kHz
 Frequency tolerance :dF/Fo= +/-20x10⁶
 Load capacitance :CL=12.5pF
 Equivalent series resistance :R1=50k ohm max
 Max. Drive level :DL=1x10⁶W max
 Recommended drive level :DL=0.1x10⁶W typ

FEATURES

1. Plastic mold package incorporated tubular type quartz crystal.
2. Suitable for automatic and high density surface mounting.
3. Excellent shock and heat resistance
4. Real time clocks, Timers, Portable applications, Clock source for Micro-Computers

RECOMMENDED SOLDERIN PATTERN

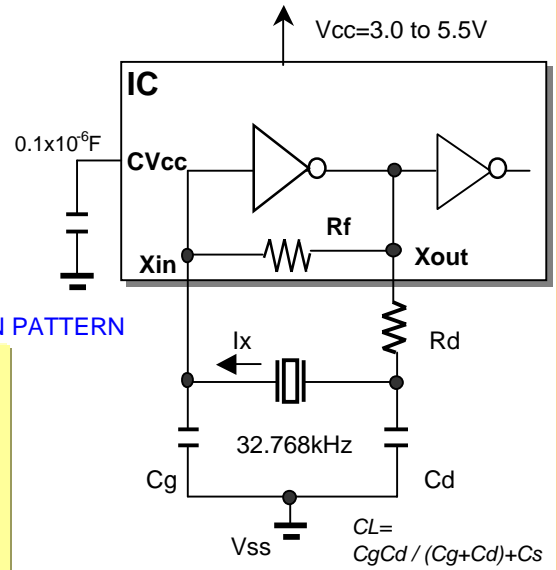
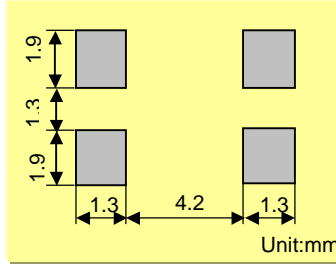

Remark) Ix : current through crystal

When the internal power supply Step-Down circuit is not used, please connect the external power supply to the CVcc pin and Vcc pin.

The permissible range for the power supply voltage is 3.0V to 3.6V.

MODEL:SP-T2A 12.5pF with HD64F38124H at 25°C

Key specifications	Vcc=3.3V	Vcc=5.0V	Remarks
Current control resistance : Rd (k ohm)	0	0	Control drive level & secure phase margin
Capacitance at gate : Cg (pF)	20	20	Optimal capacity in response to CL
Capacitance at drain : Cd (pF)	20	20	(CL = Cd // Cg + stray capacitance)

Circuit characteristics (at 25°C)	Vcc=3.3V	Vcc=5.0V	Remarks
Matching Accuracy : df / f (x10 ⁻⁶)	-2.1	-1.5	Frequency offset volume at specified Vdd
Voltage Fluctuation : +/-df / V (x10 ⁻⁶)	0.2	0.0	Vdd +/-10% (Standard operating voltage range)
Drive Level : DL (x10 ⁻⁶ W)	0.29	0.29	DL=Ix ² Re < 1x10 ⁻⁶ W, Re=R1(1 + Co / CL) ²
Negative resistance : - RL (kohm)	935	935	5 times larger than R _{1MAX}
Oscillation allowance : M (times)	18.7	18.7	Judgemental standard of oscillation stability
Oscillation start up time : Ts (sec)	0.62	0.59	Time to reach 90% of output level

Temperature characteristics of circuit	Vcc=3.3V	Vcc=5.0V	Remarks
at -40°C Variation : df / T (x10 ⁻⁶)	-142	-142	Typ.Tp=25°C (K = -3.5x10 ⁻⁸ / °C ²)
at +85°C Variation : df / T (x10 ⁻⁶)	-125	-125	Typ.Tp=25°C (K = -3.5x10 ⁻⁸ / °C ²)

The mention value is only for your reference. The value is for the arbitrary samples and does not guarantee the product's characteristics. Please review and check above parameters at customer's end.

Seiko Instruments USA Inc.

2990,West Lomita Blvd., Torrance, CA 90505, U.S.A
 Telephone :+1 310-517-7771 Facsimile :+1 310-517-7792
 Email :crystals@siu-la.com

Seiko Instruments GmbH

Siemensstrasse 9,D-63263 Neu-Isenburg,Germany
 Telephone :+49-6102-297-0 Facsimile :+49-6102-297-320
 Email :info@seiko-instruments.de

Seiko Instruments Inc.

1-8,Nakase,Mihama-ku,Chiba-shi,Chiba 261-8507,Japan
 Facsimile :+81-43-211-8030 E-mail :component@sii.co.jp



We value the "takumi" spirit.

Seiko Instruments Inc.
 Phone:+81-43-211-1207(Direct)

Evaluation of Subsystem Clock Oscillation Circuit

[HD64F38124H-80A] QFP(14x14) 0.65mm pitch

Measurement conditions : 5.0V , 3.3V



Test Data

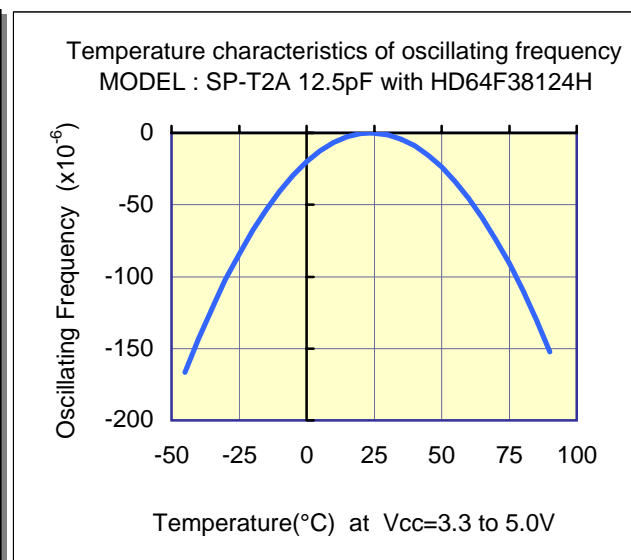
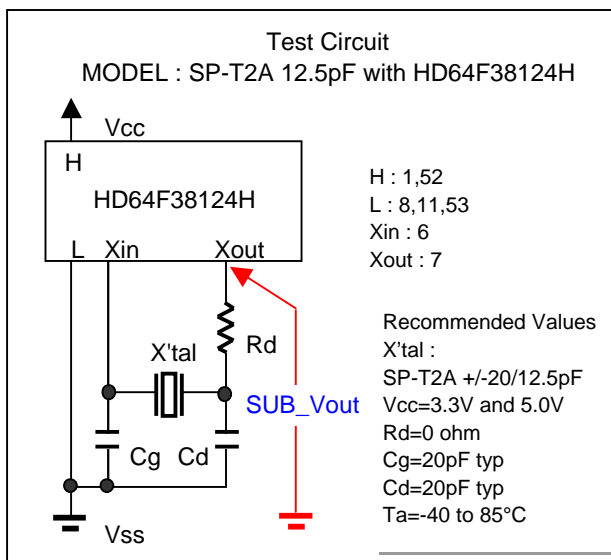
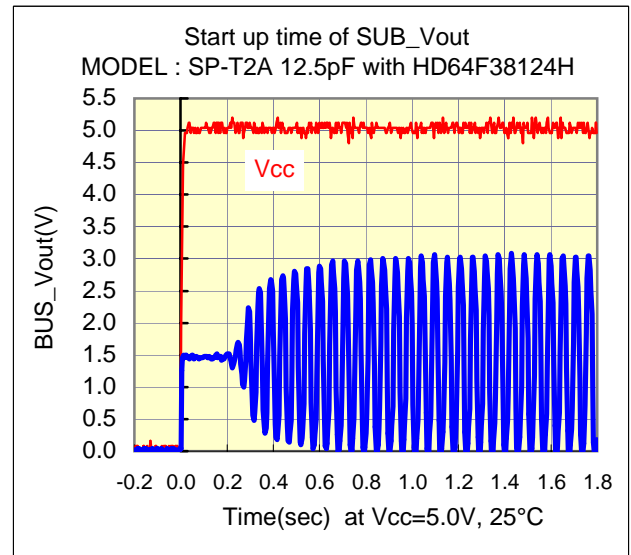
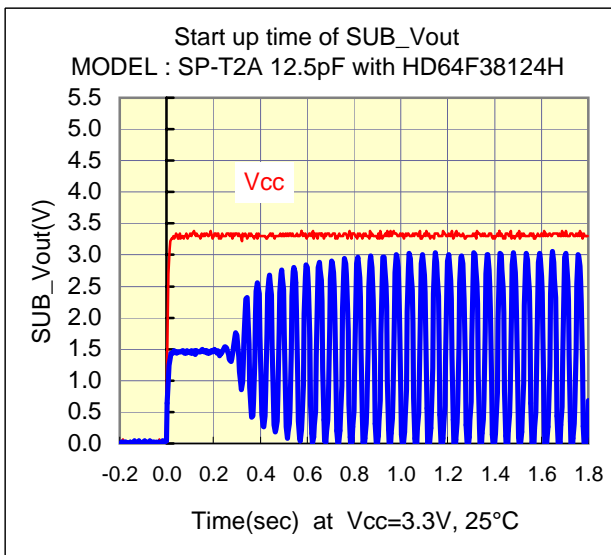
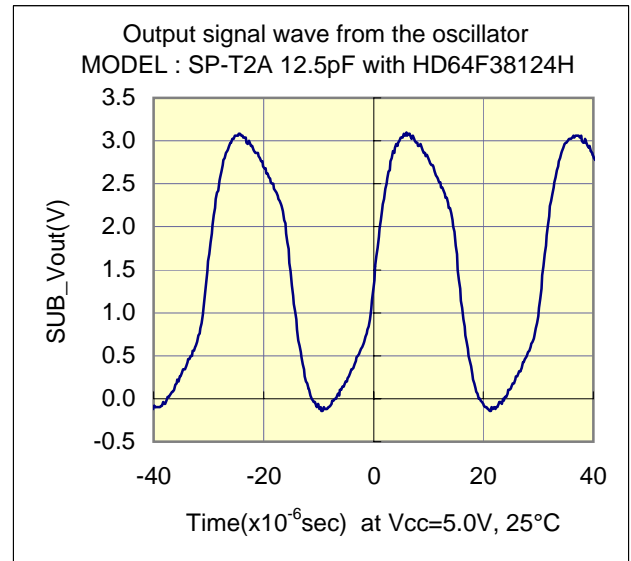
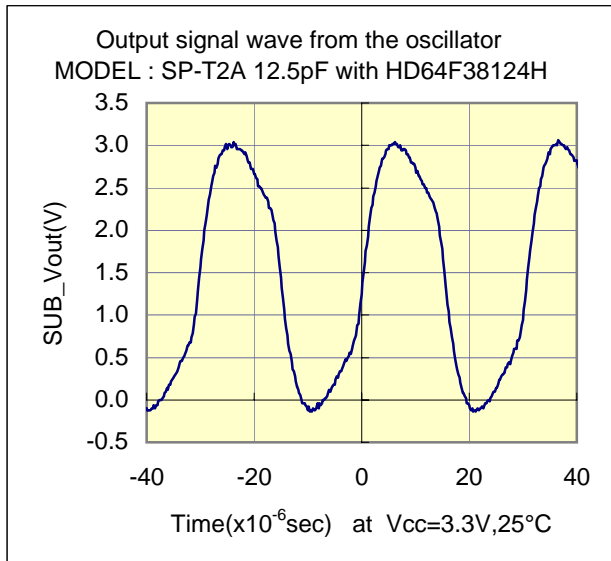

Evaluation of Subsystem Clock Oscillation Circuit

[HD64F38124H-80A] QFP(14x14) 0.65mm pitch

Measurement conditions : 5.0V , 3.3V



Test Data : Temperature characteristics

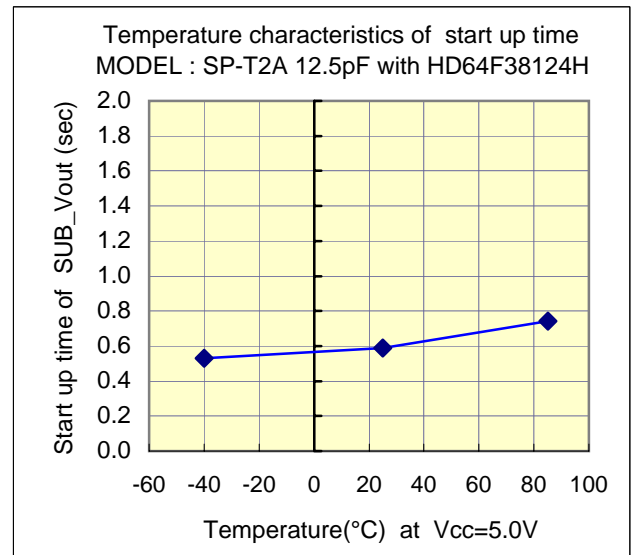
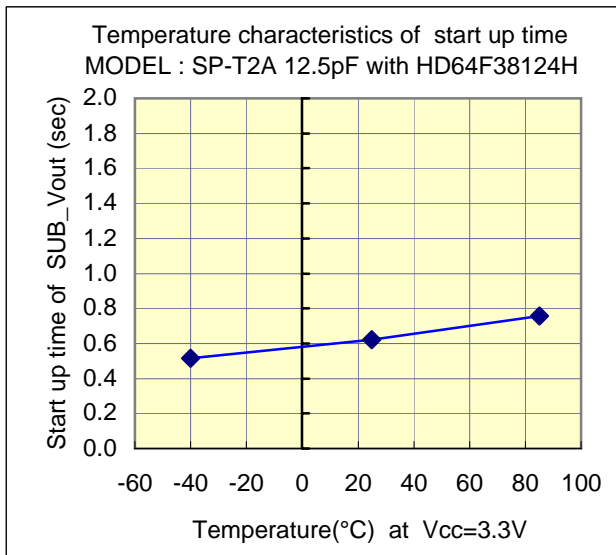
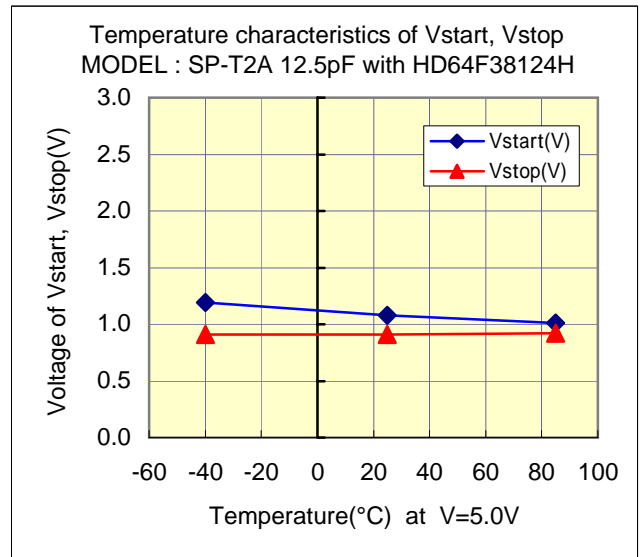
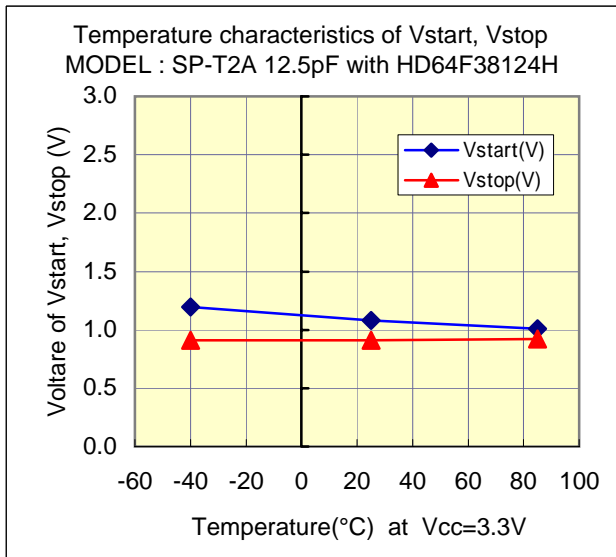
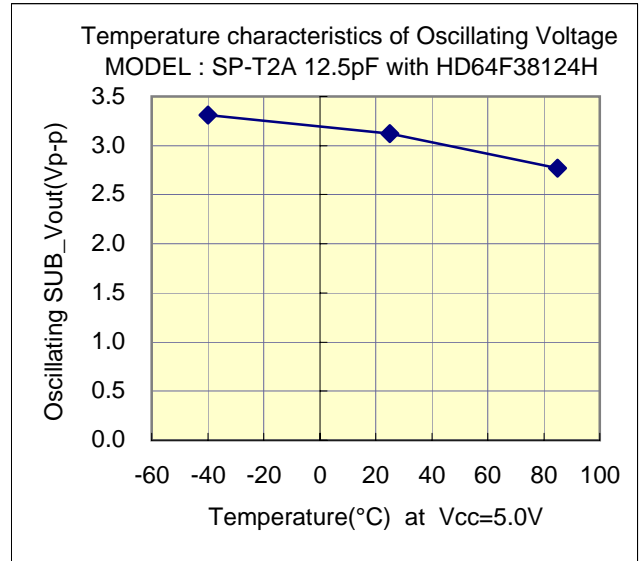
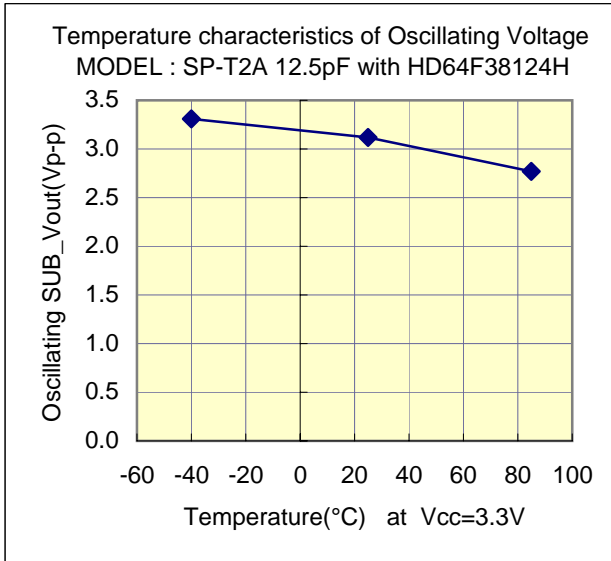

Evaluation of Subsystem Clock Oscillation Circuit

[HD64F38124H-80A] QFP(14x14) 0.65mm pitch

Measurement conditions : 5.0V , 3.3V



Referencial components layout(see Figure 1)

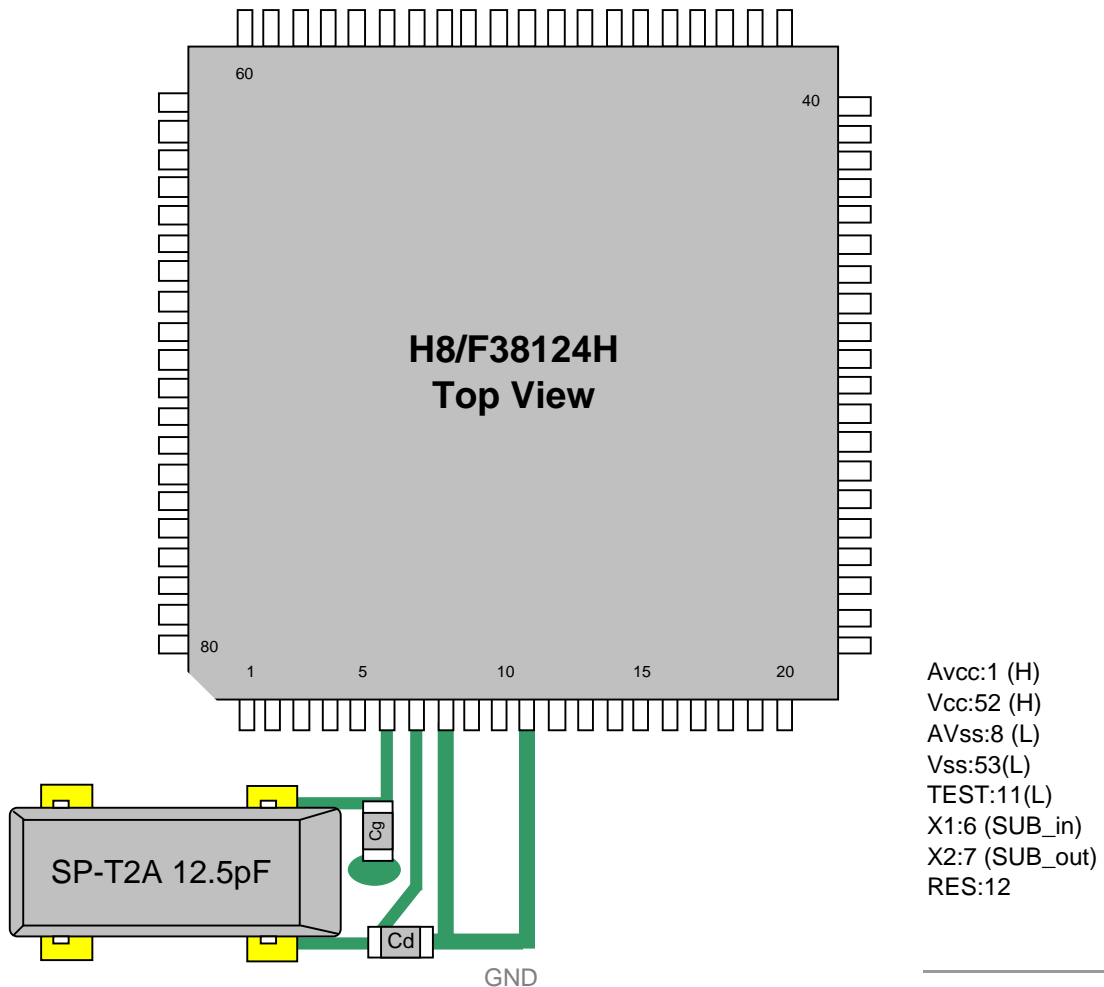

Figure 1 Referencial components layout

Notes Board Design

When using a crystal resonator, place the resonator and its load capacitors as close as possible to SUB_in and SUB_out pins.

Other signal lines should be routed away from the resonator circuit to prevent induction from interfering with correct oscillation (see figure 2).

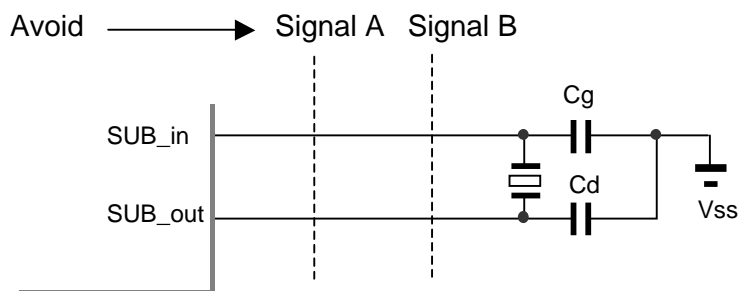

Figure 2 Example of Incorrect Board Design

Evaluation of Subsystem Clock Oscillation Circuit

[HD64F38124H-80A] QFP(14x14) 0.65mm pitch

Measurement conditions : 5.0V , 3.3V



[Evaluation Sample : SP-T2A 12.5pF at 25°C]

SAMPLE	No.	CL(pF)	Fo(Hz)	fr(Hz)	R1(kohm)	Co(pF)	C1(fF)	Q(k)
SP-T2A 12.5pF	1	12.5	32767.93	32765.40	24.4	0.96	2.078	95.9
	2	12.5	32767.82	32765.29	21.7	0.96	2.078	107.8
	3	12.5	32768.02	32765.49	19.2	0.96	2.078	121.8

[IC Test Data : IC samples Rd=0 ohm,Cg=20pF,Cd=20pF at 25°C]

Vcc(V)	IC samples	Fosc(Hz)	df / f(x10 ⁻⁶)	DL(x10 ⁻⁶ W)	-RL (kohm)	Vstart(V)	Ts(sec)
5.0	TYP	32767.77	-1.53	0.29	935	1.08	0.59
	W#02-049	32767.76	-1.98	0.30	935	1.18	0.55
	W#04-044	32767.75	-2.04	0.28	935	1.00	0.55
	W#07-048	32767.76	-1.95	0.29	935	1.14	0.58
	W#13-047	32767.77	-1.65	0.29	935	1.12	0.61
3.3	TYP	32767.75	-2.14	0.29	935	1.08	0.62
	W#02-049	32767.74	-2.44	0.30	935	1.18	0.57
	W#04-044	32767.74	-2.44	0.28	935	1.00	0.58
	W#07-048	32767.74	-2.38	0.29	935	1.14	0.60
	W#13-047	32767.75	-2.08	0.29	935	1.12	0.63

Remak (see figure 3)

$$F_o = f_r \times \{ C_1 / (2 \times (C_o + C_L) + 1) \} \text{ (Hz)}$$

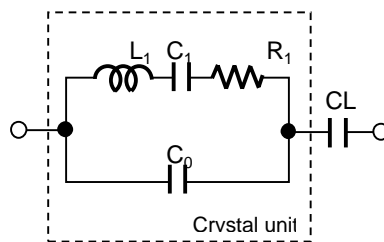

- Fo : Load resonance frequency
- fr : Resonance frequency
- R1 : Motional resistance
- C1 : Motional capacitance
- Co : Shunt capacitance
- CL : Load Capacitance

Figure 3 Equivalent circuit of crystal unit, and CL

Remak (see figure 4)

Approximate formula of the load capacitance of the circuit CL.

$$CL = C_g \times C_d / (C_g + C_d) + C_s \text{ (pF)}$$

Where Cs Stands for stray capacity of the circuit.

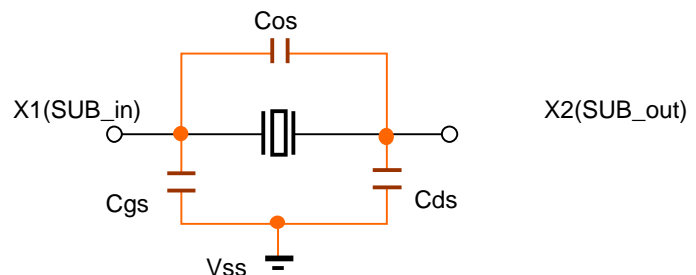

- Cos : X1_X2 Stray capacitance
- Cgs : X1_Vss Stray capacitance
- Cds : X2_Vss Stray capacitance

Figure 4 Stray capacitance Cos,Cgs,Cds of the circuit

Resonator circuit constants will differ depending on the resonator element, stray capacitance in its interconnecting circuit, and other factors. Suitable constants should be determined in consultation with the resonator element manufacturer.