

# RZ/G Verified Linux Package

## Version 3.0.7-update4

R01US0553EJ0119  
Rev. 1.19  
Jan. 30, 2026

### Release Note

#### Introduction

This release note describes the contents and important points of the RZ/G Verified Linux Package (hereinafter referred to as “VLP/G”).

Please also refer to the following documents that describe the instruction to build VLP/G and boot the evaluation boards.

- r01us0645ej0106-rz-g(Linux Start-up Guide RZG3S).pdf
- r01us0555ej0107-rz-g(Linux Start-up Guide RZG2H,M,N,E).pdf
- r01us0616ej0107-rz-g(Linux Start-up Guide RZG2L,LC,UL).pdf
- r01us0648ej0107-rz-g(Linux Start-up Guide RZG1H,M,N,E,C).pdf

#### Contents

##### Contents

<b>1. Release Items .....</b>	<b>2</b>
<b>2. Components .....</b>	<b>6</b>
<b>3. Changes .....</b>	<b>7</b>
<b>4. Restrictions .....</b>	<b>9</b>
<b>5. Notes .....</b>	<b>10</b>
<b>5.1 Notes .....</b>	<b>10</b>
<b>5.2 Memory Map .....</b>	<b>16</b>
<b>5.2.1 RZ/G3S .....</b>	<b>16</b>
<b>5.2.2 RZ/G2H, RZ/G2M, RZ/G2N, RZ/G2E .....</b>	<b>17</b>
<b>5.2.3 RZ/G2L Series.....</b>	<b>28</b>
<b>5.2.4 RZ/G1H, RZ/G1M, RZ/G1N, RZ/G1E .....</b>	<b>33</b>
<b>6. Revision History .....</b>	<b>38</b>
<b>Website and Support.....</b>	<b>39</b>

## 1. Release Items

- **Name and version**

RZ/G Verified Linux Package

Version 3.0.7-update4 (hereinafter referred to as “VLP/G v3.0.7-update4”)

- **Distribution method**

Please visit the site below and create an account to download the packages. This site is for the entire RZ Family which includes the RZ/G series. Basic packages of VLP/G v3.0.7-update4 which are listed in Table 2 can be downloaded.

RZ Family:

<https://www.renesas.com/products/microcontrollers-microprocessors/rz-arm-based-high-end-32-64-bit-mpus>

You can also download the basic packages of VLP/G v3.0.7-update4 which are listed in Table 2 from the site below.

RZ/G Verified Linux Package [5.10-CIP]:

<https://www.renesas.com/us/en/products/microcontrollers-microprocessors/rz-mpus/rzg-linux-platform/rzg-marketplace/verified-linux-package/rzg-verified-linux-package>

- **Target boards**

The target boards of this VLP are as below table.

**Table 1. Target board list**

Device	Evaluation Board
<b>RZ/G3S</b>	RZ/G3S Evaluation Board Kit. This kit includes the boards below: <ul style="list-style-type: none"> <li>- RZ/G3S SMARC Module Board (P/N: RTK9845S33C01000BE)</li> <li>- RZ SMARC Series Carrier Board (P/N: RTKSMCBB2B01000BE)</li> </ul>
<b>RZ/G2L</b>	RZ/G2L Evaluation Board Kit PMIC version. This kit includes the boards below: <ul style="list-style-type: none"> <li>- RZ/G2L SMARC Module Board v2.1</li> <li>- RZ SMARC Series Carrier Board v4.0</li> </ul>
<b>RZ/G2LC</b>	RZ/G2LC Evaluation Board Kit. This kit includes the boards below: <ul style="list-style-type: none"> <li>- RZ/G2LC SMARC Module Board v1.0</li> <li>- RZ SMARC Series Carrier Board v4.0</li> </ul>
<b>RZ/G2UL</b>	RZ/G2UL Evaluation Board Kit. This kit includes the boards below: <ul style="list-style-type: none"> <li>- RZ/G2UL SMARC Module Board v1.0</li> <li>- RZ SMARC Series Carrier Board v4.0</li> </ul>
<b>RZ/G2H</b> <b>RZ/G2M</b> <b>RZ/G2N</b> <b>RZ/G2E</b>	<ul style="list-style-type: none"> <li>- Hoperun Technology HiHope RZ/G2H platform (hihope-rzg2h) Rev 4.0</li> <li>- Hoperun Technology HiHope RZ/G2M platform (hihope-rzg2m) Rev 4.0 (*1)</li> <li>- Hoperun Technology HiHope RZ/G2N platform (hihope-rzg2n) Rev 4.0</li> <li>- Silicon Linux RZ/G2E evaluation kit (ek874) Rev E</li> </ul> <p>(*1) There are 2 versions of RZ/G2M LSI devices. There are versions 3.0 and 1.3. (hereinafter referred to as “RZ/G2M v3.0” and “RZ/G2M v1.3”).</p>
<b>RZ/G1H</b> <b>RZ/G1M</b> <b>RZ/G1N</b> <b>RZ/G1E</b>	<ul style="list-style-type: none"> <li>- iWave RZ/G1H-PF Qseven Development Platform R2.1, R4.0</li> <li>- iWave RZ/G1M-PF Qseven Development Platform R2.0, R5.0</li> <li>- iWave RZ/G1N-PF Qseven Development Platform R3.4</li> <li>- iWave RZ/G1E-PF SODIMM Development Platform R3.1, R4.0</li> </ul>

- **Build Environment**

Linux Host PC

- OS: Ubuntu 22.04 LTS (64 bit OS must be used.)
- 22.04 inside a docker container also OK.
- 200GB free space on HDD or SSD is necessary. (\*)
- (\*) The necessary free space

Note) Please note that building VLP fails when using Ubuntu 24.04.

- **Verified functions**

Linux VLP

- Linux Kernel
- Linux Drivers
- Graphics Libraries
- Codec Libraries

GUI Framework

- Qt (LGPL version)

- **File contents**

VLP/G is delivered by the files listed in Table 2.

**Table 2. RZ/G Verified Linux Package**

**Basic files of VLP/G v3.0.7-update4**

File	Description
RTK0EF0045Z0021AZJ-v3.0.7-update4.zip (*1)	Verified Linux Package. This file includes the <b>Yocto recipe packages</b> and the necessary documents.
rzg_vlp_v3.0.7.tar.gz	<b>Yocto recipe packages</b>
r01us0553ej0119-rz-g(Release Note).pdf	This document
r01us0645ej0106-rz-g3s(Linux Start-up Guide RZG3S).pdf	Documents describing building instruction, booting method and the required settings of bootloader for <b>RZ/G3S</b> .
r01us0555ej0107-rz-g(Linux Start-up Guide RZG2H,M,N,E).pdf	Documents describing booting method and the required settings of bootloader for <b>RZ/G2H, RZ/G2M, RZ/G2N, and RZ/G2E</b> .
r01us0616ej0107-rz-g(Linux Start-up Guide RZG2L,LC,UL).pdf	Documents describing booting methods and the required settings of bootloader for <b>RZ/G2L, RZ/G2LC, and RZ/G2UL</b> .
r01us0648ej0107-rz-g(Linux Start-up Guide RZG1H,M,N,E).pdf	Documents describing booting method and the required settings of bootloader for <b>RZ/G1H, RZ/G1M, RZ/G1N, and RZ/G1E</b> .
vlp_g_v3.0.7-update4_patches.zip	Patch files to update some bugs. See the "5. Notes" section. This file is optional.
oss_pkg_rzg_v3.0.7.7z (*1)	Open source software packages <b>See the Note below before you download.</b>

(\*1) These packages are provided "AS IS" with no warranty and the license which is described in the source code. Please check the contents of the license, then consider the applicability to the product carefully.

Note) The open-source software (OSS) packages contain all the relevant source code files. These are the same versions of OSS that was used when VLP/G was verified. Downloading a using this large OSS package file (oss\_pkg\_rzg\_xxx.7z) is not mandatory if your build PC is connected to the Internet and can directly download the individual source code packages listed in the Yocto recipes. However, if your build PC is not connected to the Internet, this OSS package file contains all the source packages required by the Yocto build.

Open-source software packages are required for an “offline” environment. The word “offline” means an isolated environment which does not connect to any network. VLP/G can always build images in this “offline” environment by using these packages without affected from changes of original repositories of OSSs. Also, this “offline” environment always reproduces the same images as the images which were verified by Renesas. Note that if you build without using open-source software packages, there are possibilities to use different source codes than Renesas used due to the implicit changes of the repositories of OSSs.

Most bootable images that VLP/G supports can be built on an “offline” environment. Please refer to the documents of “Linux\_StartUp\_Guide”.

#### Optional packages (\*1)

	<b>File</b> (“XX” is replaced by “EN” or “JP”.)	<b>Description</b>
RZ MPU Graphics Library	RTK0EF0045Z14001ZJ-v3.1.2.3_rzg_XX.zip (Unrestricted version)	For <b>RZ/G2L</b> and <b>RZ/G2LC</b> . This provides graphics function compliant with the OpenGL ES standard.
RZ MPU Video Codec Library	RTK0EF0045Z16001ZJ-v3.1.3.0_rzg_XX.zip (Unrestricted version)	RZ MPU Video Codec Library for <b>RZ/G2L</b> .
Multimedia Packages for RZ/G2	RTK0EF0045Z0022AZJ-v1.0.2_XX.zip (Evaluation version) RTK0EF0045Z0023AZJ-v1.0.2_XX.zip (Unrestricted version)	Multimedia Packages for <b>RZ/G2H,M,N,E</b> . This includes the graphics library and the video codec library.
Multimedia Packages for RZ/G1	RTK0EF0045Z0026AZJ_v3.5.0.1_XX.zip (Evaluation version) RTK0EF0045Z0027AZJ_v3.5.0.1_XX.zip (Unrestricted version)	Multimedia Packages for <b>RZ/G1H,M,N,E</b> . This includes the graphics library and the video codec library.

#### (\*1) Evaluation vs Unrestricted Version

There are two release versions: Evaluation and Unrestricted. This is for RZ/G2H,M,N,E and RZ/G1H,M,N,E. Please note that both packages have the same exact functionality. The only difference is that when you execute an application that uses the evaluation version of the libraries, operation will automatically be stopped after a few hours. The unrestricted version does not have this time limitation. To acquire the unrestricted version, please check the optional packages in the Renesas web below.

RZ/G Verified Linux Package [5.10-CIP]:

<https://www.renesas.com/us/en/products/microcontrollers-microprocessors/rz-mpus/rzg-linux-platform/rzg-marketplace/verified-linux-package/rzg-verified-linux-package>

**Additional packages**

<b>File</b>	<b>Description</b>
RTK0EF0045Z96001ZJ-v3.0.1.zip	BSP Manual Set for RZ/G3S
RTK0EF0045Z9006AZJ-v4.0.1.zip	BSP Manual Set for RZ/G2L, RZ/G2LC, RZ/G2UL, RZ/Five, and RZ/V2L.
RTK0EF0045Z9002AZJ-v3.0.3.zip	BSP Manual Set for RZ/G2H, RZ/G2M, RZ/G2N, and RZ/G2E.
RTK0EF0045Z9000AZJ-v3.0.0.zip	BSP Manual Set for RZ/G1H, RZ/G1M, RZ/G1N, and RZ/G1E.

Note) Detailed information regarding the configuration (Device tree) and usage of the device drivers contained in this VLP/G can be downloaded from Renesas.com. Please download the "BSP Manual Set".

Download Site:

RZ/G Verified Linux Package [5.10-CIP]:

<https://www.renesas.com/us/en/products/microcontrollers-microprocessors/rz-mpus/rzg-linux-platform/rzg-marketplace/verified-linux-package/rzg-verified-linux-package>

## 2. Components

The components which are commonly used in this release are listed in Table 3. Please also refer to the manifest file for details. The manifest file is created to follow path after building the images:

```
$WORK/build/tmp/deploy/images/<board>/core-image-<image-name>-<board>.manifest
```

Note) <board> is refer to Linux Start-up Guide of each device.  
<image-name> is minimal, bsp, weston or qt.

Please refer to the instructions in Linux Start-up Guide of each device.

**Table 3. Versions of commonly used components**

Components	VLP/G v3.0.6-update3 For RZ/G Series	VLP/G v3.0.7 For RZ/G Series	VLP/G v3.0.7-update[2,3,4] For RZ/G Series
Linux kernel	5.10.201-cip41	5.10.229-cip54	5.10.229-cip54
gcc	8.3.0 (Arm GCC 8.3-2019.03)	8.3.0 (Arm GCC 8.3-2019.03)	8.3.0 (Arm GCC 8.3-2019.03)
glibc	2.28	2.28(-10+deb10u4)	2.28(-10+deb10u5) <sup>(*)2</sup>
busybox	1.30.1	1.30.1(-4)	1.30.1(-4+deb10u1) <sup>(*)3</sup>
openssl	1.1.1n	1.1.1n(-0+deb10u6)	1.1.1n(-0+deb10u7) <sup>(*)3</sup> 1.1.1n(-0+deb10u8) <sup>(*)4</sup>
gststreamer1.0	1.16.3	1.16.3	1.16.3
wayland	1.18.0	1.18.0	1.18.0
weston	8.0.0	8.0.0	8.0.0
python3	3.8.18	3.8.18	3.8.18
qt (LGPL version) <sup>(*)1</sup>	5.6.3	5.6.3	5.6.3
docker	19.03.8-ce	19.03.8-ce	19.03.8-ce

(\*)1 New versions such as Qt6.2.4 are also known to work. Please contact The Qt Company for instructions and support.

(\*)2 Addressed security vulnerability CVE-2025-4802.

(\*)3 VLP/G v3.0.7-update3.

(\*)4 VLP/G v3.0.7-update4.

### 3. Changes

The following table lists the changes from the previous version.

**Table 4. Changes**

**Changes from VLP/Gv3.0.6-update3 to VLP/Gv3.0.7**

Features	Description
Yocto recipe	<ul style="list-style-type: none"> <li>- Poky: update to dunfell v23.0.33 (previous version is v23.0.31).</li> <li>- meta-openembedded: update to the latest commit.</li> <li>- RZ/G3S WIC image: update to eSD boot.</li> </ul>
Kernel	Update the kernel version to v5.10.229-cip54 and v5.10.229-cip54-rt23.
I3C Driver	Add Suspend to RAM (S2R) support.
MTU3 Driver	Enable output pins for channel 4 and 7. Add Suspend to RAM (S2R) support.
RIIC Driver	Add slave mode support, add bus recovery implementation for G2L Series.
SSI Driver	Terminate DMA descriptor if stream is not running, workaround for full duplex TX/RX alignment; add S2R implementation.
SPDIF Driver	Add DMAC, full duplex, and S2R support.
SYSC Driver	Add sysc-con for interconnection support.
Versa3-clock	Add support for 5L35023 variant.
RZ MPU Graphics Library (RZ/G2L, LC)	This release includes some specification updates.
RZ MPU Graphics Video Codec Library (RZ/G2L)	This release includes some bug fixes.

**Changes from VLP/Gv3.0.7 to VLP/Gv3.0.7-update2**

Features	Description
Kernel	This release includes several minor kernel fixes, as listed in 5.1 Notes "To update linux-renesas".
U-boot	Update vmmc and vqmmc settings for eSD mode. Configure U-Boot to set a random MAC address.
CVE-2024-53104	Fix out-of-bounds write by skipping UVC_VS_UNDEFINED frame parsing in uvc_parse_format (media: uvcvideo).
CVE-2025-4802	This release includes the patch for the glibc vulnerability.
glib-2.0	Updated to glib2.0_2.58.3-2+deb10u8.
multimedia	Update runtime dependencies, fix MMNGR issues, and add GRAY10_LE64 support to GStreamer.

**Changes of VLP/Gv3.0.7-update2, VLP/Gv3.0.7-update3**

Features	Description
attr, binutils, busybox, coreutils, gcc-8, gnupg2, gzip, kbd, libassuan,	Switch to the ELTS mirror to prevent removal from the Debian Buster mirror: attr, coreutils, gcc-8, gnupg2, gzip, kbd, libassuan, libgcrypt20, libunistring, nss, perl, pkg-config, pseudo, quilt

libcrypt20, libunistring, nss, openssh, openssl, perl, pkg-config, pseudo, quilt	- Upgraded packages: binutils 2.31.1-16 -> 2.31.1-16+deb10u1 busybox 1.30.1-4 -> 1.30.1-4+deb10u1 openssh 7.9p1-10+deb10u2 -> 7.9p1-10+deb10u5 openssl 1.1.1n-0+deb10u6 -> 1.1.1n-0+deb10u7
SSI Driver	Fix random recording failures in full-duplex communication mode (RZ/G2L Series and RZ/G3S).
PCIe Driver	Enables NVMe PCIe support (RZ/G3S only).

#### Changes of VLP/Gv3.0.7-update3, VLP/Gv3.0.7-update4

Features	Description
openssl, glib-2.0	- Upgraded packages: openssl 1.1.1n-0+deb10u7 -> 1.1.1n-0+deb10u8 glib-2.0 2.58.3-2+deb10u8 -> 2.58.3-2+deb10u9

## 4. Restrictions

### (1) USB camera 3.0

RZ/G2E cannot stream with higher resolution than Full HD when you use a camera with USB 3.0.

### (2) CSI40

Disable CSI40 in RZ/G2H, N and G2M v3.0 by default due to SW limitation.

### (3) Wifi and Bluetooth

Low performance while using 2.4GHz Wifi/Bluetooth and USB 3.0 device in Hihope RZ/G2H, M, and N at the same time due to noise. If using USB3.0 device, should connect to 5GHz Wifi network.

Wifi/Bluetooth function on the iWave RZ/G1E rev4.0 board has not been supported.

## 5. Notes

### 5.1 Notes

Check the following patches, select, and apply to your build environment if needed. After that, build in the “**online**” environment. This step is required before executing the bitbake command. Refer to the section below in the “Linux Start-up Guide” for more information.

```
$ cd ~/rzg_vlp_${PACKAGE_VERSION}          #(e.g., PACKAGE_VERSION=v3.0.7)
$ unzip RTK0EF0045Z0021AZJ-v3.0.7-update4.zip \
"RTK0EF0045Z0021AZJ-v3.0.7-update4/vlp_g_v3.0.7-update4_patches.zip"
$ unzip RTK0EF0045Z0021AZJ-v3.0.7-update4/vlp_g_v3.0.7-update4_patches.zip -d extra
```

The following files and directories will be extracted into the `~/rzg_vlp_${PACKAGE_VERSION}/extra` folder:

```
|—— 0001-meta-rz-common-recipes-core-debian-glibc-fix-CVE-2025-4802.patch
|—— 0002-meta-rz-common-glib2.0-update-to-2.58.3-2-deb10u8.patch
|—— 0003-rz-common-recipes-debian-buster-switch-some-packages.patch
|—— 0004-rz-common-recipes-debian-buster-glib-2.0-openssl-upd.patch
|—— 0001-mmngr-vspmif-gstreamer-Update-for-BSP-3.0.7-update2.patch
|—— linux-renesas
|   |—— 0001-arm64-dts-renesas-Add-POE3-setting-for-RZ-G2LC-SMARC.patch
|   |—— 0002-driver-i2c-busses-i2c-riic-Improve-I2C-slave-mode.patch
|   |—— 0003-media-uvcvideo-Skip-parsing-frames-of-type-UVC_VS_UN.patch
|   |—— 0004-mmc-host-renesas_sdhi_core-Fix-delayed-eMMC-boot.patch
|   |—— 0005-drm-rz-du-Support-panels-connected-directly-to-the-D.patch
|   |—— 0006-driver-i2c-busses-i2c-riic-Fix-issue-wrong-bit-in-at.patch
|   |—— 0007-arm64-dts-renesas-Add-mmc0-1-aliases-for-all-RZ-V-G-.patch
|   |—— 0008-pinctrl-renesas-rzg2l-Add-output-enable-for-remained.patch
|   |—— 0009-arm64-dts-renesas-rzg2l-lc-ul-smarc-som-update-ethe.patch
|   |—— 0010-pci-pcie-rzv2m-host-Update-DEVICE-ID-based-on-SoCs.patch
|   |—— 0011-drm-renesas-rz-du-Drop-bpp-variable-from-struct-rzg2.patch
|   |—— 0012-drm-renesas-Extend-RZ-G2L-supported-KMS-formats.patch
|   |—— 0013-drm-renesas-Add-zpos-alpha-and-blend-properties-to-R.patch
|   |—— 0014-drm-panel-Add-prepare_prev_first-flag-to-drm_panel.patch
|   |—— 0015-drm-bridge-Introduce-pre_enable_prev_first-to-alter-.patch
|   |—— 0016-drm-renesas-rz-du-Fix-warning-when-making-kernel.patch
|   |—— 0017-drm-renesas-rz-du-Add-atomic_pre_enable.patch
|   |—— 0018-drm-renesas-rz-du-Implement-MIPI-DSI-host-transfers.patch
|   |—— 0019-counter-rz-mtu3-cnt-Fix-warning-when-CONFIG_PM_SLEEP.patch
|   |—— 0020-clk-renesas-rzg2l-cpg-Change-parent-target-rate-abov.patch
|   |—— 0021-irqchip-irq-renesas-rzg2l-Save-restore-NITSR-TITSR-T.patch
```

```

| |—— 0022-pinctrl-renesas-rzg2l-Save-restore-ISEL-registers-wh.patch
| |—— 0023-driver-i2c-busses-i2c-riic-Fix-issue-can-t-set-value.patch
| |—— 0024-arm64-configs-defconfig-Enable-NVMe-PCIe-support.patch
| |—— 0025-Revert-sound-rz-ssi-workaround-to-set-TX-and-RX-at-t.patch
| |—— 0026-sound-soc-rz-ssi-Avoid-enabling-TEN-and-REN-bits-bef.patch
| |—— 0027-sound-soc-rz-ssi-Remove-checking-valid-of-sample_wid.patch
| |—— 0028-i3c-renesas-i3c-master-Correct-DEV_INDEX-when-DAA-af.patch
| |—— 0029-i3c-renesas-i3c-master-Avoid-use-after-free-in-renes.patch
| |—— 0030-i3c-renesas-i3c-master-Add-odd-parity-bit-when-SETDA.patch
|—— u-boot
|—— 0001-configs-remove-unzip-command-for-all-Renesas-RZ-Smar.patch
|—— 0002-board-rzg2l-dev-Update-change-vmmc-and-vqmmc-for-eSD.patch
|—— 0003-board-rzg2lc-dev-Update-change-vmmc-and-vqmmc-for-eS.patch
|—— 0004-board-rzv2l-dev-Update-change-vmmc-and-vqmmc-for-eSD.patch
|—— 0005-configs-smarc-rz-g2l-g2lc-g2ul-v2l-change-CONFIG_ENV.patch
|—— 0006-configs-Enable-CONFIG_NET_RANDOM_ETHADDR-as-default.patch

```

Note) This update includes minor fixes. It is strongly recommended to apply all patches in the specified order to avoid conflicts, unintended errors, and to achieve the best possible results.

#### (1) To patch CVE-2025-4802 vulnerability (all products)

This patch addresses CVE-2025-4802, a vulnerability in glibc (v2.27–2.38) related to untrusted `LD_LIBRARY_PATH` usage in statically compiled `setuid` binaries that invoke `dlopen`.

→ Full details: <https://nvd.nist.gov/vuln/detail/CVE-2025-4802>

The patch applies to both `recipes-core` and `recipes-debian`:

For `recipes-debian`:

- buster: 2.28-10+deb10u5
- bullseye: 2.31-13+deb11u13

For `recipes-core`, the upstream patches have been backported to support Poky.

```

$ cd ~/rzg_vlp_${PACKAGE_VERSION}/meta-renesas
$ patch -p1 < ../extra/0001-meta-rz-common-recipes-core-debian-glibc-fix-CVE-2025\
-4802.patch

```

**(2) To update Open-source software (OSS) packages**

It has been observed that Debian Mirror for Buster has recently started deprecating these packages on their mirror. As a result, this update switches to the ELTS mirror provided by <https://www.freexian.com/> to ensure the packages are successfully fetched when building the online environment. Without the Open-Source Software packages (oss\_pkg\_rzg\_v3.0.7.7z), the build process will fail. To build successfully without them, apply the following patches.

```
$ cd ~/rzg_vlp_${PACKAGE_VERSION}/meta-renesas
$ patch -p1 < ../extra/0002-meta-rz-common-glib2.0-update-to-2.58.3-2-deb10u8.patch
$ patch -p1 < ../extra/0003-rz-common-recipes-debian-buster-switch-some\
-packages.patch
$ patch -p1 < ../extra/0004-rz-common-recipes-debian-buster-glib-2.0-openssl\
-upd.patch
```

Note) The patch 0001-meta-rz-common-recipes-core-debian-glibc-fix-CVE-2025-4802.patch must be applied before performing this step to avoid build errors.

**(3) To update linux-renesas**

This vlp\_g\_v3.0.7-update4\_patches.zip package includes some patches to improve *linux-renesas*

Patch Name	Driver	Machine	Description
0001-arm64-dts-renesas-Add-POE3-setting-for-RZ-G2LC-SMARC.patch	POE3	smarc-rzg2lc	Driver improvement.
0002-driver-i2c-busses-i2c-riic-Improve-I2C-slave-mode.patch	I2C	smarc-rzg2[l,lc,ul] smarc-rzg3s	Driver improvement.
0003-media-uvcvideo-Skip-parsing-frames-of-type-UVC_VS_UN.patch	USB	All products	Fix CVE-2024-53104.
0004-mmc-host-renesas_sdhi_core-Fix-delayed-eMMC-boot.patch	SDHI	smarc-rzg2[l,lc,ul] smarc-rzg3s	Driver improvement.
0005-drm-rz-du-Support-panels-connected-directly-to-the-D.patch	DU	smarc-rzg2[l,lc,ul]	Driver improvement.
0006-driver-i2c-busses-i2c-riic-Fix-issue-wrong-bit-in-at.patch	I2C	smarc-rzg2[l,lc,ul] smarc-rzg3s	Driver improvement.
0007-arm64-dts-renesas-Add-mmc0-1-aliases-for-all-RZ-V-G-.patch	SHDI	smarc-rzg2[l,lc,ul]	Driver improvement.
0008-pinctrl-renesas-rzg2l-Add-output-enable-for-remained.patch	Pinctrl	smarc-rzg2[l,lc,ul]	Driver improvement.
0009-arm64-dts-renesas-rzg2-l-lc-ul-smarc-som-update-ethe.patch	Ethernet	smarc-rzg2[l,lc,ul]	Driver improvement.
0010-pci-pcie-rzv2m-host-Update-DEVICE-ID-based-on-SoCs.patch	-	-	Not needed for VLP/G; included for kernel alignment only.
0011-drm-renesas-rz-du-Drop-bpp-variable-from-struct-rzg2.patch	DU	smarc-rzg2[l,lc,ul]	Driver improvement.
0012-drm-renesas-Extend-RZ-G2L-supported-KMS-formats.patch	DU	smarc-rzg2[l,lc,ul]	Driver improvement.
0013-drm-renesas-Add-zpos-alpha-and-blend-properties-to-R.patch	DU	smarc-rzg2[l,lc,ul]	Driver improvement.

0014-drm-panel-Add-prepare_prev_first-flag-to-drm_panel.patch	DU	smarc-rzg2[l,lc]	Driver improvement.
0015-drm-bridge-Introduce-pre_enable_prev_first-to-alter-.patch	DU	smarc-rzg2[l,lc]	Driver improvement.
0016-drm-renesas-rz-du-Fix-warning-when-making-kernel.patch	DU	smarc-rzg2[l,lc]	Driver improvement.
0017-drm-renesas-rz-du-Add-atomic_pre_enable.patch	DU	smarc-rzg2[l,lc]	Fix bugs for MIPI-DSI DCS commands.
0018-drm-renesas-rz-du-Implement-MIPI-DSI-host-transfers.patch	DU	smarc-rzg2[l,lc]	Fix bugs for MIPI-DSI DCS commands.
0019-counter-rz-mtu3-cnt-Fix-warning-when-CONFIG_PM_SLEEP.patch	MTU3	smarc-rzg2[l,lc,ul]	Driver improvement.
0020-clk-renesas-rzg2l-cpg-Change-parent-target-rate-abov.patch	CPG	smarc-rzg2[l,lc,ul]	Driver improvement.
0021-irqchip-irq-renesas-rzg2l-Save-restore-NITSR-TITSR-T.patch	IRQ	smarc-rzg3s	Driver improvement.
0022-pinctrl-renesas-rzg2l-Save-restore-ISEL-registers-wh.patch	Pinctrl	smarc-rzg3s	Fix bugs after S2R (Suspend to RAM).
0023-driver-i2c-busses-i2c-riic-Fix-issue-can-t-set-value.patch	I2C	smarc-rzg2[l,lc,ul] smarc-rzg3s	Driver improvement.
0024-arm64-configs-defconfig-Enable-NVMe-PCle-support.patch	PICE	smarc-rzg3s	Driver improvement.
0025-Revert-sound-rz-ssi-workaround-to-set-TX-and-RX-at-t.patch	SSI	smarc-rzg2[l,lc,ul] smarc-rzg3s	Fixed full-duplex mode (1).
0026-sound-soc-rz-ssi-Avoid-enabling-TEN-and-REN-bits-bef.patch	SSI	smarc-rzg2[l,lc,ul] smarc-rzg3s	Fixed full-duplex mode (2).
0027-sound-soc-rz-ssi-Remove-checking-valid-of-sample_wid.patch	SSI	smarc-rzg2[l,lc,ul] smarc-rzg3s	Fixed full-duplex mode (3).
0028-i3c-renesas-i3c-master-Correct-DEV_INDEX-when-DAA-af.patch	I3C	smarc-rzg3s	Fix bugs after S2R (Suspend to RAM).
0029-i3c-renesas-i3c-master-Avoid-use-after-free-in-renes.patch	I3C	smarc-rzg3s	Fix bugs after S2R (Suspend to RAM).
0030-i3c-renesas-i3c-master-Add-odd-parity-bit-when-SETDA.patch	I3C	smarc-rzg3s	Fix bugs after S2R (Suspend to RAM).

Note) Apply all relevant module patches in order, from the first to the selected patch, to avoid conflicts.

To apply these patches, follow the instructions below.

```
$ cd ~/rzg_vlp_${PACKAGE_VERSION}/build
$ MACHINE=<board> bitbake linux-renesas -c devshell

# Apply {patch_name} at tmp/work-shared/<machine>/kernel-source
$ git am ~/rzg_vlp_${PACKAGE_VERSION}/extra/linux-renesas/{patch_name}
$ exit
$ MACHINE=<board> bitbake linux-renesas -C compile
```



**(4) To update u-boot**

This vlp\_g\_v3.0.7-update4\_patches.zip package includes some patches to improve *u-boot*.

Patch Name	Driver	Machine	Description
0001-configs-remove-unzip-command-for-all-Renesas-RZ-Smar.patch	Environment	smarc-rzg2[l,lc,ul]	Adjust default U-Boot environment settings.
0002-board-rzg2l-dev-Update-change-vmmc-and-vqmmc-for-eSD.patch	Environment	smarc-rzg2l	Update vmmc and vqmmc settings for eSD mode.
0003-board-rzg2lc-dev-Update-change-vmmc-and-vqmmc-for-eS.patch	Environment	smarc-rzg2lc	Update vmmc and vqmmc settings for eSD mode.
0004-board-rzv2l-dev-Update-change-vmmc-and-vqmmc-for-eSD.patch	-	-	Not needed for VLP/G; included for u-boot alignment only.
0005-configs-smarc-rz-g2l-g2lc-g2ul-v2l-change-CONFIG_ENV.patch	Environment	smarc-rzg2[l,lc,ul]	Avoid U-boot environmental conflicts when using the Security Package.
0006-configs-Enable-CONFIG_NET_RANDOM_ETHADDR-as-default.patch	Ethernet	smarc-rzg2[l,lc,ul]	Set random MAC address in U-Boot.

To apply these patches, follow the instructions below.

```
$ cd ~/rzg_vlp_${PACKAGE_VERSION}/build
$ MACHINE=<board> bitbake u-boot -c devshell
# Apply {patch_name} at
# tmp/work/<machine>-poky-linux/u-boot/1_v2021.10+gitAUTOINC+50bafef75d5-r0/git
$ git am ~/rzg_vlp_${PACKAGE_VERSION}/extra/u-boot/{patch_name}
$ exit
$ MACHINE=<board> bitbake u-boot -C compile
```

**(5) To update recipes-multimedia: {mmngr, vspmf, gstreamer}**

This patch updates runtime dependencies, includes minor fixes for MMNGR, and adds GStreamer support for GRAY10\_LE64 (corresponding to ISU\_RAW10).

```
$ cd ~/rzg_vlp_${PACKAGE_VERSION}/meta-renesas
$ patch -p1 < ../extra/0001-mmngr-vspmf-gstreamer-Update-for-BSP-3.0.7-update2.patch
```

## 5.2 Memory Map

### 5.2.1 RZ/G3S

Note)

Kernel uses 4KB page size (VA\_BITS=48) and 4 levels of translation tables.

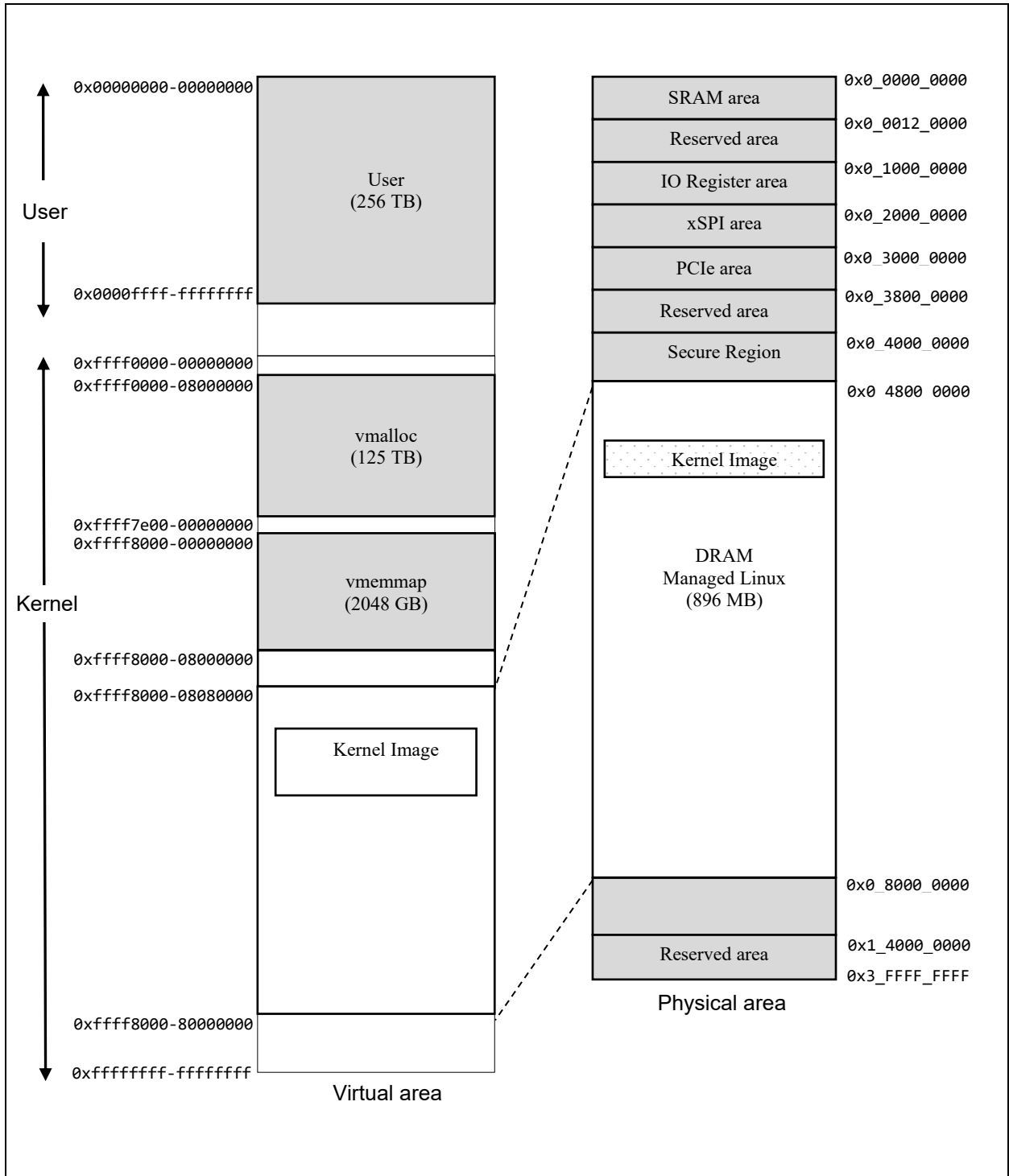

Figure 1. Memory map of kernel (RZ/G3S SMARC Evaluation Kit)

### 5.2.2 RZ/G2H, RZ/G2M, RZ/G2N, RZ/G2E

Following from Figure 2 to Figure 10 show memory map of RZ/G2[H/M/N/E] in this Linux BSP package.

Note)

- The volume of SDRAM is total:
  - 2GB (RZ/G2E System Evaluation Board EK874)
  - 4GB (RZ/G2M System Evaluation Board HiHope-RZG2M)
  - 4GB (RZ/G2N System Evaluation Board HiHope-RZG2N)
  - 4GB (RZ/G2H System Evaluation Board HiHope-RZG2H).
- 2GB from 0x00\_4000\_0000 to 0x00\_BFFF\_FFFF is a shadow area from 0x04\_0000\_0000 to 0x04\_7FFF\_FFFF.
- The following regions are used as a secure region. It doesn't allow U-Boot and kernel to access those regions.
  - 63MB from 0x00\_43F0\_0000 to 0x00\_47DF\_FFFF in SDRAM
  - 16KB from 0x00\_E630\_0000 to 0x00\_E630\_3FFF in System RAM
- **In case the configuration of BSP + 3D Graphics + Multimedia package, it doesn't allow to store any data in "CMA for Lossy comp" (default: 0x00\_5400\_0000 - 0x00\_56FF\_FFFF) region which is for media playback before kernel boots up. Any data stored in this region are read through the decompression module in AXI-Bus, so a normal data (not a decoded frame) will be corrupted.**

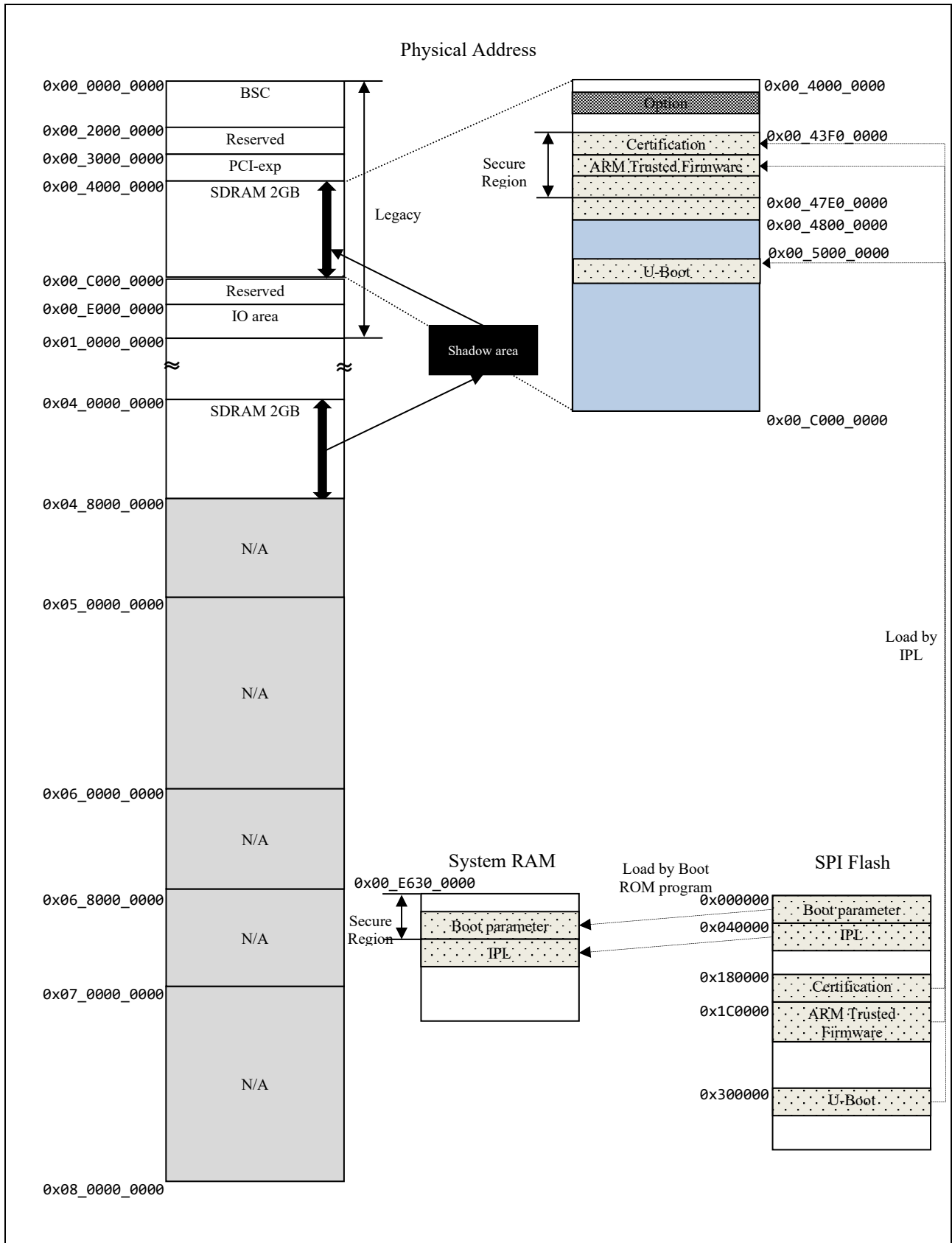

Figure 2. RZ/G2E System Evaluation Board EK874 memory map (Boot)

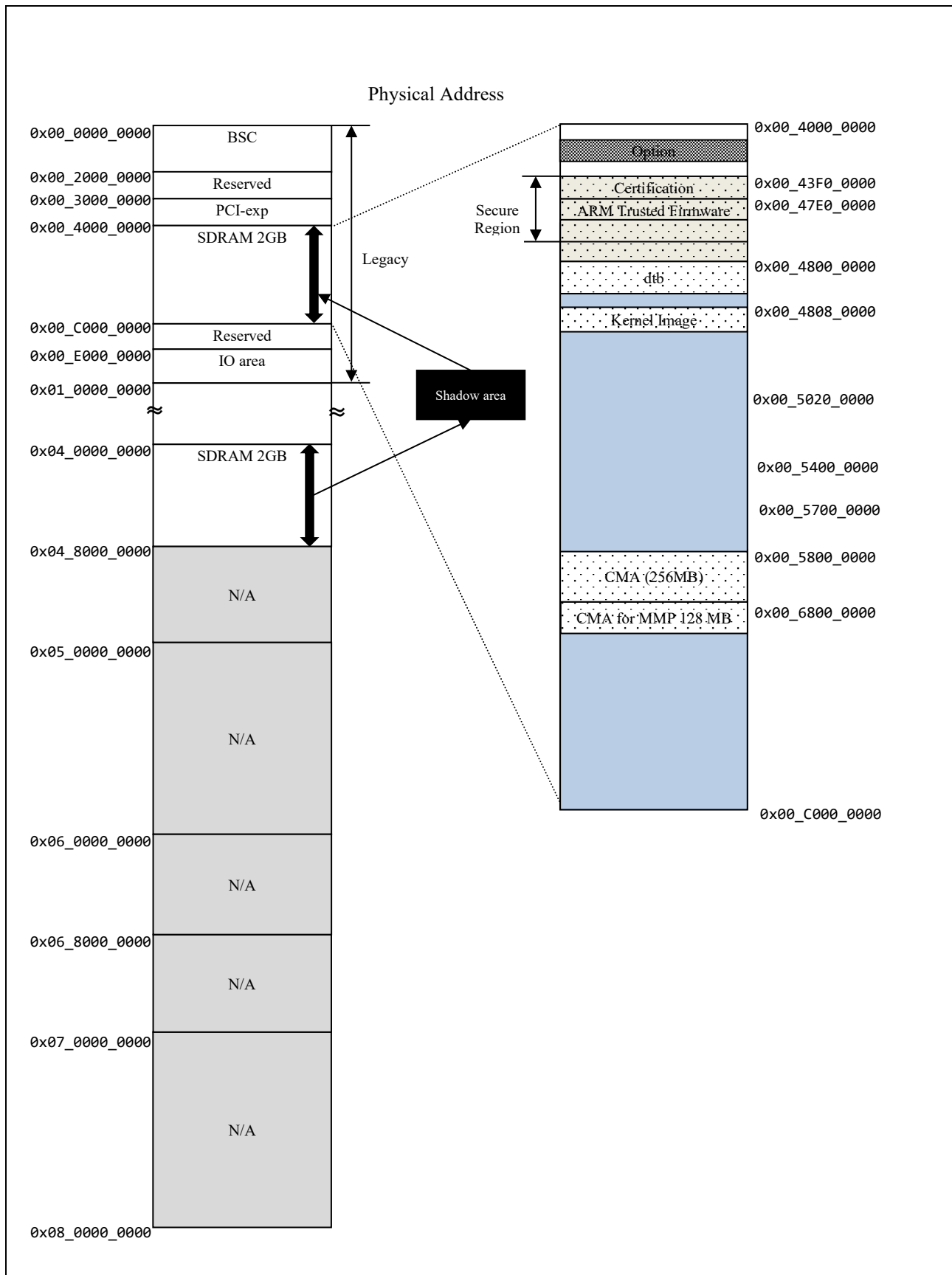

Figure 3. RZ/G2E System Evaluation Board EK874 memory map (Linux)

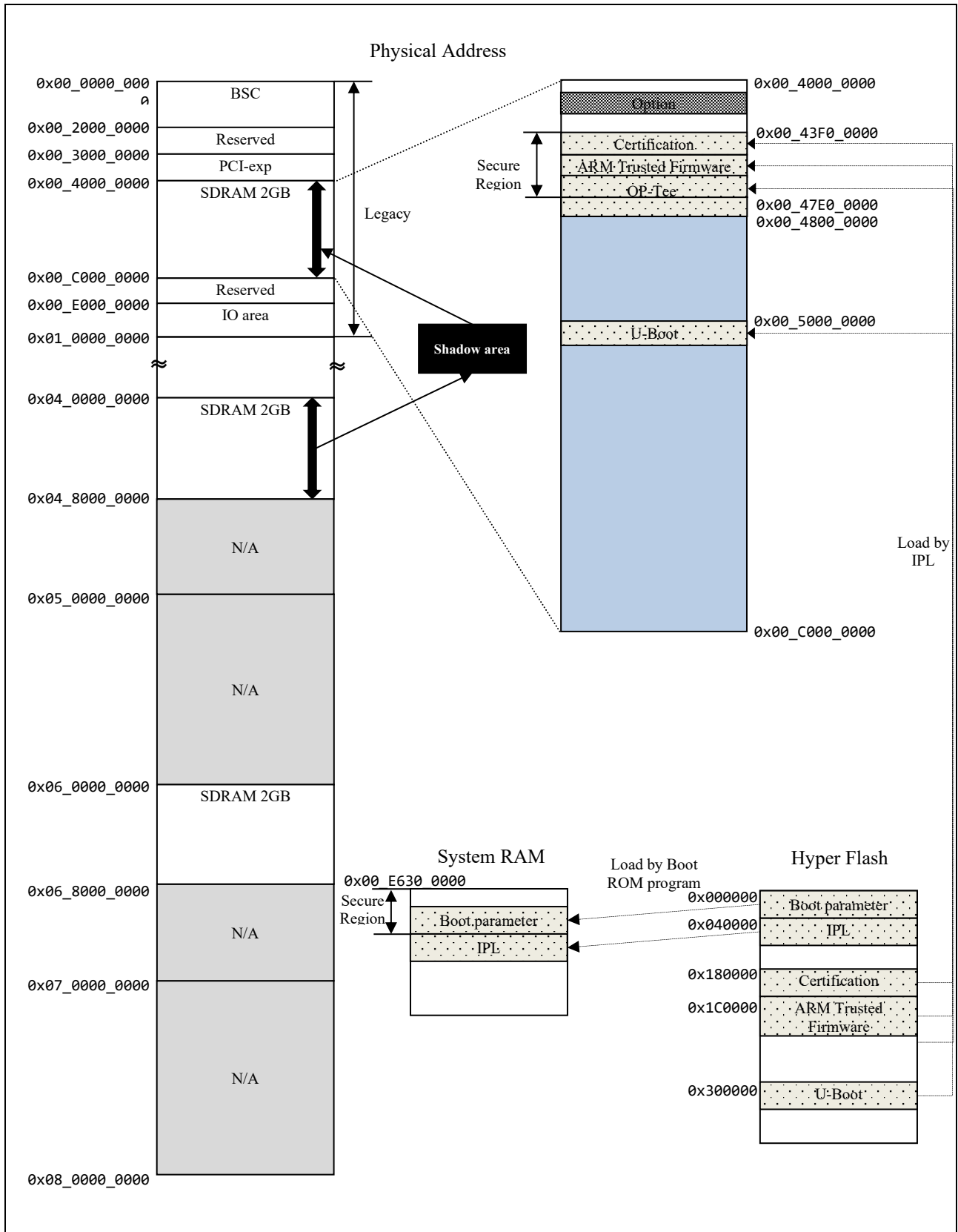

Figure 4. RZ/G2M System Evaluation Board (HIHOPE-RZG2M) memory map (Boot)

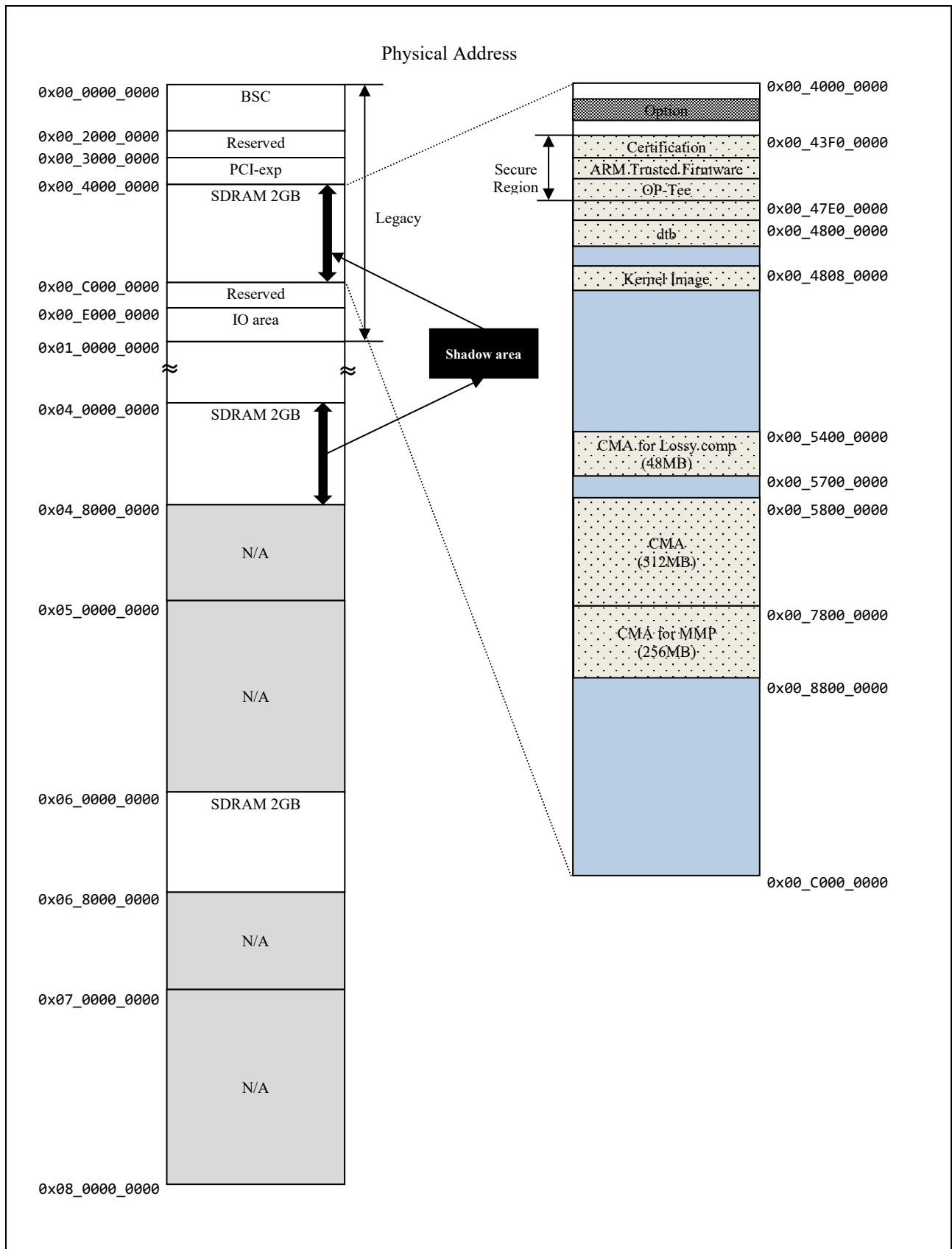

Figure 5. RZ/G2M System Evaluation Board (HiHope-RZG2M) memory map (Linux)

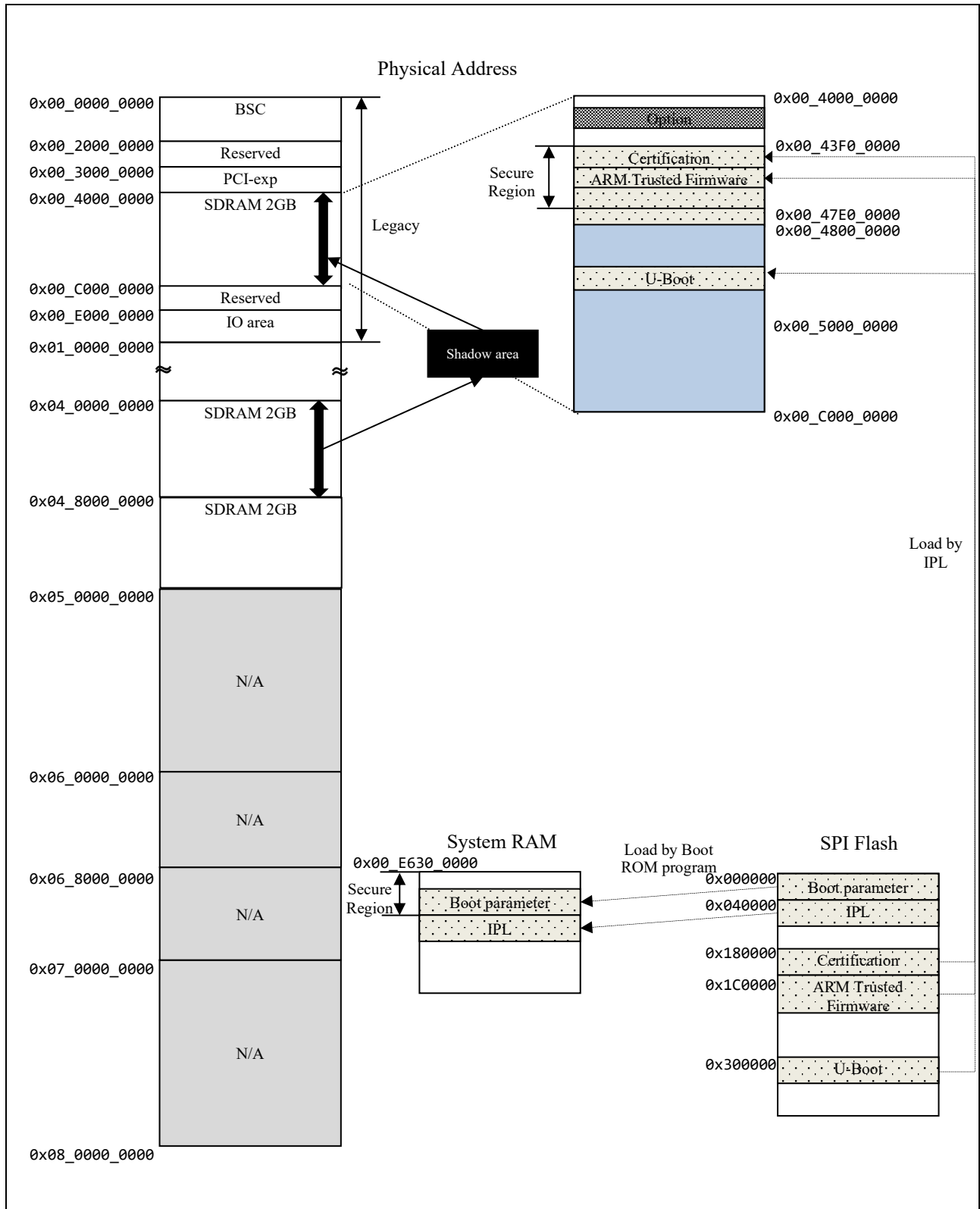

Figure 6. RZ/G2N System Evaluation Board (HiHope-RZG2N) memory map (Boot)

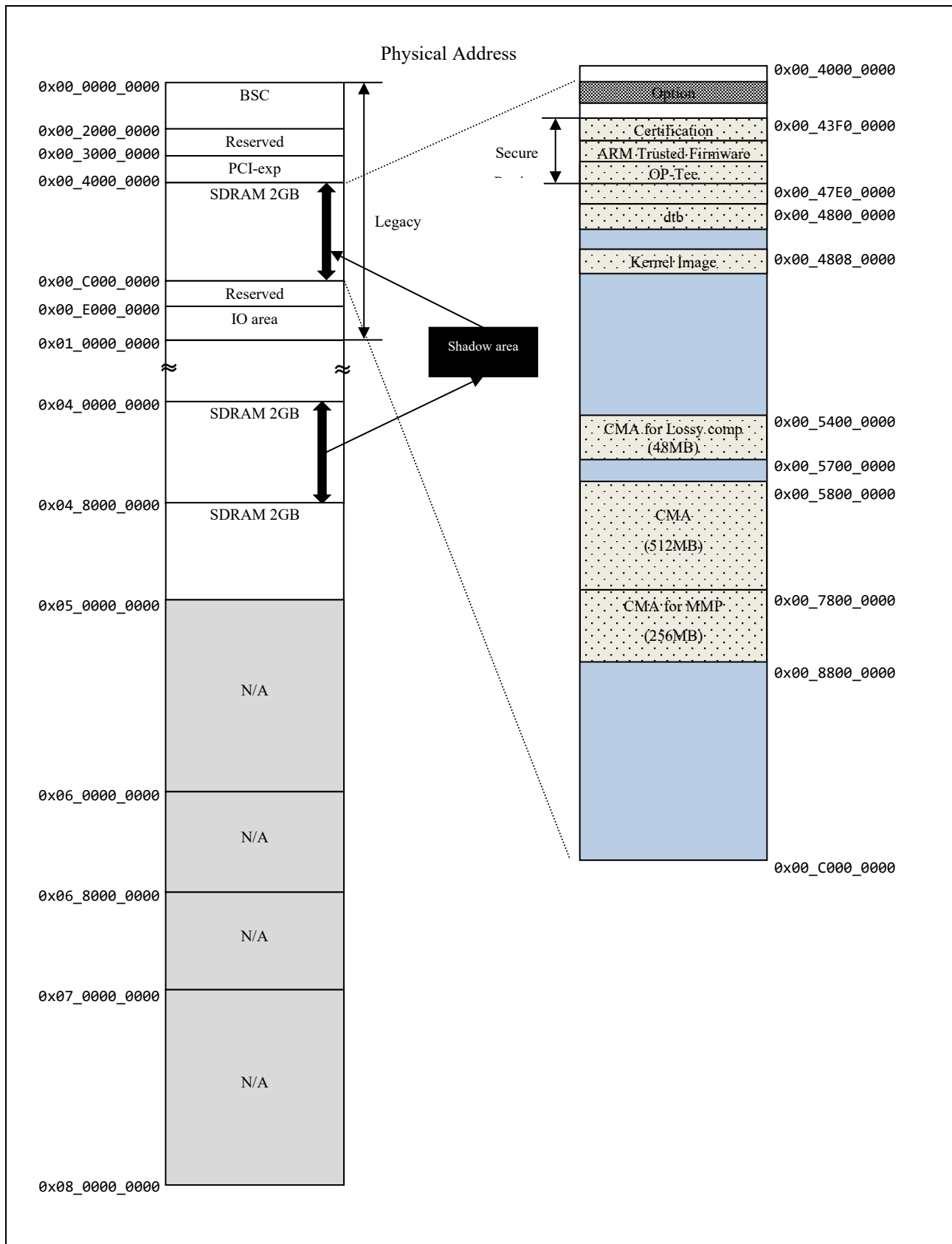

Figure 7. RZ/G2N System Evaluation Board (HiHope-RZG2N) memory map (Linux)

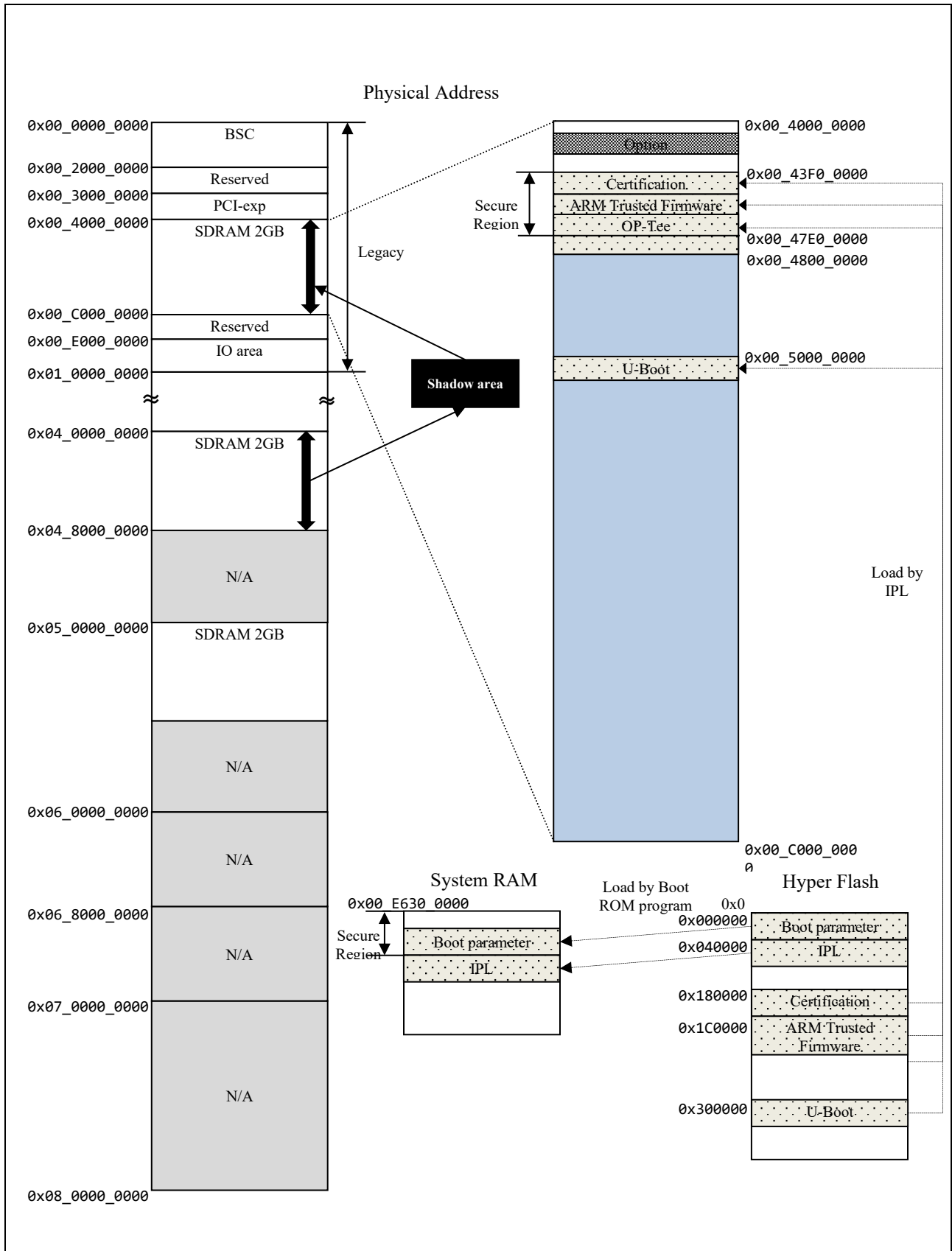

Figure 8. RZ/G2H System Evaluation Board (HIHOPE-RZG2H) memory map (Boot)

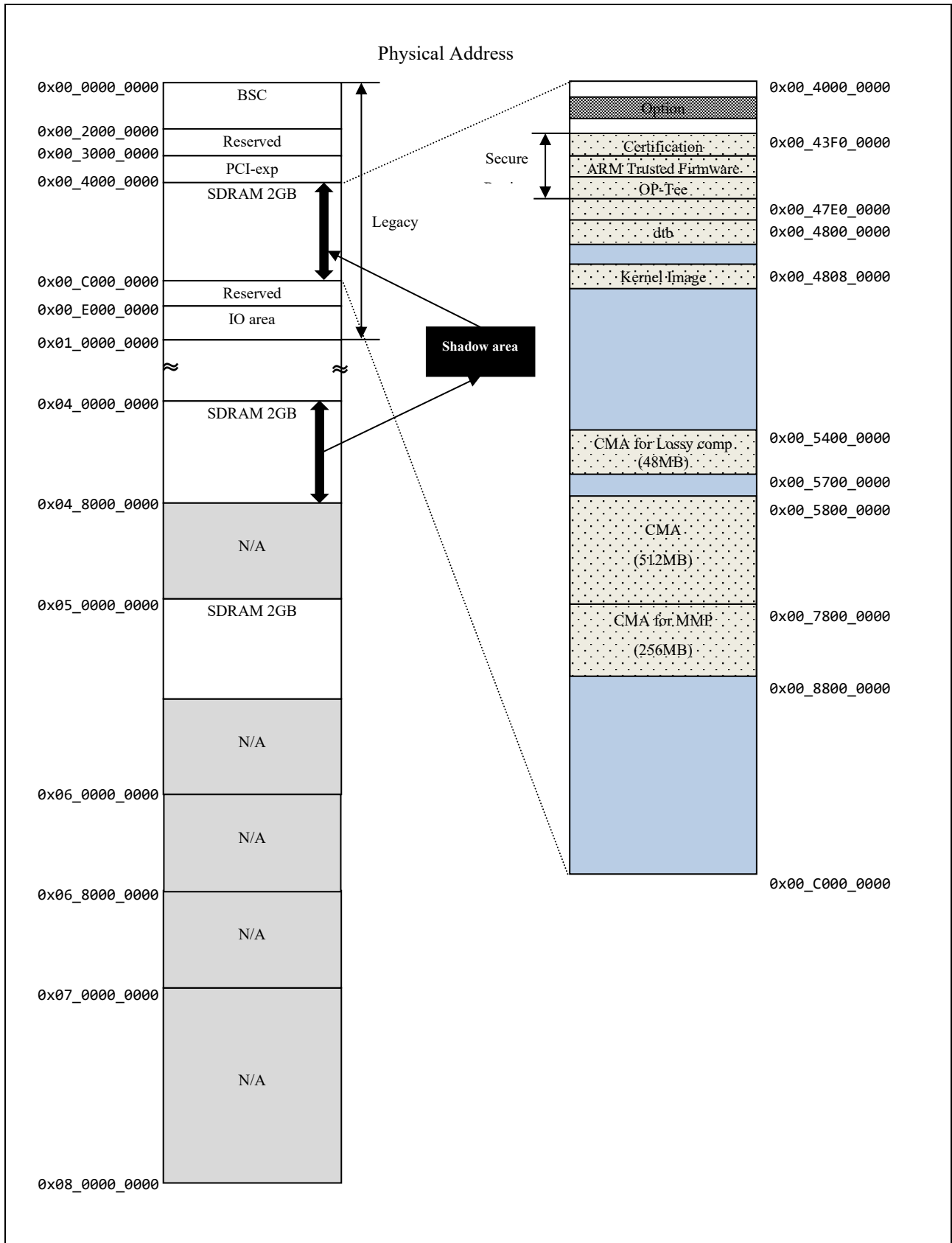

Figure 9. RZ/G2H System Evaluation Board (HiHope-RZG2H) memory map (Linux)

Note)

- Kernel region is assigned by Kernel device tree arch/arm64/boot/dts/renesas/xxx.dts and totally mapped to 1920MB (RZ/G2E System Evaluation Board EK874), 3968MB (RZ/G2M System Evaluation Board HiHope-RZG2M), 3968MB (RZ/G2N System Evaluation Board HiHope-RZG2N), 3968MB (RZ/G2H System Evaluation Board HiHope-RZG2H)

Kernel region consists of 1 part: (RZ/G2E System Evaluation Board EK874)

- 1920MB from 0x00\_4800\_0000 to 0x00\_BFFF\_FFFF

Kernel region consists of 2 part: (RZ/G2M System Evaluation Board HiHope-RZG2M)

- 1920MB from 0x00\_4800\_0000 to 0x00\_BFFF\_FFFF
- 2GB from 0x06\_0000\_0000 to 0x06\_7FFF\_FFFF

Kernel region consists of 2 part: (RZ/G2N System Evaluation Board HiHope-RZG2N)

- 1920MB from 0x00\_4800\_0000 to 0x00\_BFFF\_FFFF
- 2GB from 0x04\_8000\_0000 to 0x04\_EFFF\_FFFF

Kernel region consists of 2 part: (RZ/G2H System Evaluation Board HiHope-RZG2H)

- 1920MB from 0x00\_4800\_0000 to 0x00\_BFFF\_FFFF
- 2GB from 0x05\_0000\_0000 to 0x05\_7FFF\_FFFF

There are three types of CMA regions.

They are defined in device tree (arch/arm64/boot/dts/renesas/xxxx.dts).

- Default CMA region: It is for kernel, general drivers and multimedia package.

```
linux,cma {
    compatible = "shared-dma-pool";
    reusable;
    reg = <0x00000000 0xFFFFFFFF 0x0 0xYYYYYYYY>;
    linux,cma-default;
};
```

0xFFFFFFFF is start address of CMA region.

0xYYYYYYYY is size of CMA region.

Note)

- 128 MB in this CMA (RZ/G2M (v1.3, v3.0) |G2N|G2H 512MB, RZ/G2E 256MB) is reserved for kernel and general drivers, and the remaining RZ/G2M (v1.3, v3.0) |G2N|G2H 384 MB, RZ/G2E 128MB is reserved for multimedia package.
- The CMA region can be adjusted by changing the start address and the size.
- Should take care of the lack of memory allocated by kernel and general drivers when reducing the region size.

- CMA region for MMP: It is for multimedia package (specific H/Ws).

```
mmp_reserved: linux,multimedia {
    compatible = "shared-dma-pool";
    reusable;
    reg = <0x00000000 0xFFFFFFFF 0x0 0xFFFFFFFF>;
};
```

0xFFFFFFFF is start address of CMA region.  
0xFFFFFFFF is size of CMA region.

Note)

- Refer to User’s manual of Memory Manager in order to change CMA region for MMP.

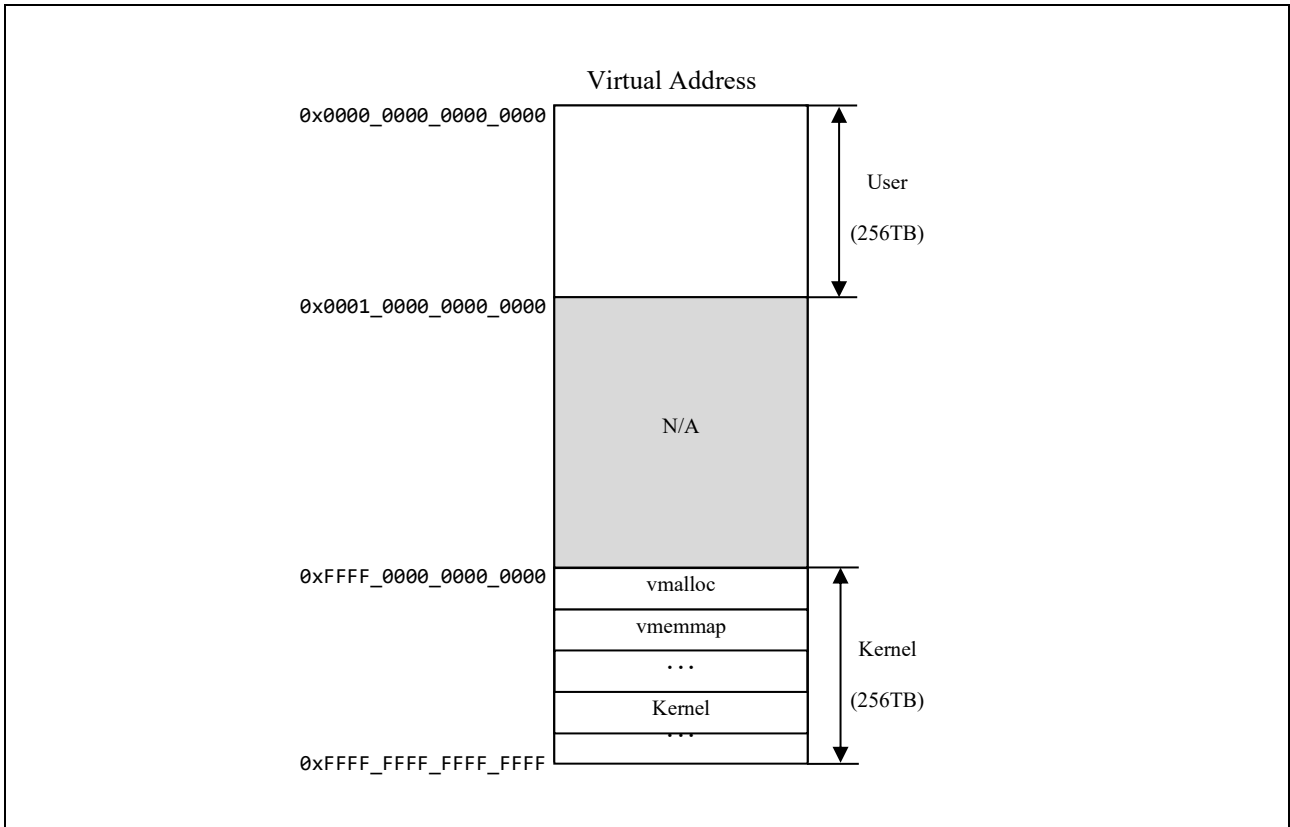

Figure 10. RZ/G2[H/M/N/E] memory map (Virtual)

Note)

- Kernel uses 4KB page size (VA\_BITS=48) and 4 levels of translation tables. Both regions of User and Kernel are 256TB. Refer to Documentation/arm64/memory.txt.
- Detail information about kernel memory map in virtual address space, refer to User’s manual of Kernel.

### 5.2.3 RZ/G2L Series

Following from Figure 11 to Figure 13 show memory map of RZ/G2L Series in this Linux BSP package.

Note)

- The volume of SDRAM is total:
  - 2GB (RZ/G2L Evaluation Board Kit PMIC version)
  - 1GB (RZ/G2LC and RZ/G2UL Evaluation Board Kit).
- The following region is used as a secure region. It doesn't allow U-Boot and kernel to access those regions.
  - 128MB from 0x00\_4000\_0000 to 0x00\_47FF\_FFFF in SDRAM

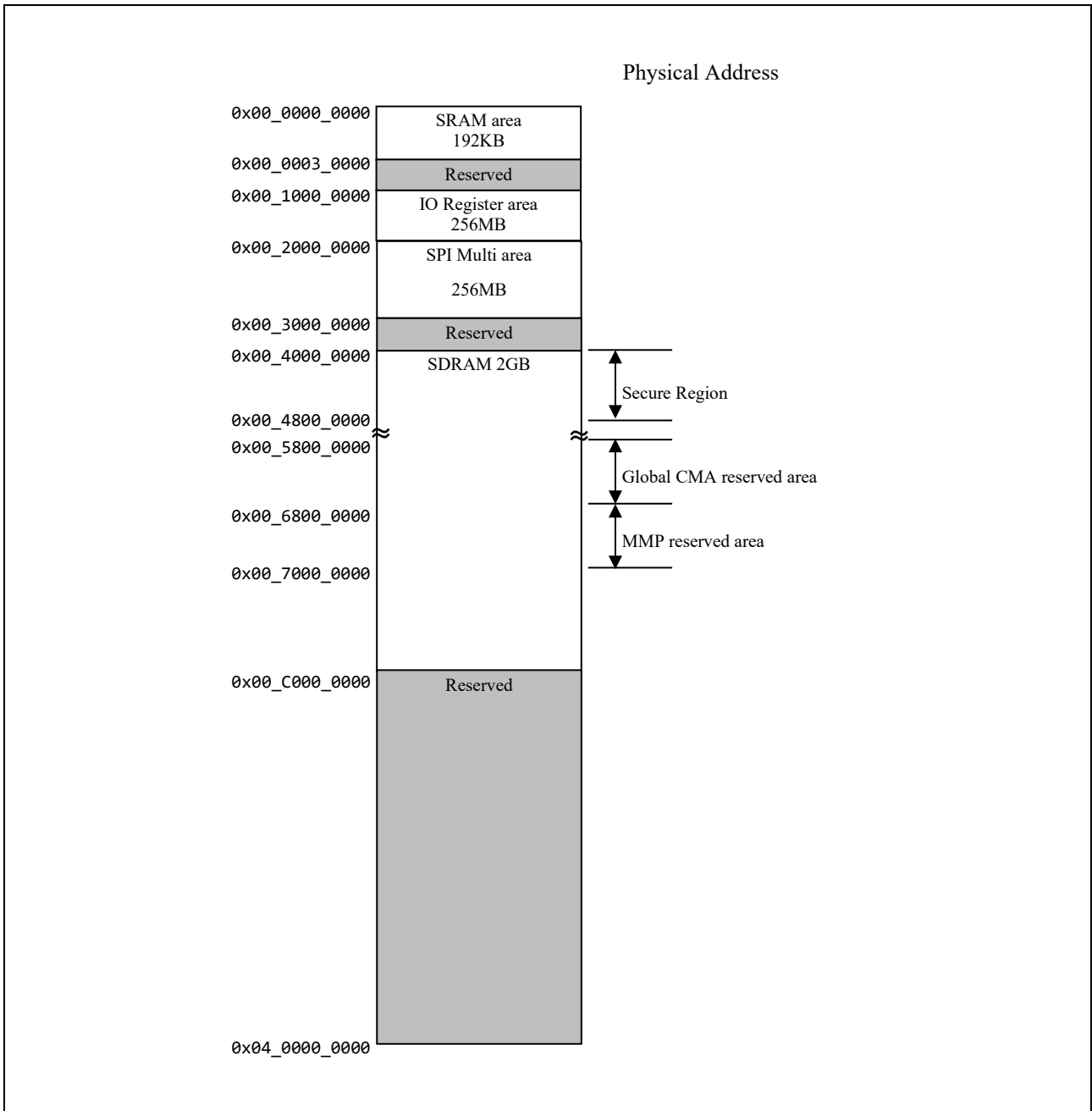

Figure 11. RZ/G2L Evaluation Board Kit PMIC version memory map (Boot)

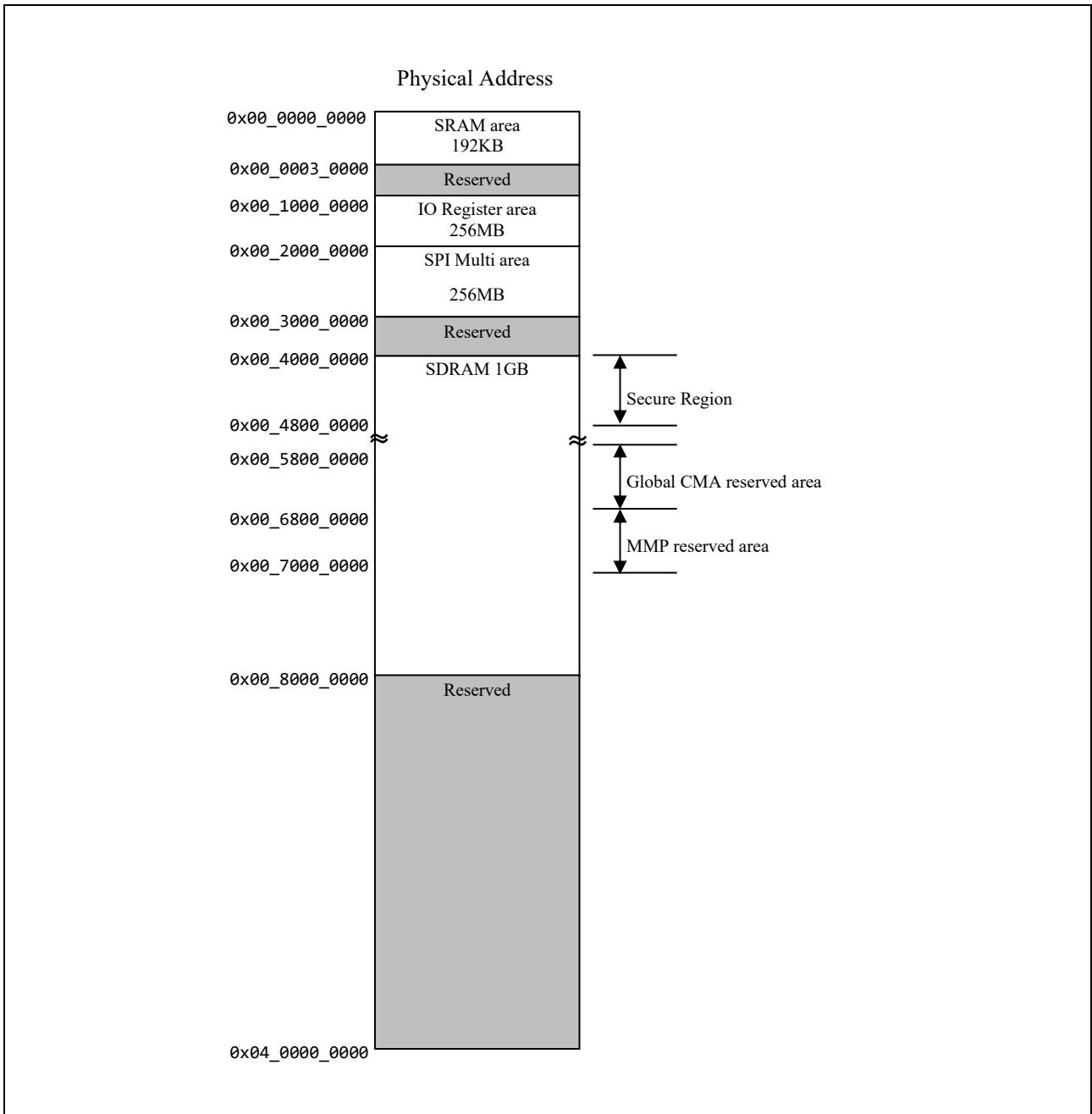

Figure 12. RZ/G2LC Evaluation Board Kit version memory map (Boot)

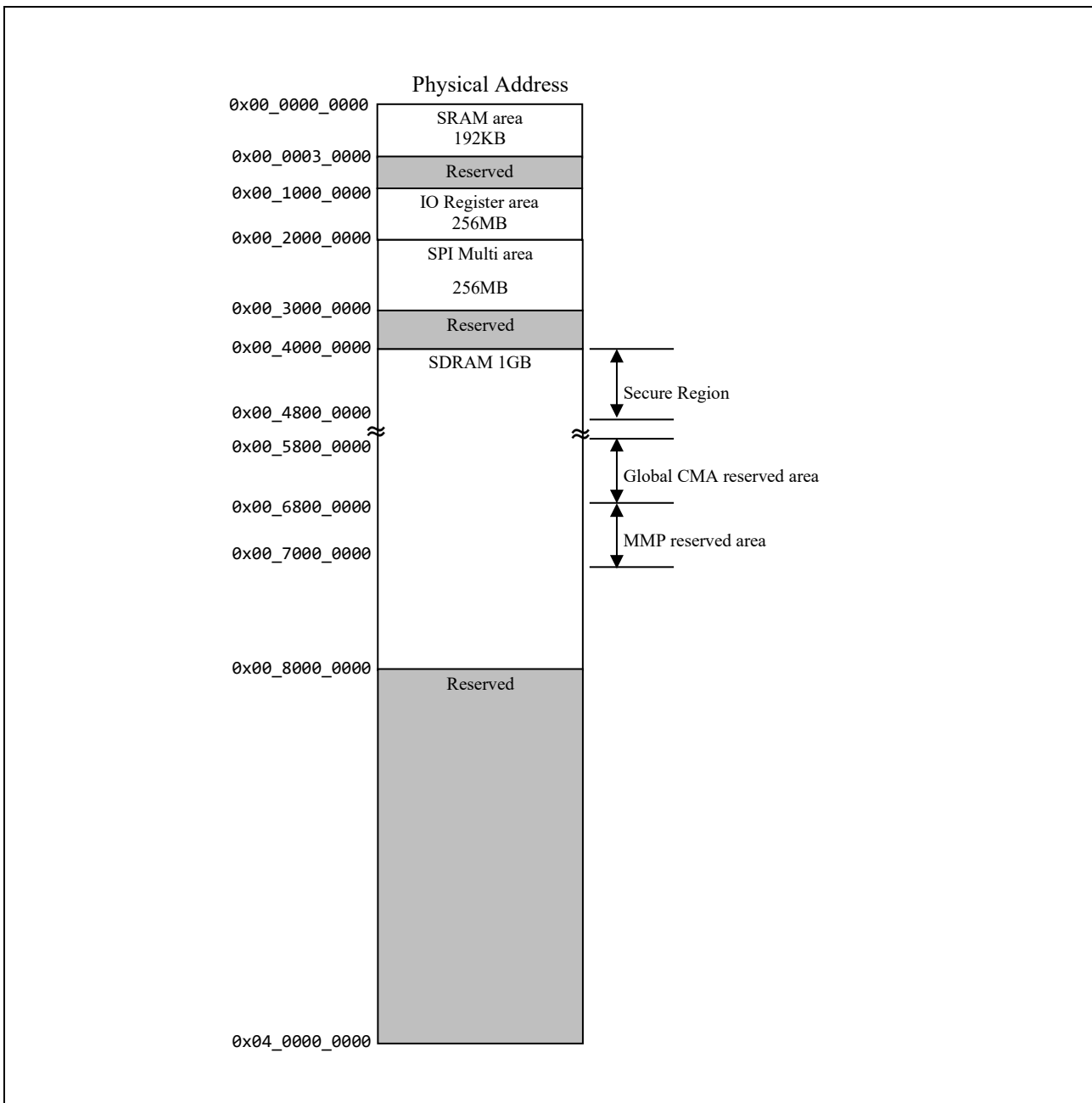

Figure 13. RZ/G2UL Evaluation Board Kit version memory map (Boot)



#### 5.2.4 RZ/G1H, RZ/G1M, RZ/G1N, RZ/G1E

Following Figure 16, Figure 17, Figure 18, Figure 18 shows memory map of this RZ/G1H, RZ/G1M, RZ/G1N, RZ/G1E Linux VLP package.

A saving area of the environment variable of U-Boot is address 0xc0000 of SPI Flash. If you would like to return default value, please use "env default -a" command, after that save by the saveenv command.

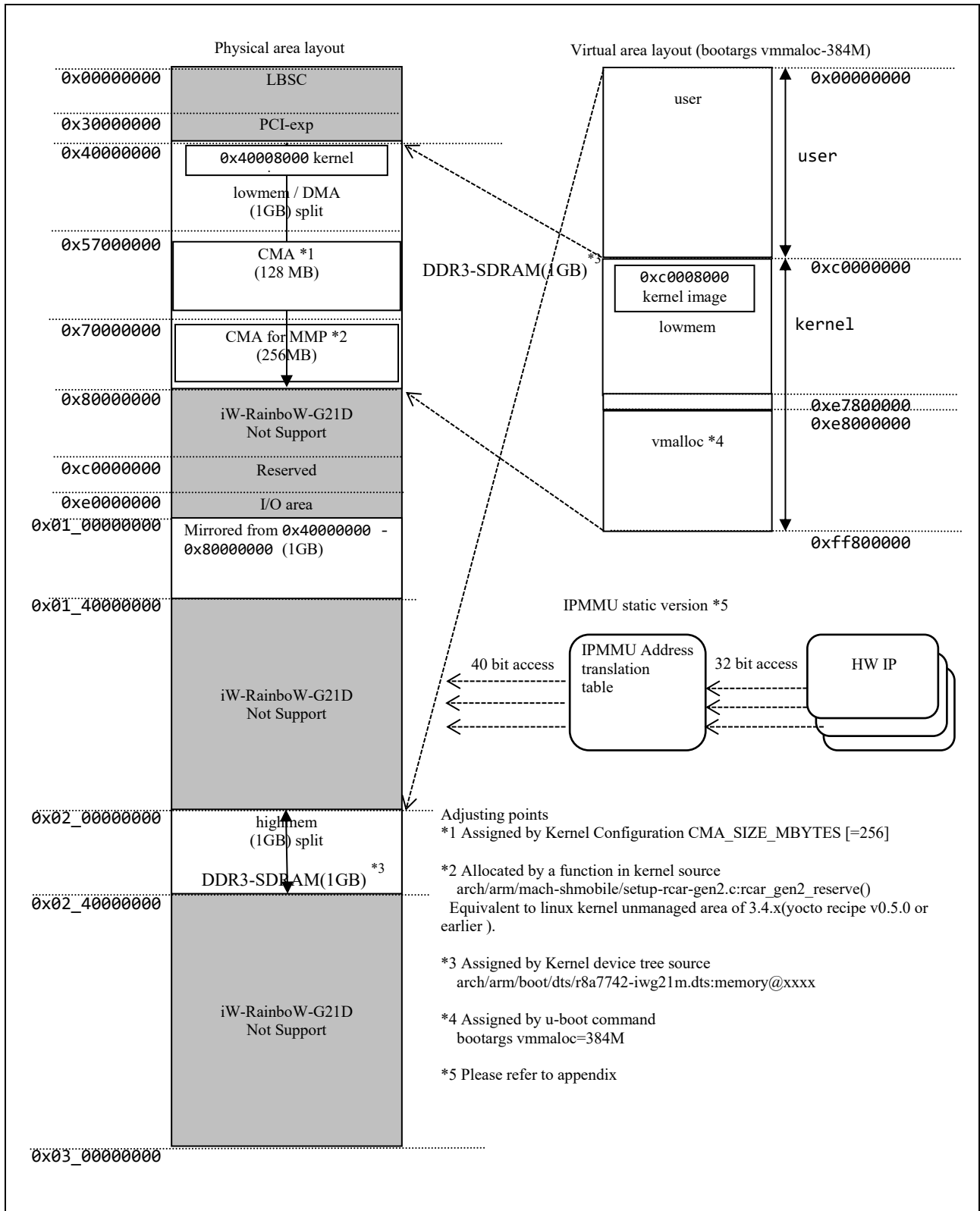

Figure 15. RZ/G1H memory map (Linux)

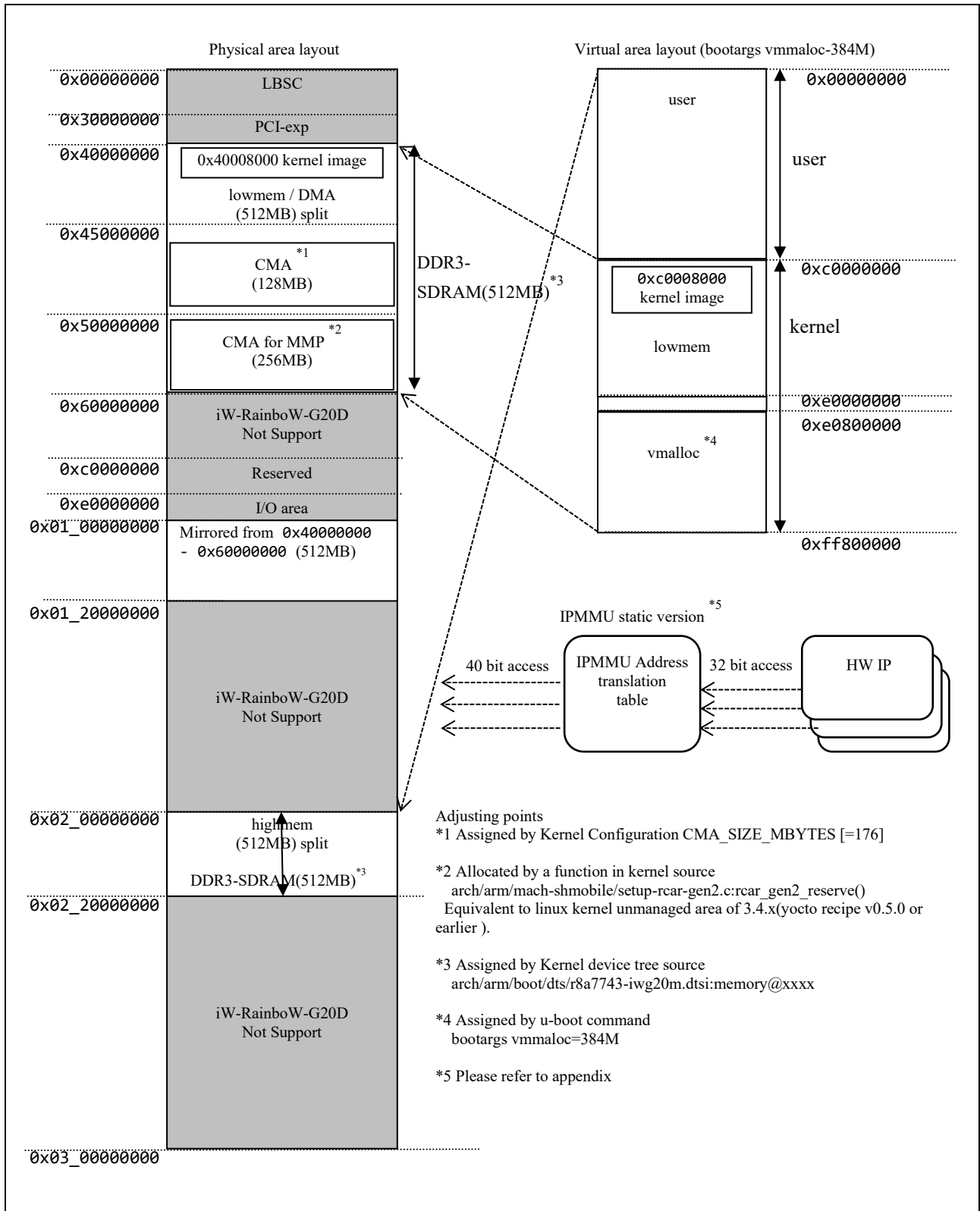

Figure 16. RZ/G1M memory map (Linux)

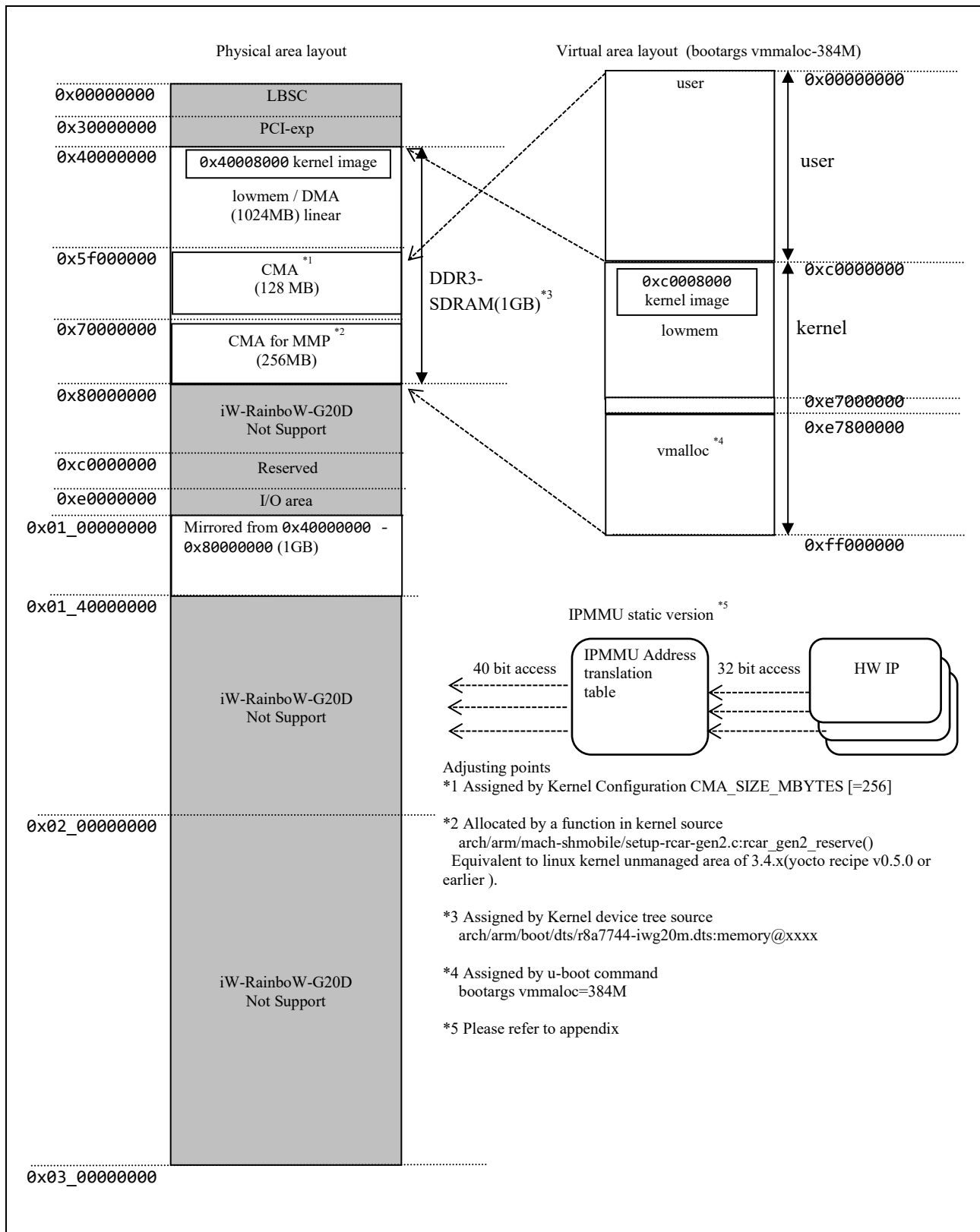

Figure 17. RZ/G1N memory map (Linux)

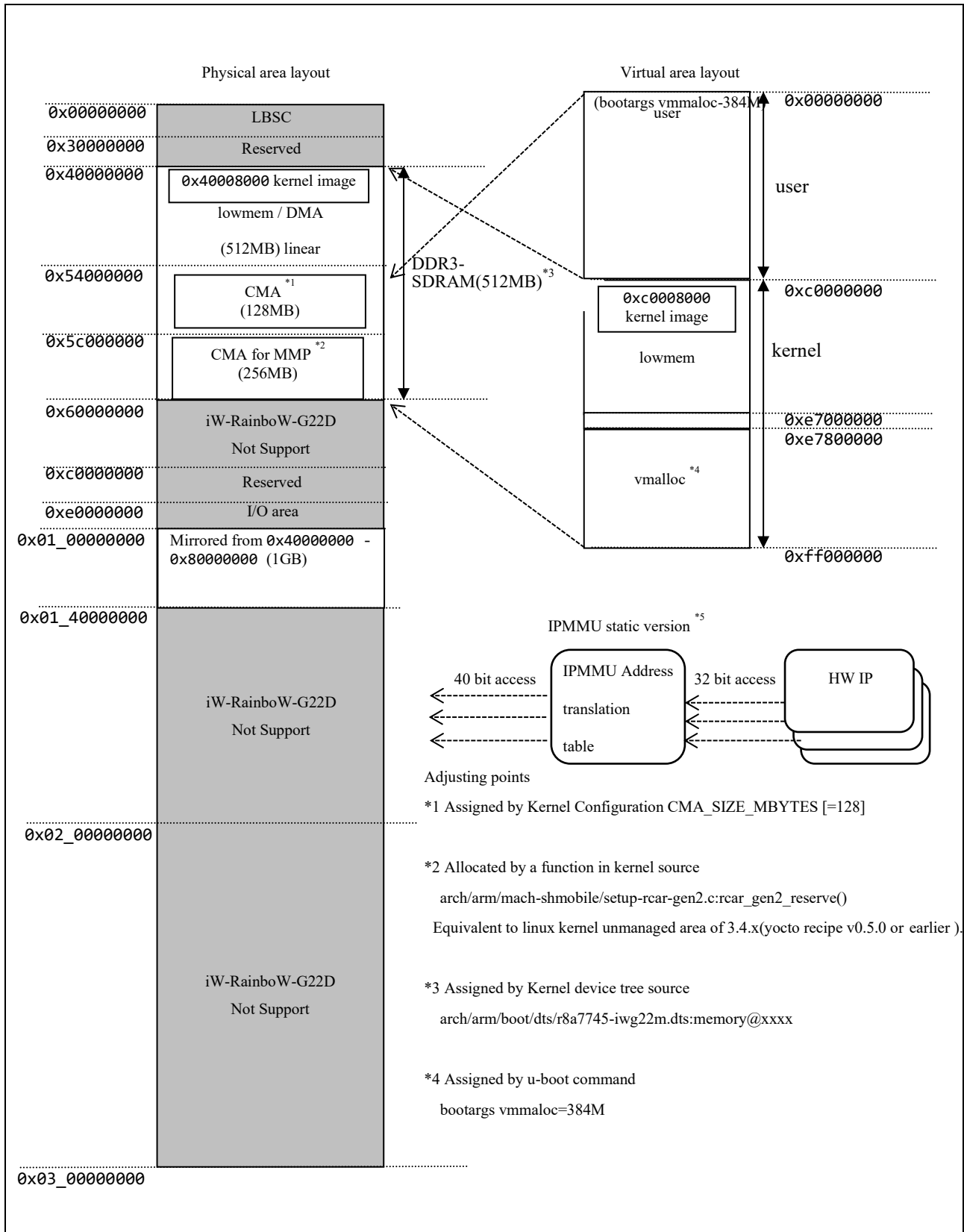

Figure 18. RZ/G1E memory map (Linux)

## 6. Revision History

Rev.	Date	Description	
		Page	Summary
1.01	Jul. 13, 2022	-	First edition for VLP/G v3.0.0-update1.
1.02	Jun. 24, 2022	11	Add the "Target devices" column to the Table 4.
		23	Fix the patch file name and the commands.
1.03	Jul. 8, 2022	5	Update the Graphics and Video codec libraries for RZ/G2L and RZ/G2L.
		15	Add the additional information to the table 7.
1.04	Aug. 9, 2022	-	Change some introduction about VLP/G v3.0.0-update1 to VLP/G v3.0.0-update 2.
		4	Update the Release Note and Component List. Add the additional information to OSS files.
		5	Update Optional packages.
		23	Add the update points of VLP/G v3.0.0-update2.
1.05	Sep. 30, 2022	-	First edition for VLP/G v3.0.1.
1.06	Mar. 30, 2023	-	First edition for VLP/G v3.0.3.
1.07	Apr. 21, 2023	4, 8	Update the Multimedia Package revision for RZ/G2H, RZ/G2M, RZ/G2N and RZ/G2E.
1.08	Oct. 31, 2023	-	First edition for VLP/G v3.0.5.
		-	Added support RZ/G1H, RZ/G1M, RZ/G1N, and RZ/G1E.
1.09	Nov. 15, 2023	-	Add the patch file of update1.
1.10	Nov. 30, 2023	3	Change "Linux_StartUp_Guide_RZG1H,M,N,E" revision.
1.11	Jan. 22, 2024	-	Add the patch file of update3.
1.12	Apr. 24, 2024	-	First edition for VLP/G v3.0.6.
		-	Added support RZ/G3S.
		8	Workaround when executing Docker command.
1.13	May 31, 2024	-	VLP/G v3.0.6-update1
		8	Delete 4 (5) Docker fir RZ/G2H and RZ/G2M section.
1.14	Jun. 14, 2024	-	VLP/G v3.0.6-update2
1.15	Jul. 31, 2024	-	VLP/G v3.0.6-update3
1.16	Mar. 31, 2025	-	VLP/G v3.0.7
1.17	Jul. 31, 2025	-	VLP/G v3.0.7-update2
1.18	Aug. 22, 2025	-	VLP/G v3.0.7-update3
1.19	Jan. 30, 2026	-	VLP/G v3.0.7-update4

## Website and Support

Renesas Electronics Website

<http://www.renesas.com/>

Inquiries

<http://www.renesas.com/contact/>

All trademarks and registered trademarks are the property of their respective owners.