

## Abstract

This technical brief explains the GIDEP Problem Advisory BP6-P-16-01 issued for the [ISL70001SEH](#), [ISL70001SRH](#) devices.

## Table of Contents

<b>Description of Problem</b> .....	<b>2</b>
<b>Summary of Simulation Results</b> .....	<b>2</b>
Discussion of Simulation Results .....	2
<b>Summary of Bench Testing Results Summary</b> .....	<b>12</b>
Discussion of Bench Testing Results.....	16
<b>ISL70001SEH, ISL70001SRH Implemented as Clock Slave or Externally Clocked Device</b> .....	<b>22</b>
<b>Summary</b> .....	<b>22</b>

## List of Figures

FIGURE 1. V <sub>OUT</sub> Response During a Power-Up .....	2
FIGURE 2. V <sub>OUT</sub> Power-Up/Down Anomalous Glitch Simulation Schematic .....	4
FIGURE 3. Power-Up Simulations of Nominal Processing at Three Temperatures .....	5
FIGURE 4. Power-Up Simulations of Process Corners 1 and 3 at +125°C.....	6
FIGURE 5. Power-Up Simulations of Process Corners 2 and 4 at +125°C.....	7
FIGURE 6. Simulations Close-Up View of Process Corners V <sub>OUT</sub> Glitch as Compared to 2x (V <sub>OUT</sub> = 2xVREF) the Soft-Start Voltage. ...	8
FIGURE 7. Process Corner 4 Ramp Down at +150°C.....	9
FIGURE 8. Pre and Post 100krad(Si) Power-Up Ramp for Nominal Process at +25°C .....	10
FIGURE 9. V <sub>OUT</sub> Simulation for Constant V <sub>IN</sub> = 1.796V to Produce a Steady-State Response .....	11
FIGURE 10. Power-Up Glitch for Unit LOT-3-1 at +25°C Prior to Irradiation .....	13
FIGURE 11. Power-Up Glitch for Unit LOT-3-1 at +25°C after Biased Irradiation to 100krad(Si) and 50-300rad(Si)/s .....	13
FIGURE 12. Power-Down Glitch for Unit LOT-1-2684 at +25°C .....	14
FIGURE 13. Power-Down Glitch for Unit LOT-3-1 at +25°C after Biased Irradiation to 100krad(Si) and 50-300rad(Si)/s .....	14
FIGURE 14. DC Behavior of Unit LOT-3-1 at +25°C .....	15
FIGURE 15. Power-Up Glitch Magnitudes at +25°C Plotted by Product Lot Groupings .....	18
FIGURE 16. Power-Down Glitch Magnitudes at +25°C Plotted by Product Lot Groupings.....	18
FIGURE 17. Anomalous DC V <sub>OUT</sub> Magnitudes at +25°C Plotted by Product Lot Groupings .....	19
FIGURE 18. Power-Up Glitch Magnitudes at Temperatures +25°C, +85°C, and +125°C for Four Sampled Units .....	20
FIGURE 19. Power-Down Glitch Magnitudes at Temperatures +25°C, +85°C, and +125°C for Four Sampled Units.....	20
FIGURE 20. LOT-1-2684 Power-Down Glitch at +125°C.....	21
FIGURE 21. Pre- and Post-Radiation (100krad(Si)) +25°C Power-Up Glitch Magnitudes.....	21
FIGURE 22. Pre- and Post-Radiation (100krad(Si)) +25°C Power-Down Glitch Magnitudes .....	22
FIGURE 23. Slow PVIN Rise, Resulting in Early Master LX and SYNC Activity With No Clocked Slave LX Activity .....	22

## Description of Problem

The ISL70001SRH and ISL70001SEH can exhibit a  $V_{OUT}$  response during a power-up or power-down period when  $V_{IN}$  is between 1.3V and 1.8V. This range of  $V_{IN}$  is below the nominal  $V_{IN}$  POR threshold of approximately 2.65V for PORSEL set to ground and 4.1V for PORSEL set to  $V_{IN}$ . For  $V_{IN}$  ramps of faster than 10V/ms this anomalous output activity is not possible, however, for slower  $V_{IN}$  ramps there is the possibility of output activity. During power-up,  $V_{OUT}$  follows a normal soft-start behavior, which will not exceed the  $V_{OUT}$  set-point voltage. During power-down  $V_{IN}$  ramp the activity again will not exceed the set-point voltage. The size of the anomalous  $V_{OUT}$  response is inversely related to the ramp rate of  $V_{IN}$  as this sets how long the part is in the anomalous activity range. See [Figure 1](#) for an illustration of the issue. This problem has been fixed on the [ISL70001ASEH](#).

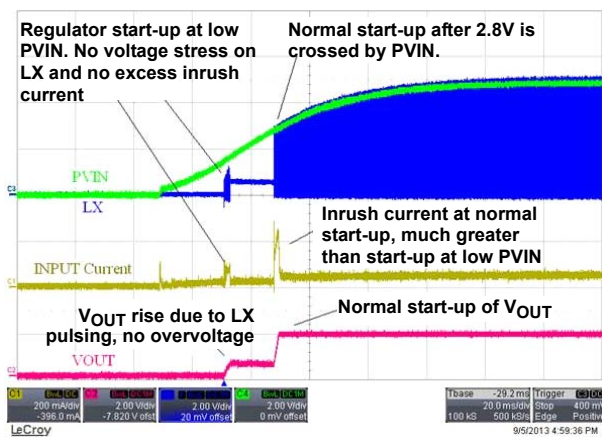

FIGURE 1.  $V_{OUT}$  RESPONSE DURING A POWER-UP

## Summary of Simulation Results

Transistor level simulations indicate that the ISL70001SEH, ISL70001SRH  $V_{OUT}$  glitch during power-up and power-down is limited by the soft-start voltage and ultimately by the selected  $V_{OUT}$  setting (e.g., 1.2V). The glitch is a normal soft-start event terminated when POR lockout becomes active by 1.8V. That is, the glitch will follow soft-start and not exceed the programmed output voltage setting, even if the  $V_{IN}$  stalls in the window of the anomalous switching activity. In the ramped power-up situation, the glitch is dominated by the soft-start voltage so the resulting glitch is substantially smaller than the selected output voltage. During power-down the soft-start voltage can cause the  $V_{OUT}$  to discharge if it is precharged to a non-zero value.

## Discussion of Simulation Results

Simulations were run for the anomalous  $V_{OUT}$  activity (glitch) during power-up and power-down for  $0V < V_{IN} < 2V$ . Simulations used the schematic shown in [Figure 2 on page 4](#). Note that the  $V_{IN}$  ramp rate was set to 0.2V/ms for both power-up and power-down. The results from the sequence of simulations run are summarized in [Table 1](#). The largest power-up glitch in a  $V_{OUT}$  of 426mV occurred for process corner 4 run at a temperature of +125 °C. This is well below the output set point of 1.2V. Slower ramps will lead to larger glitches, however, the set-point voltage

is never exceeded as indicated by the DC  $V_{IN}$  case at the bottom of [Table 1](#).

TABLE 1. SIMULATION RESULTS FOR POWER-UP/DOWN ANOMALOUS  $V_{OUT}$  GLITCH FOR  $V_{IN}$  RAMPING BETWEEN 0V AND 2V AT 0.2V/ms.

SIMULATION CONDITIONS	(Note 1)	VOUT GLITCH (V)
Power-up, Nominal Process, -55 °C	<a href="#">Figure 3</a>	0
Power-up, Nominal Process, +25 °C	<a href="#">Figure 3</a>	0.058
Power-up, Nominal Process, +125 °C (Worst temp)	<a href="#">Figure 3</a>	0.236
Power-up, Process Corner 1, +125 °C	<a href="#">Figure 4</a>	0.103
Power-up, Process Corner 3, +125 °C	<a href="#">Figure 4</a>	0
Power-up, Process Corner 2, +125 °C	<a href="#">Figure 5</a>	0.368
Power-up, Process Corner 4, +125 °C (Worst case)	<a href="#">Figure 5</a>	0.426
Power-down, Process Corner 4, +125 °C	<a href="#">Figure 7</a>	Discharges from 0.7V
Power-up, Post 100krad, Nominal process, +25 °C	<a href="#">Figure 8</a>	0.236
DC $V_{IN}$ = 1.796V for Process Corner 4, +125 °C	<a href="#">Figure 9</a>	1.178 for 1.200 set

NOTE:

- Simulation plots are in the called out Figures.

The first three simulations of [Table 1](#) are depicted in [Figure 3 on page 5](#). For the -55 °C case the oscillator (SynclO) never goes active so that the switching node (Phase1) never activates and consequently the output ( $V_{OUT}$ ) never charges. The fall of Dfeet activates the POR circuitry and blocks further switching until POR is released at about  $V_{IN}$  = 2.65V (for PORSEL set to ground). The +25 °C case shows both SynclO and Phase1 activity before Dfeet goes low. This short activity results in a  $V_{OUT}$  glitch of 58mV. At +125 °C the SynclO and Phase1 activity starts at a lower  $V_{IN}$  and proceeds to allow  $V_{OUT}$  to track the soft-start voltage (SS\_cap) with the selected feedback gain of 2x applied. In this case the  $V_{OUT}$  glitch reaches 236mV. The +125 °C case is the worst temperature for the glitch.

The four process corners were run at +125 °C and are the next four entries in [Table 1](#). The 1<sup>st</sup> and 3<sup>rd</sup> process corners are depicted in [Figure 4](#) in the same fashion as in [Figure 3](#). Corner 1 had a short episode of Phase1 activity that yielded an output glitch of 103mV. Corner 3 exhibited no Phase1 activity and consequently had no glitch on  $V_{OUT}$ . [Figure 5](#) depicts the results from the 2<sup>nd</sup> and 4<sup>th</sup> process corners. Both cases resulted in appreciable  $V_{OUT}$  glitches of 368mV and 426mV respectively. So the worst case power-up glitch of 426mV was seen for process corner 4 and a temperature of +125 °C.

[Figure 6 on page 8](#) shows the four process cases of power-up simulations at +125 °C comparing the  $V_{OUT}$  signal to 2x the soft-start voltage. The factor of 2 comes from the set-point voltage being set to 1.2V and the reference voltage being 0.6V. These plots highlight the fact that the soft-start voltage is in control of the glitch ramp. This indicates that the voltage control loop is functioning and in control of  $V_{OUT}$  and that a normal

soft-start has been initiated. This assertion is further supported by simulation results in [Figure 9 on page 11](#). This simulation allows the anomalous switching condition to continue by holding  $V_{IN} = 1.796V$ . The resulting  $V_{OUT}$  response ramps up to approximately the set-point voltage of 1.200V (1.178V) and then holds at that level. Again the voltage loop is seen to be active and in control of  $V_{OUT}$ .

A power-down ramp was simulated for process corner 4 at +150 °C and the results are presented in [Figure 7 on page 9](#). In this case the  $V_{OUT}$  was precharged to 0.7V to emulate the load discharging  $V_{OUT}$  to a diode drop indicative of an active load. The most interesting fact is that the anomalous switching activity leads to the  $V_{OUT}$  being discharged.

[Figure 8 on page 10](#) presents simulations to represent the effects of radiation. The pre-radiation case shown (on the left) is again the nominal process at +25 °C. The post-radiation (100krad(Si), on the right) is the process corner representing the nominal process post-radiation at +25 °C. The radiation has increased the glitch from 58mV to 236mV, but the form of the glitch in that it follows the soft-start voltage remains intact.

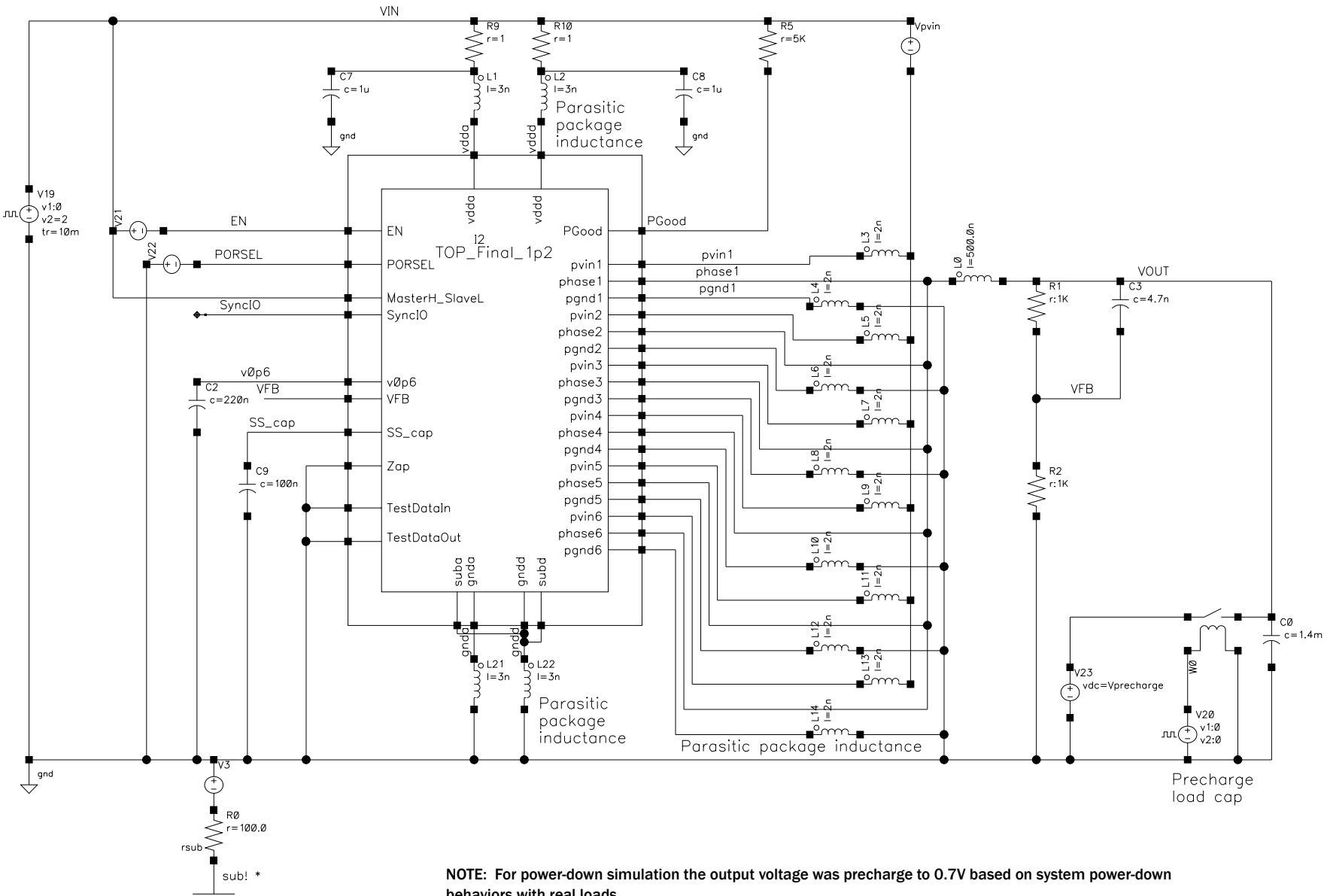

NOTE: For power-down simulation the output voltage was precharge to 0.7V based on system power-down behaviors with real loads.

FIGURE 2. V<sub>OUT</sub> POWER-UP/DOWN ANOMALOUS GLITCH SIMULATION SCHEMATIC

ISL70001 Power Up (VIN = 0.2V/ms, SS = 100nF, Cloud = 1400uF). ISL70001\_bill\_1p2 TOP\_PowerUp\_sim config\_singlechannel.  
 Tj = -55C

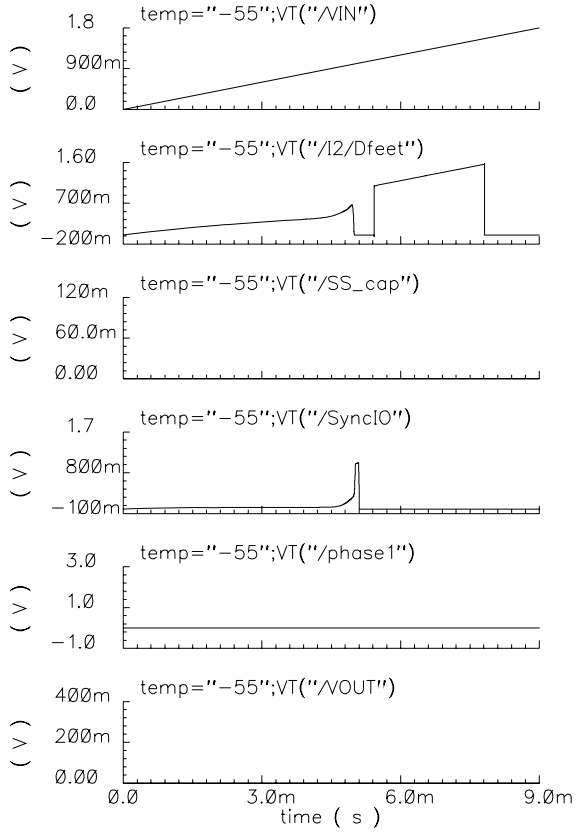

-55°C

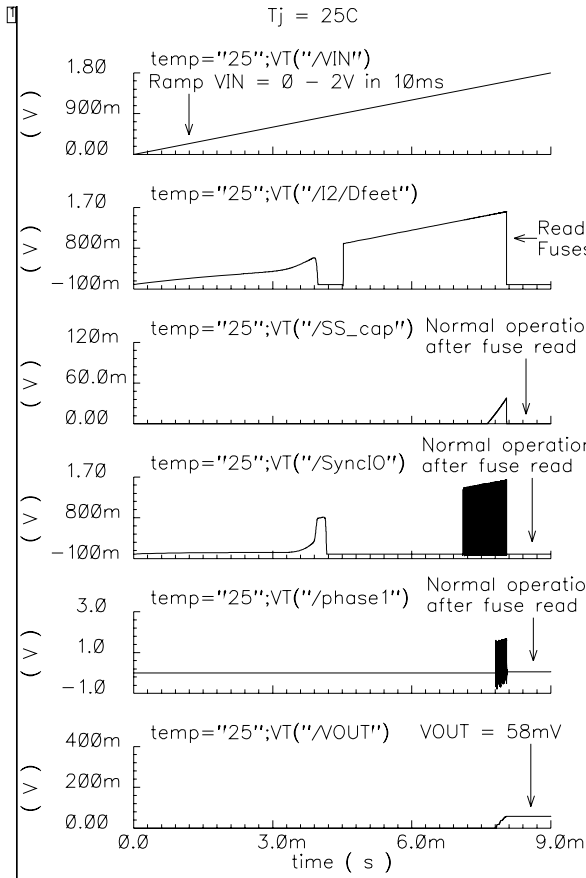

+25°C

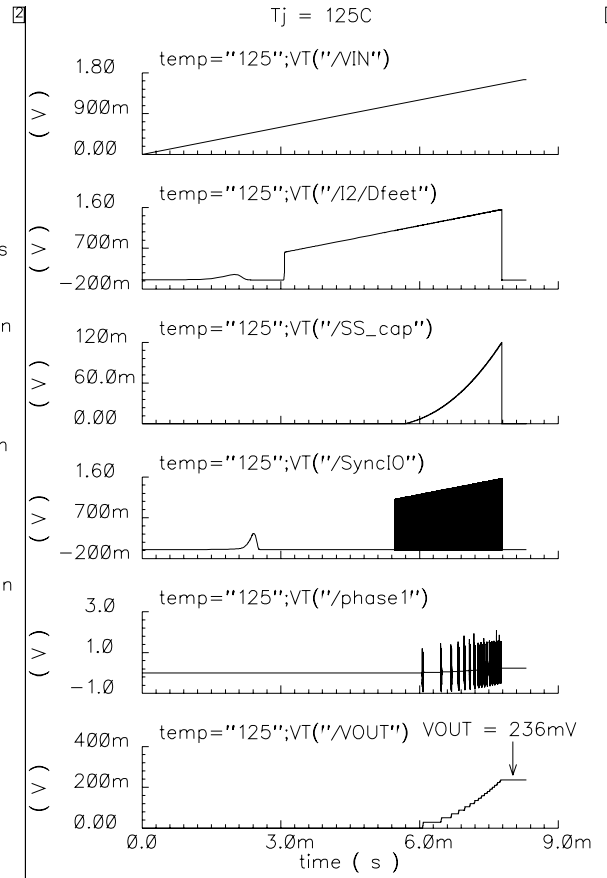

+125°C (PRODUCED WORST CASE VOUT GLITCH OF 236mV)

FIGURE 3. POWER-UP SIMULATIONS OF NOMINAL PROCESSING AT THREE TEMPERATURES

ISL70001 Power Up Process Corners (VIN = 0.2V/ms, SS = 100nF, Cloud = 1400uF, Tj = 125C). ISL70001\_bill\_1p2 TOP\_PowerUp\_sim config\_singlechannel.

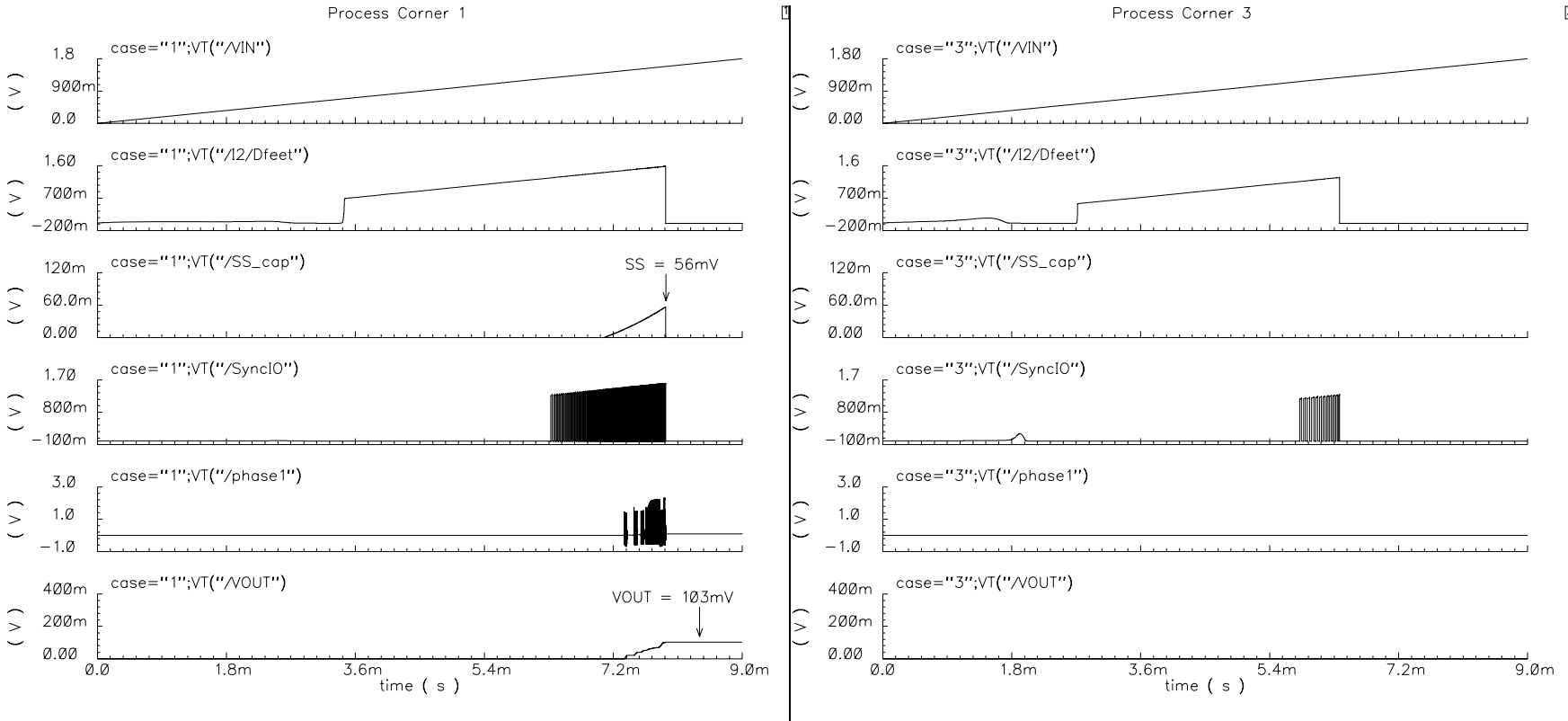

NOTE: Only corner 1 generated a V<sub>OUT</sub> glitch at 103mV.

FIGURE 4. POWER-UP SIMULATIONS OF PROCESS CORNERS 1 AND 3 AT +125 °C

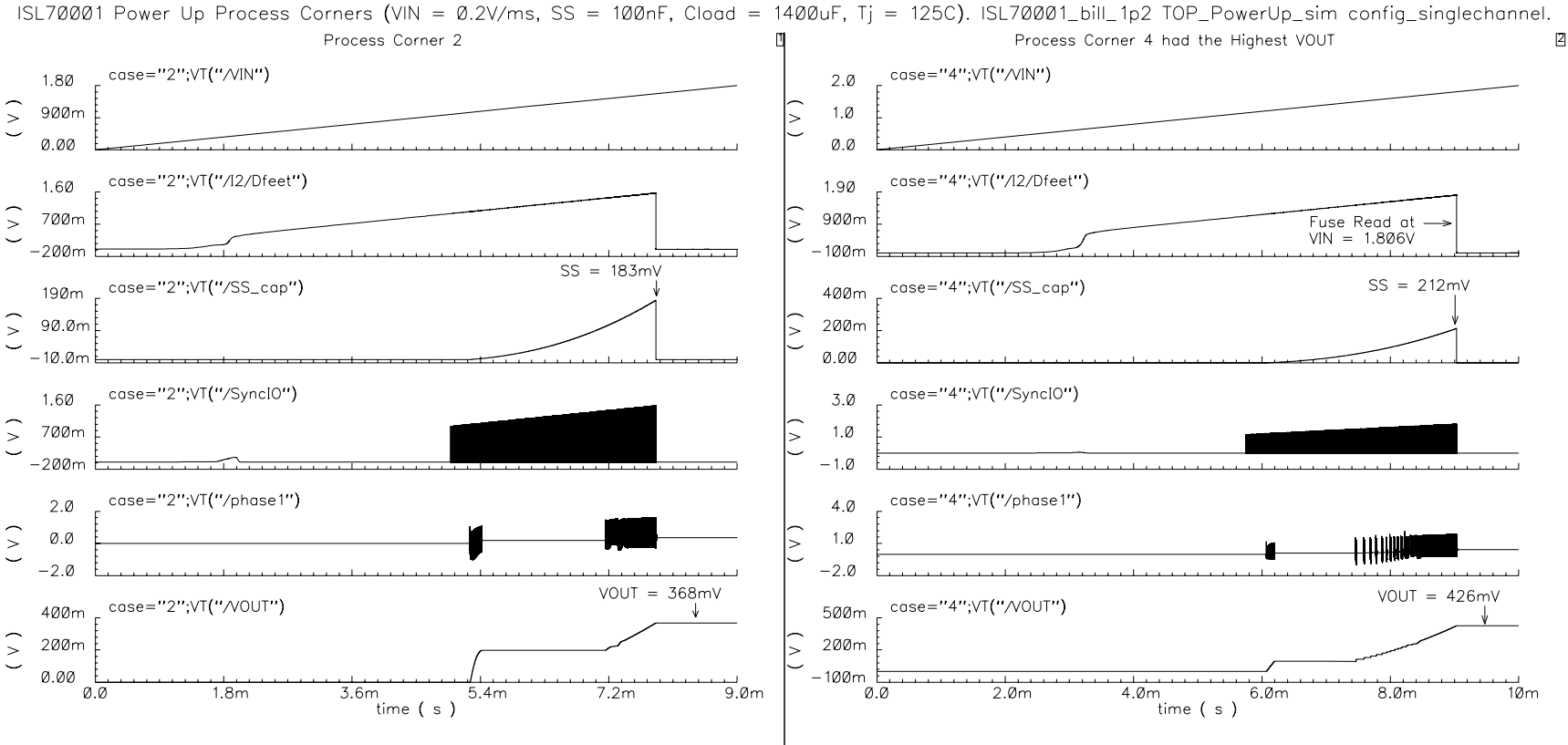
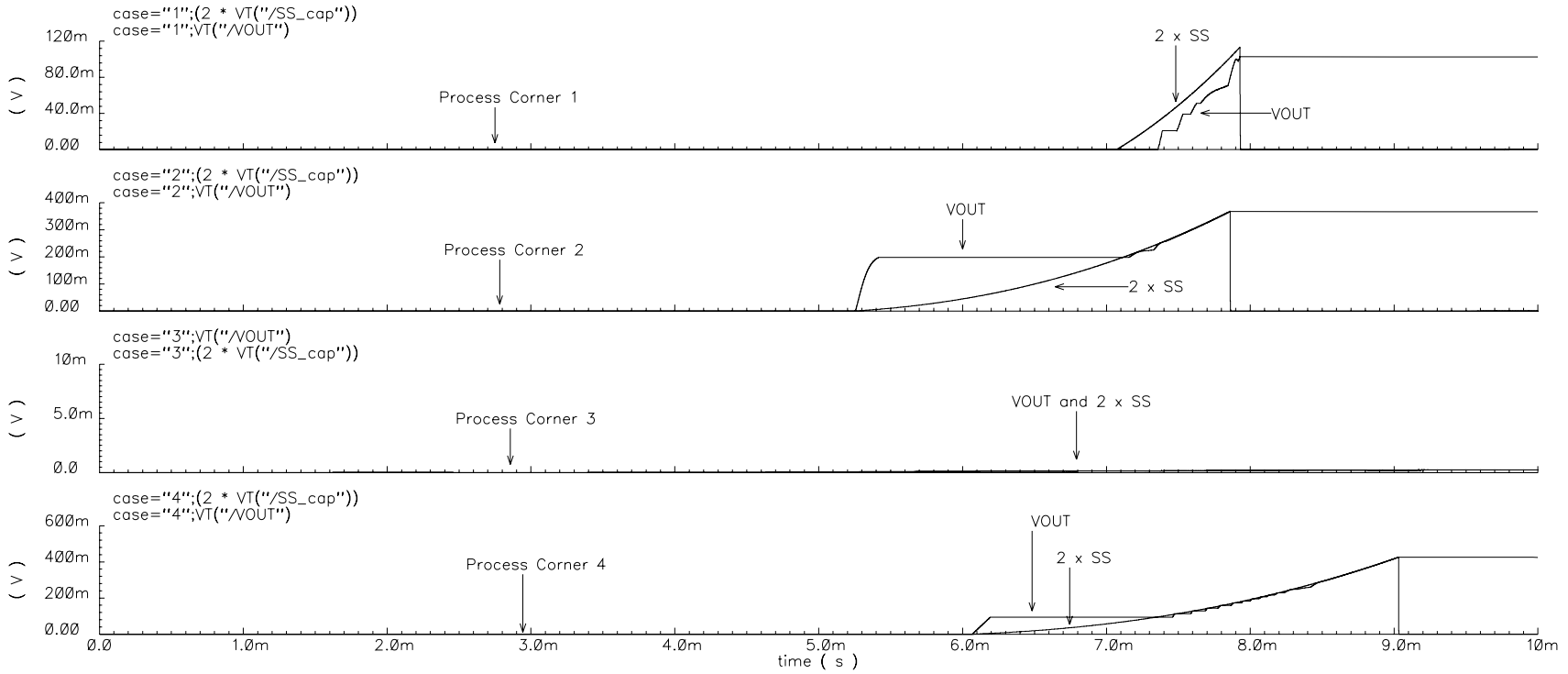

FIGURE 5. POWER-UP SIMULATIONS OF PROCESS CORNERS 2 AND 4 AT +125°C

ISL70001 Power Up Process Corners ( $V_{IN} = 0.2V/ms$ ,  $SS = 100nF$ ,  $C_{load} = 1400uF$ ,  $T_j = 125C$ ). ISL70001\_bill\_1p2 TOP\_PowerUp\_sim config\_singlechannel.



NOTE: These show that the glitch is limited by the soft-start voltage as the part follows a normal soft-start progression.

FIGURE 6. SIMULATIONS CLOSE-UP VIEW OF PROCESS CORNERS  $V_{OUT}$  GLITCH AS COMPARED TO  $2x (V_{OUT} = 2xV_{REF})$  THE SOFT-START VOLTAGE.

ISL70001 Power Down Process Corner 4 ( $V_{IN} = -0.2V/ms$ ,  $SS = 100nF$ ,  $C_{load} = 1400\mu F$ ,  $T_j = 150^{\circ}C$ ). ISL70001\_bill\_1p2 TOP\_PowerUp\_sim config\_singlechannel.  
 Transient Response

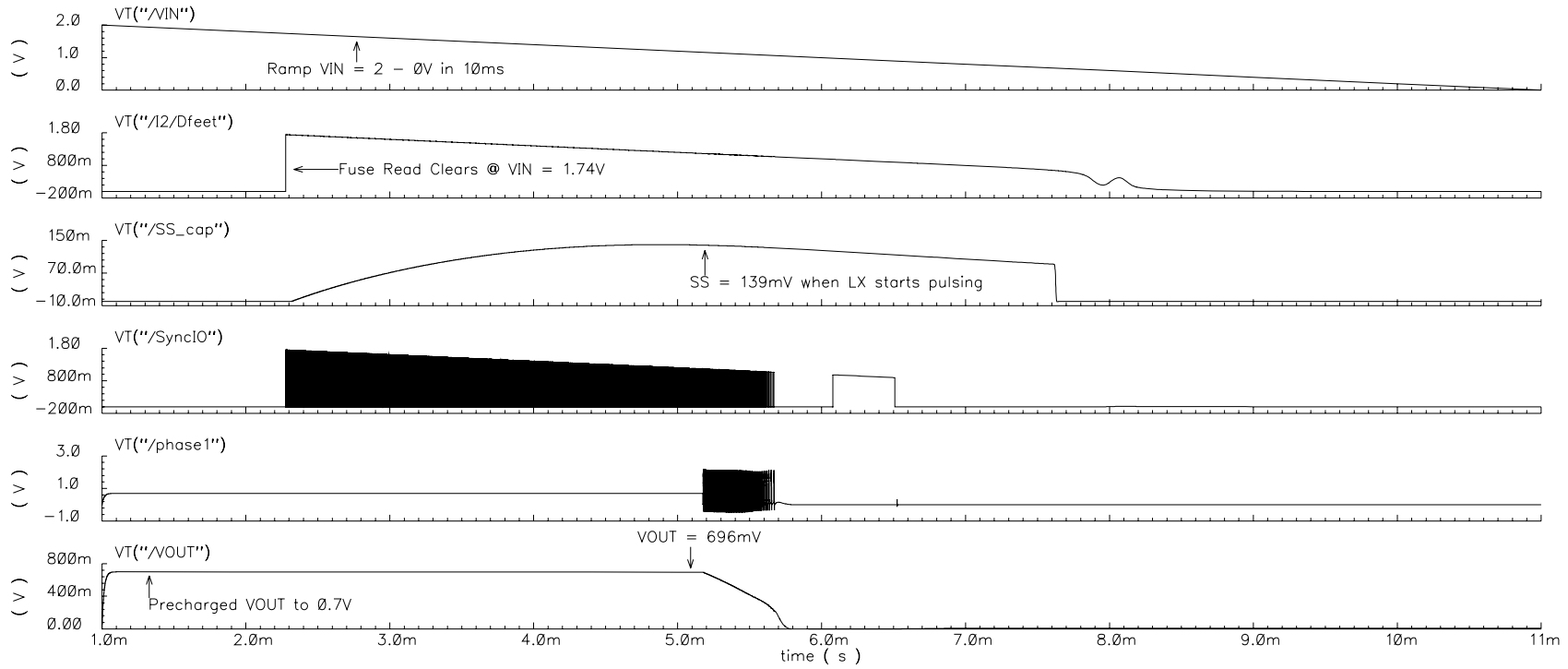

**NOTE:** Starting from a precharge of 0.7V to emulate power-down ramps of actual loads. The switching activity actually causes the  $V_{OUT}$  to discharge under soft-start voltage control.

**FIGURE 7. PROCESS CORNER 4 RAMP DOWN AT +150°C**

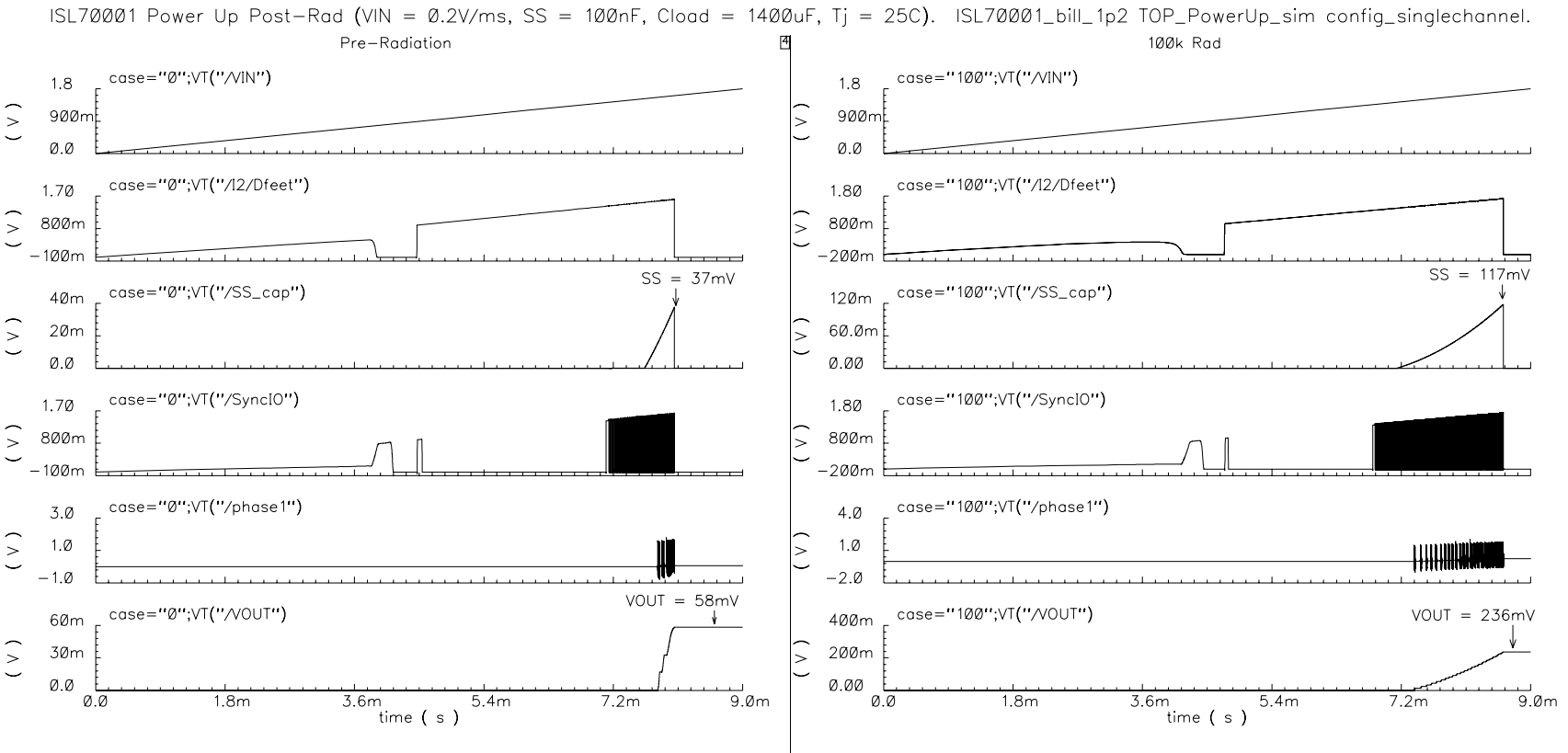
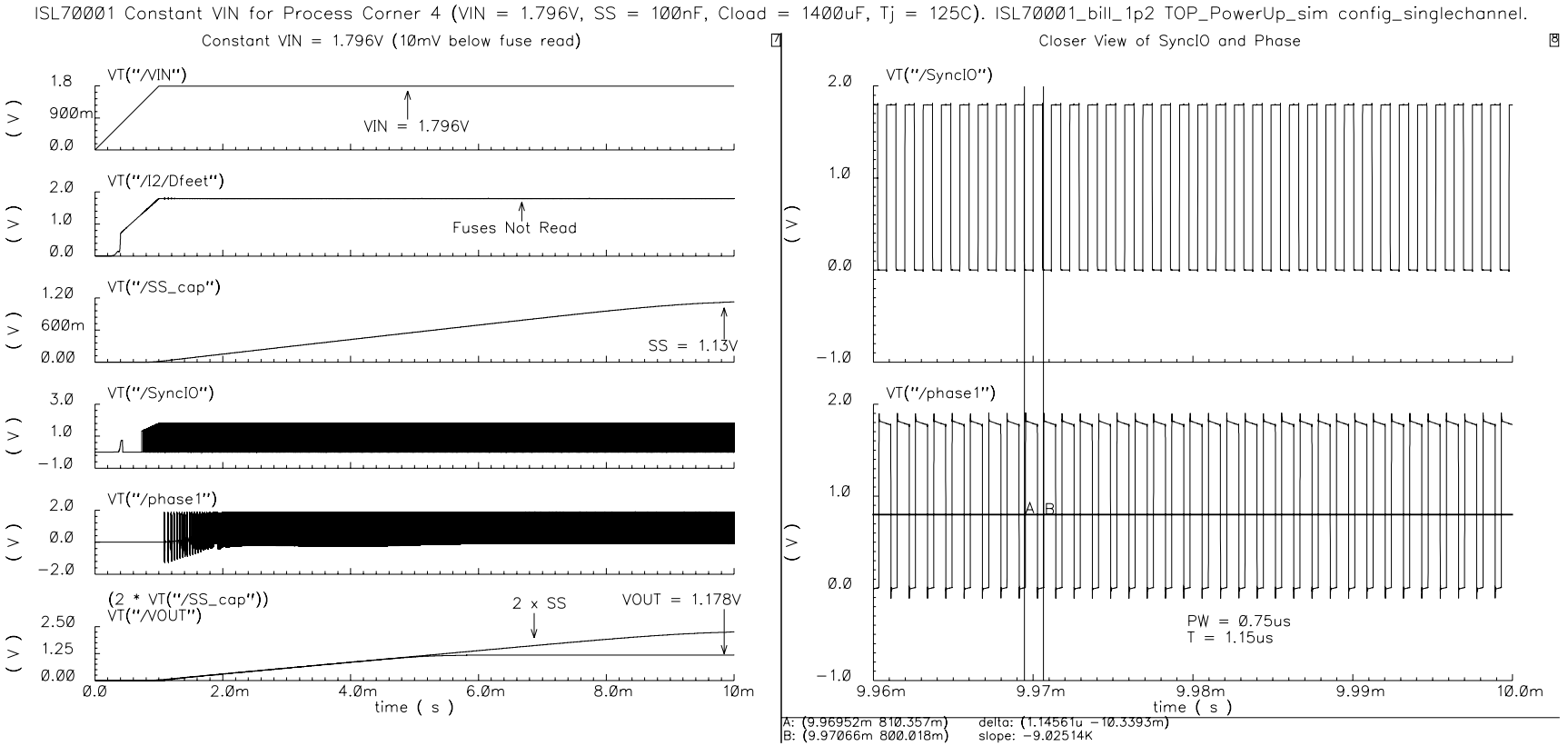

FIGURE 8. PRE AND POST 100krad(Si) POWER-UP RAMP FOR NOMINAL PROCESS AT +25 °C



**NOTE:** Conditions were process corner 4 and +125°C. V<sub>OUT</sub> stops rising at approximately the set-point voltage of 1.200V (1.178V untrimmed).

**FIGURE 9. V<sub>OUT</sub> SIMULATION FOR CONSTANT V<sub>IN</sub> = 1.796V TO PRODUCE A STEADY-STATE RESPONSE**

## Summary of Bench Testing Results Summary

Bench testing the ISL70001SEH, ISL70001SRH for the anomalous  $V_{OUT}$  response on power-up and power-down demonstrated that the glitch never exceeded 1V when the set voltage was 1.2V. This was true of all 40 units from five different production lots tested at +25°C as well as for the four units selected for testing at +125°C and the six units tested post irradiation to 100krad(Si) at 50-300rad(Si)/s. The pertinent parameters for the bench testing are listed in [Table 2](#).

**TABLE 2. PERTINENT PARAMETERS FOR BENCH TESTING ISL70001SEH, ISL70001SRH FOR POWER-UP AND POWER-DOWN ANOMALOUS  $V_{OUT}$  GLITCH.**

PARAMETER	VALUE
Input Capacitance	200 $\mu$ F
Output Inductor	1 $\mu$ H
Output Capacitance	500 $\mu$ F
Soft-Start Capacitance	100nF
VREF Capacitance	220nF
Output Set Voltage	1.2V
Power-Up Supply Ramp	Between 0.1 and 0.2V/ms
Power-Down Supply Ramp	Between -0.1 and -0.2V/ms
VIN Sweep Limits	0V to 2V

NOTE: Testing was done on a socketed ISL70001SEH, ISL70001SRH evaluation board.

The worst power-up glitch for all testing conditions was 627mV for irradiated LOT-3-1, which also registered the worst case +25°C power-up glitch at 296mV. The pre- and post-irradiation power-up glitches are presented in [Figures 10](#) and [11](#) respectively. It should be noted that both responses follow normal soft-start charging behavior until termination of the anomalous switching at about  $V_{IN} = 1.8V$ . In the post-irradiation case, [Figure 11](#), the  $V_{IN}$  ramp barely extended beyond the termination of the anomalous switching period leading to a result indicative of a much slower power-up ramp than intended. A faster ramp would have terminated the switching event sooner and led to a smaller glitch.

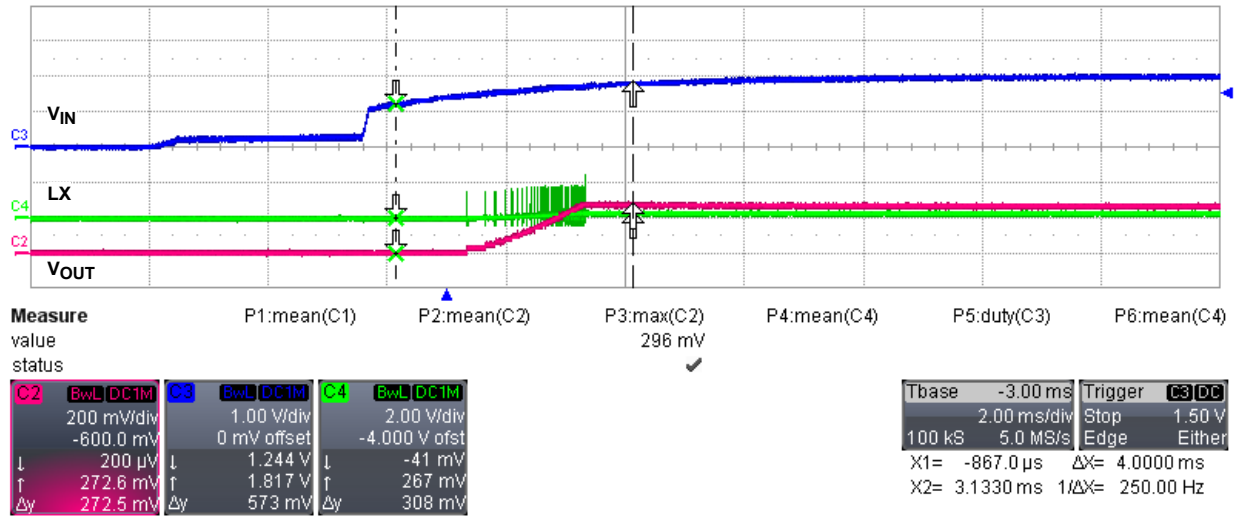

FIGURE 10. POWER-UP GLITCH FOR UNIT LOT-3-1 AT +25°C PRIOR TO IRRADIATION

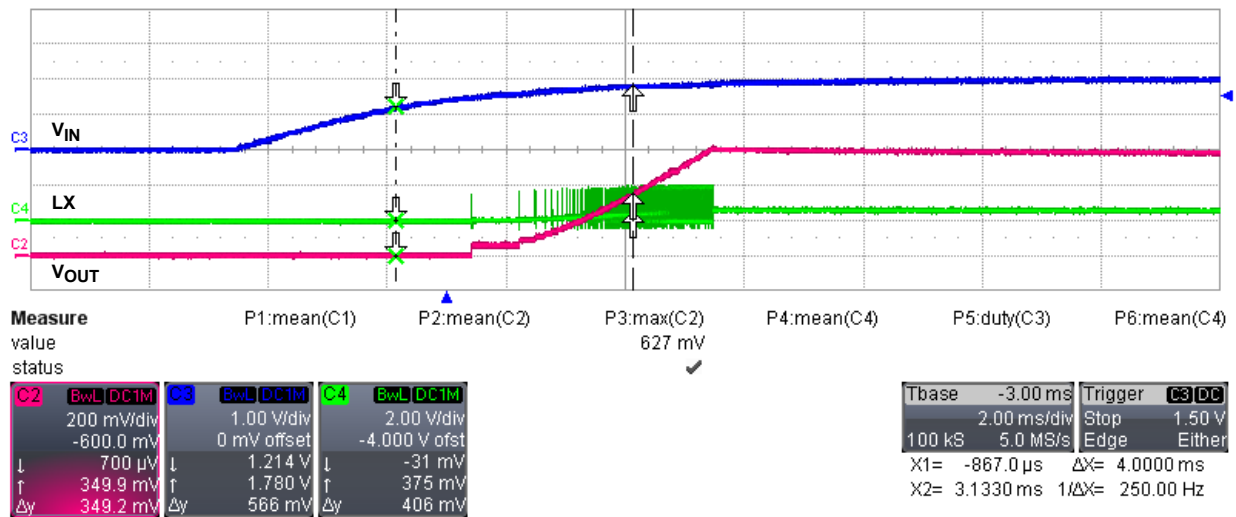

FIGURE 11. POWER-UP GLITCH FOR UNIT LOT-3-1 AT +25°C AFTER BIASED IRRADIATION TO 100krad(Si) AND 50-300rad(Si)/S

The worst case power-down glitch of 467mV was seen on unit LOT-1-2684 at +25°C and is represented in [Figure 12](#). The rapid V<sub>OUT</sub> charging at the end of switching activity was anomalous among the parts tested. The next worst power-down event was registered by unit LOT-3-1 after irradiation and is shown in

[Figure 13](#). The final discharge phase of the glitch was typical behavior.

Units were also tested for the DC condition of V<sub>IN</sub> held at the top of the region of anomalous switching. Of all the units tested in this fashion, LOT-3-1 exhibited the highest V<sub>OUT</sub> level at 905mV as is represented in [Figure 14 on page 15](#).

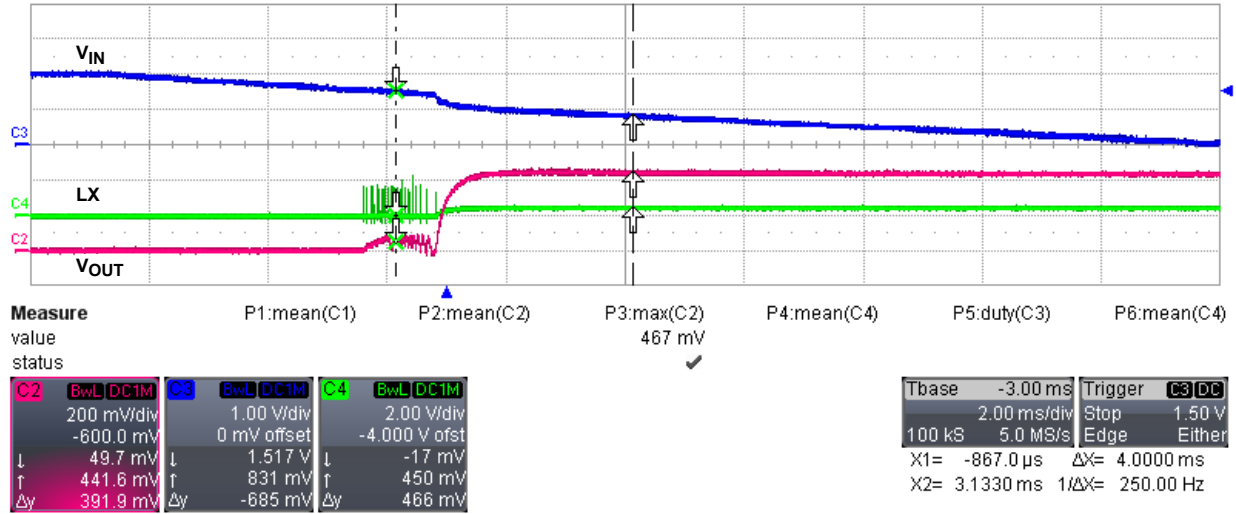

FIGURE 12. POWER-DOWN GLITCH FOR UNIT LOT-1-2684 AT +25°C

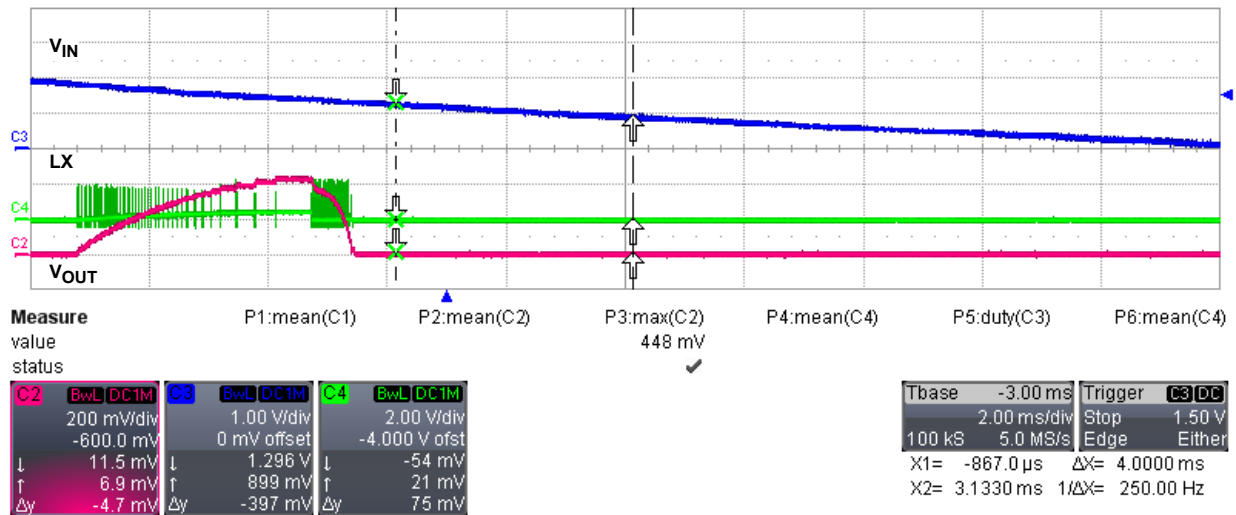

FIGURE 13. POWER-DOWN GLITCH FOR UNIT LOT-3-1 AT +25°C AFTER BIASED IRRADIATION TO 100krad(Si) AND 50-300rad(Si)/S

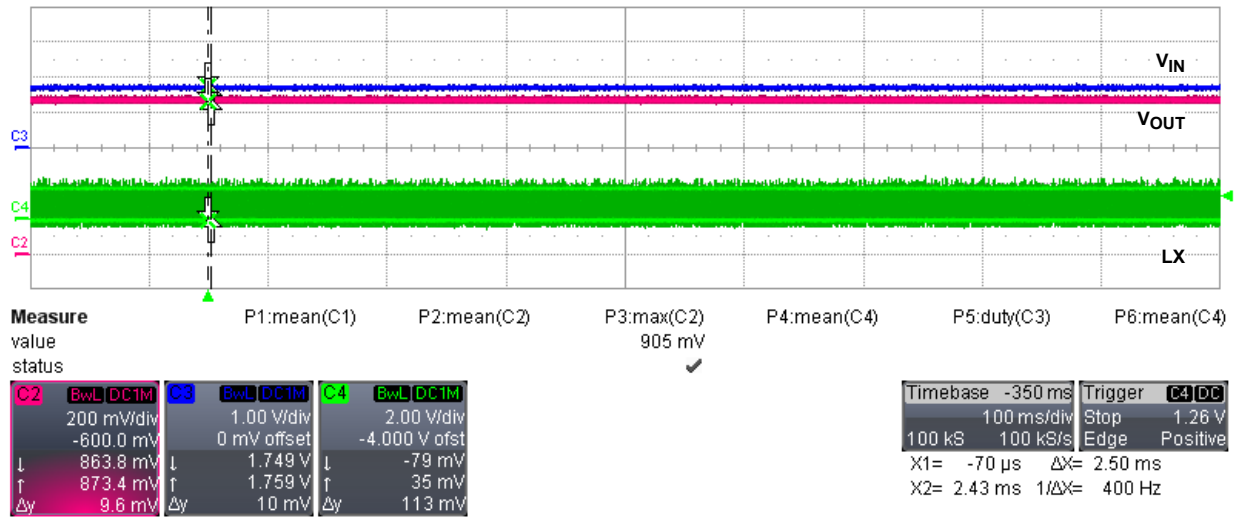

FIGURE 14. DC BEHAVIOR OF UNIT LOT-3-1 AT +25 °C

## Discussion of Bench Testing Results

Testing began with all 40 units tested at +25 °C for power-up, power-down, and DC anomalous  $V_{OUT}$ . Then four units were selected for testing at temperature (+85 °C and +125 °C), based on simulation results and bench testing indicating the worst case

condition to be high temperature. Finally six units were selected for biased irradiation and these parts were again tested at +25 °C. The tabular results of all this testing is presented in [Table 3](#).

**TABLE 3. RESULTS OF BENCH TESTING UNITS FOR ANOMALOUS  $V_{OUT}$  RESPONSES FOR  $V_{IN}$  RISING, FALLING AND DC OPERATION.**

LOT	SN	TEMP (°C)	krad(Si)	RISING (mV)	FALLING (mV)	DC (mV)
LOT-1	2621	+25	0	109	192	683
LOT-1	2625	+25	0	25	70	289
LOT-1	2626	+25	0	134	92	218
LOT-1	2634	+25	0	147	219	814
LOT-1	2660	+25	0	109	122	212
LOT-1	2661	+25	0	102	109	166
LOT-1	2662	+25	0	25	154	492
LOT-1	2664	+25	0	128	141	134
LOT-1	2665	+25	0	122	116	406
LOT-1	2666	+25	0	113	192	801
LOT-1	2667	+25	0	70	128	387
LOT-1	2668	+25	0	78	147	567
LOT-1	2669	+25	0	89	179	498
LOT-1	2670	+25	0	83	76	317
LOT-1	2684	+25	0	70	467	595
LOT-1	2684	+85	0	184	261	907
LOT-1	2684	+125	0	184	286	920
LOT-1	2688	+25	0	116	206	620
LOT-1	2691	+25	0	154	160	548
LOT-2	2859	+25	0	70	89	418
LOT-2	2860	+25	0	116	179	580
LOT-2	2862	+25	0	63		454
LOT-2	2864	+25	0	166	141	762
LOT-2	2865	+25	0	141	173	729
LOT-2	2866	+25	0	106	166	498
LOT-2	2868	+25	0	141	193	814
LOT-2	2874	+25	0	128	173	801
LOT-3	1	+25	0	296	297	905
LOT-3	1	+25	100	627	448	
LOT-3	2	+25	0	219	222	867
LOT-3	3	+25	0	212	265	867
LOT-3	3	+85	0	280	344	952
LOT-3	3	+125	0	280	389	1016
LOT-3	4	+25	0	212	232	873
LOT-3	4	+25	100	425	387	

TABLE 3. RESULTS OF BENCH TESTING UNITS FOR ANOMALOUS  $V_{OUT}$  RESPONSES FOR  $V_{IN}$  RISING, FALLING AND DC OPERATION. (Continued)

LOT	SN	TEMP (°C)	krad(SI)	RISING (mV)	FALLING (mV)	DC (mV)
LOT-3	5	+25	0	199	263	880
LOT-4	0	+25	0	219	303	867
LOT-4	0	+25	100	406	393	
LOT-4	1	+25	0	193	283	847
LOT-4	2	+25	0	238	296	873
LOT-4	2	+85	0	306	395	965
LOT-4	2	+125	0	325	408	978
LOT-4	7	+25	0	231	237	873
LOT-4	7	+25	100	436	399	
LOT-4	8	+25	0	219	375	867
LOT-5	5	+25	0	63	76	115
LOT-5	6	+25	0	26	86	179
LOT-5	7	+25	0	134	224	542
LOT-5	7	+85	0	235	325	920
LOT-5	7	+125	0	242	363	971
LOT-5	8	+25	0	128	147	215
LOT-5	8	+25	100	296	399	
LOT-5	9	+25	0	96	237	606
LOT-5	9	+25	100	406	356	

The power-up glitch results at +25 °C are graphically presented in [Figure 15 on page 18](#). The extreme point correlates to unit LOT-3-1 and is represented in [Figure 10 on page 13](#).

The power-down glitches at +25 °C are graphically represented in [Figure 16 on page 18](#). The extreme value of 467mV corresponds to LOT-1-2684 and is represented in [Figure 12 on page 14](#). This case is an outlier in its form and magnitude. All other parts exhibited a discharge to zero as is the case in [Figure 13 on page 14](#).

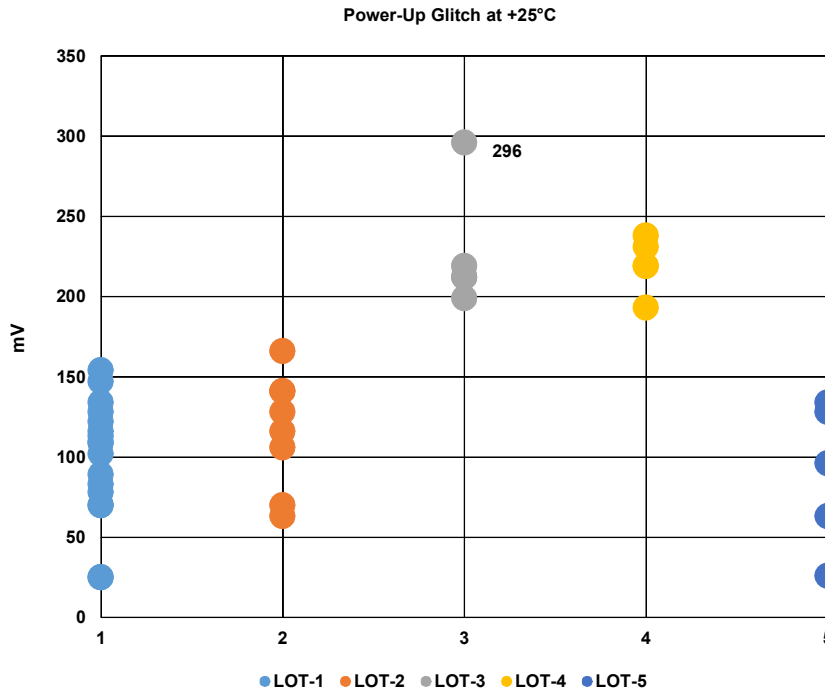

FIGURE 15. POWER-UP GLITCH MAGNITUDES AT +25 °C PLOTTED BY PRODUCT LOT GROUPINGS

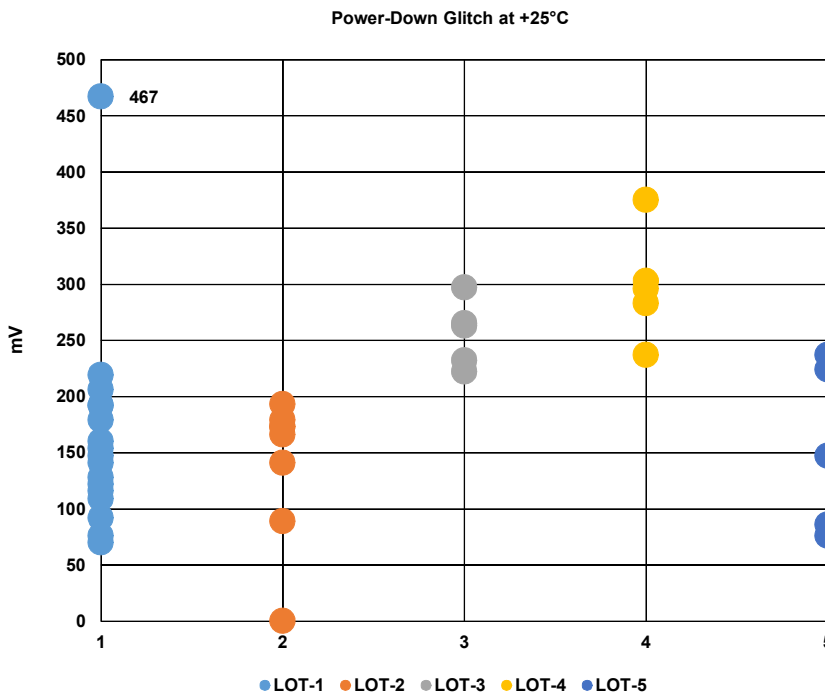

FIGURE 16. POWER-DOWN GLITCH MAGNITUDES AT +25 °C PLOTTED BY PRODUCT LOT GROUPINGS

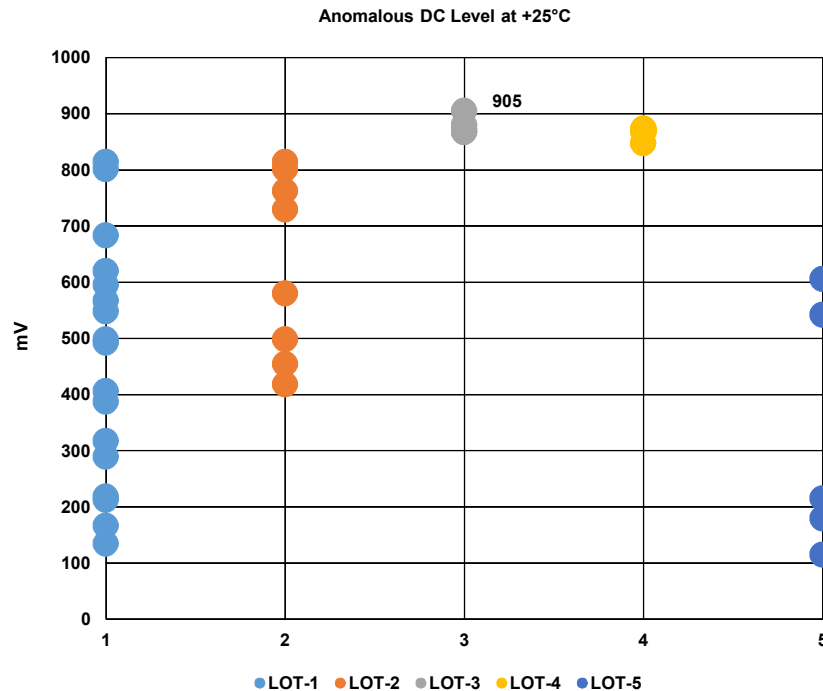

FIGURE 17. ANOMALOUS DC  $V_{OUT}$  MAGNITUDES AT +25°C PLOTTED BY PRODUCT LOT GROUPINGS

The parts were also operated with  $V_{IN}$  being a DC level and adjusted to give the maximum  $V_{OUT}$  output. The results are graphically represented in [Figure 17](#). All parts tested exhibited output voltages less than the set-point at 1.2V.

Four units were selected to test at elevated temperature. As represented in [Figure 18 on page 20](#) all four units tended toward larger power-up glitches as temperature increased. The maximum delta from +25°C was only 114mV at +125°C and the resulting maximum glitch at +125°C was only 325mV. The power-down glitch magnitudes are shown in [Figure 19 on page 20](#). Unit LOT-1-2684 showed more typical behavior at the elevated temperatures than it did at +25°C. The +125°C behavior is depicted in [Figure 20 on page 21](#). This behavior lacks the abrupt rise in  $V_{OUT}$  seen in [Figure 12 on page 14](#) and is responsible for the reduced glitch magnitude.

Another six units were selected for post radiation testing. The units were irradiated in the standard biased configuration at 50-300rad(Si)/s to a dose of 100krad(Si). Then, the parts were again tested for glitches at +25°C. [Figure 21 on page 21](#) shows the pre- and post-irradiation power-up glitch magnitudes measured at +25°C. The irradiation led to larger glitch magnitudes with the largest one being LOT-3-1 as already shown in [Figure 11 on page 13](#). The power-down glitch behavior over radiation is shown in [Figure 22 on page 22](#). Again the extreme case is that of LOT-3-1 and has already been shown in [Figure 11 on page 13](#).

Nothing in all the testing done implies that the power-up or power-down behavior of the part will result in the  $V_{OUT}$  exceeding the set point (1.2V in the bench cases here). This is consistent with the simulation results.

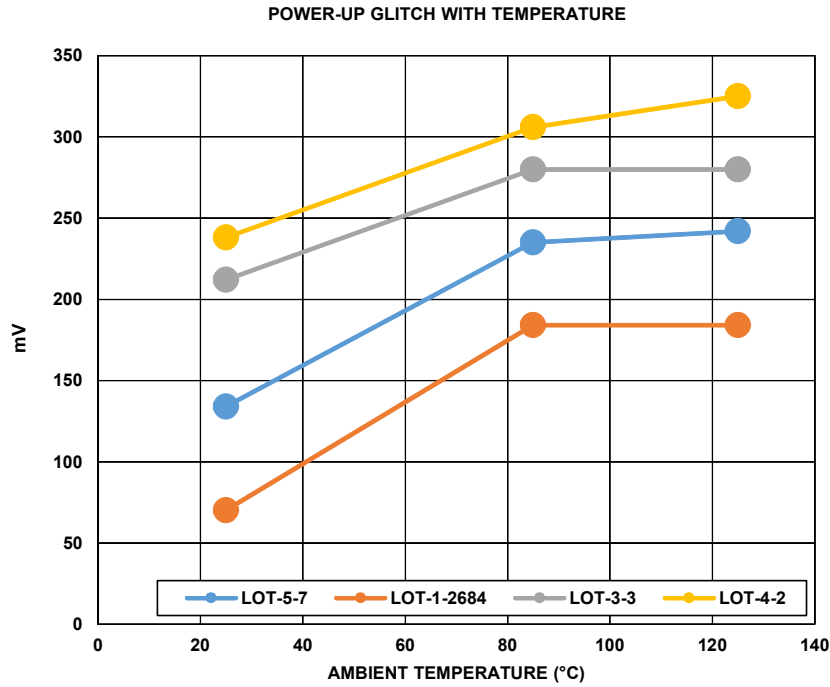

FIGURE 18. POWER-UP GLITCH MAGNITUDES AT TEMPERATURES +25°C, +85°C, AND +125°C FOR FOUR SAMPLED UNITS

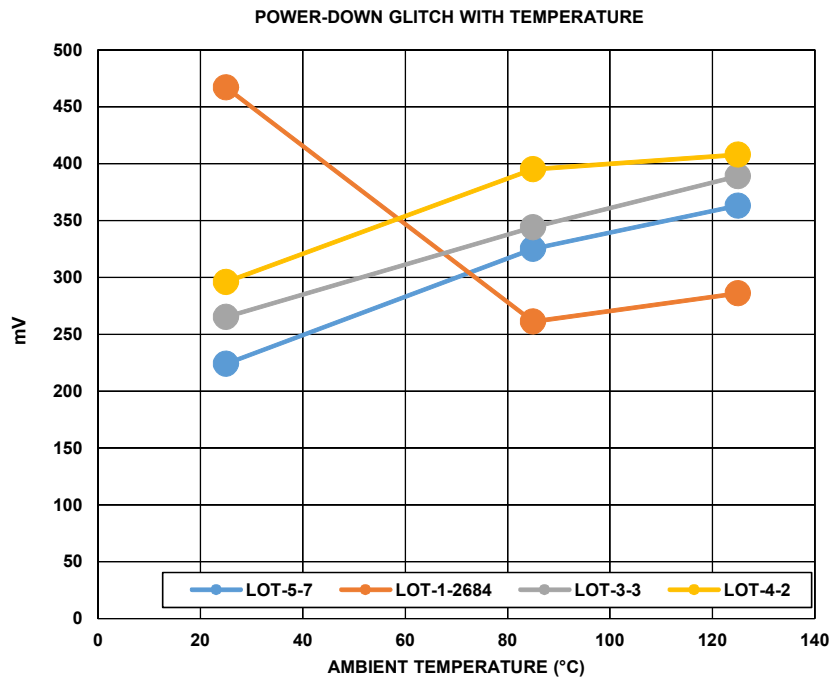

FIGURE 19. POWER-DOWN GLITCH MAGNITUDES AT TEMPERATURES +25°C, +85°C, AND +125°C FOR FOUR SAMPLED UNITS

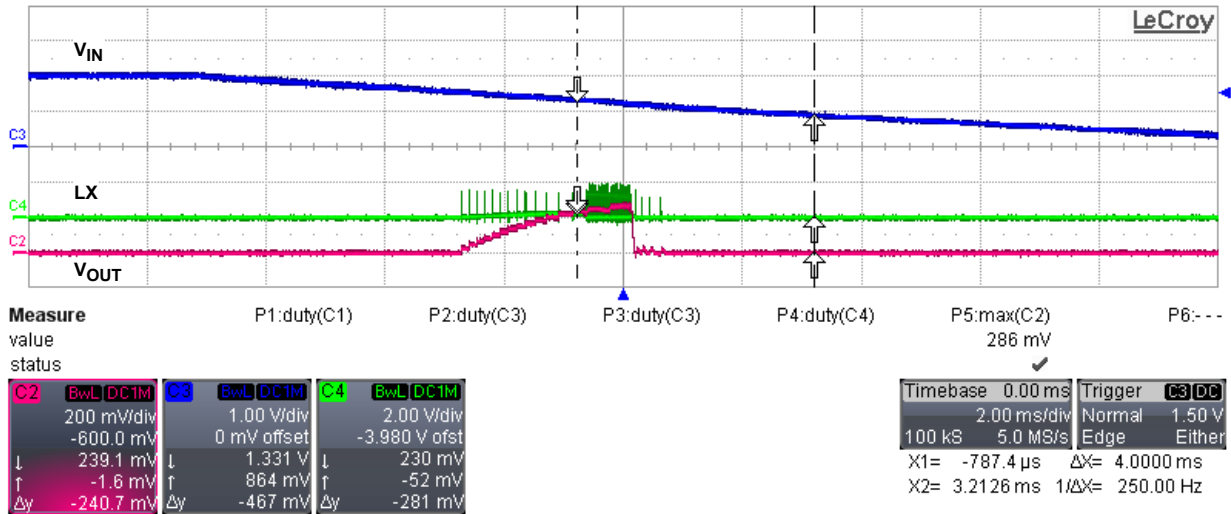

FIGURE 20. LOT-1-2684 POWER-DOWN GLITCH AT +125 °C

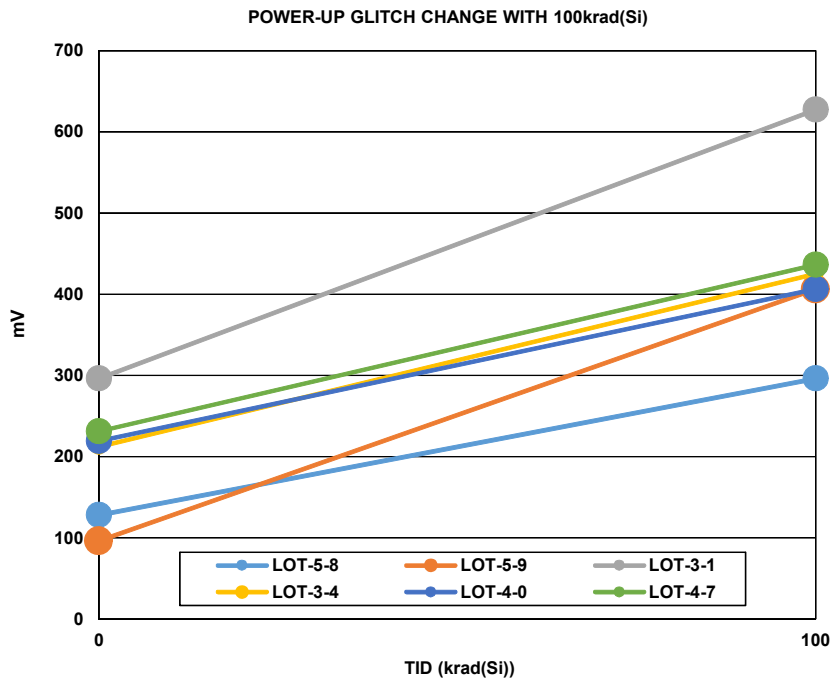

FIGURE 21. PRE- AND POST-RADIATION (100krad(Si)) +25 °C POWER-UP GLITCH MAGNITUDES

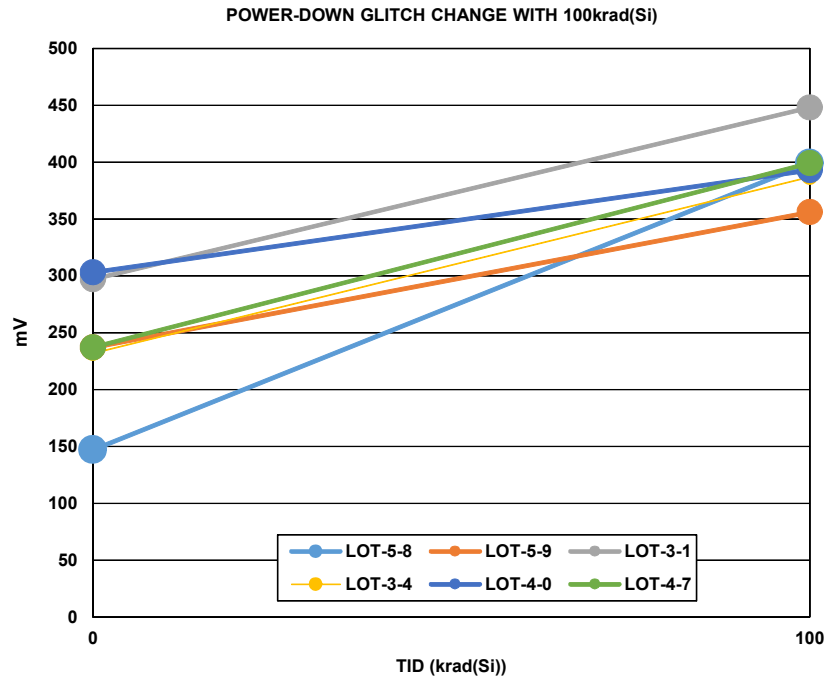

FIGURE 22. PRE- AND POST-RADIATION (100krad(Si)) +25°C POWER-DOWN GLITCH MAGNITUDES

## ISL70001SEH, ISL70001SRH Implemented as Clock Slave or Externally Clocked Device

The ISL70001SEH, ISL70001SRH, when set as a master, the control signal path that controls output activity is such that LX activity starts at ~1.5V prior to it being inhibited by a fuse read at ~1.7V. This design weakness was corrected on the ISL70001A and all subsequent ISL7000x devices.

In the ISL70001SEH, ISL70001SRH when in slave mode, the control signal path from the SYNC input to the output and LX activity is inhibited until the PORSEL selected UVLO threshold is satisfied. This is a different signal path than exists when the ISL70001SEH, ISL70001SRH is in master mode.

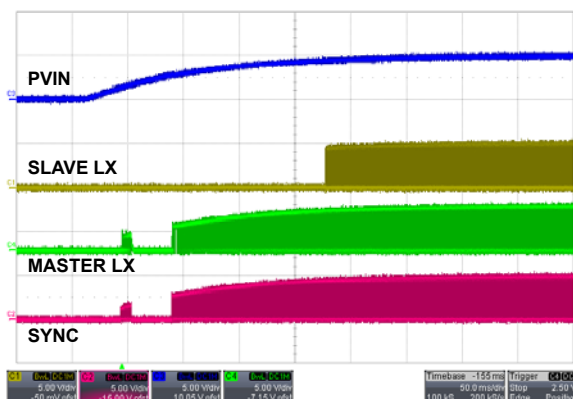

FIGURE 23. SLOW PVIN RISE, RESULTING IN EARLY MASTER LX AND SYNC ACTIVITY WITH NO CLOCKED SLAVE LX ACTIVITY

Figure 23 illustrates the expected behavior when a master and a SYNC clocked slave or externally clocked slave device is powered up slowly. The clocked slave device has its PORSEL = high and the master PORSEL = low. The slow rising PVIN (BLUE) results in the master LX activity (GREEN) accompanied by SYNC (RED) activity, however, no slave LX (YELLOW) activity until the clocked slave UVLO is satisfied.

## Summary

The conditions where ISL70001SEH, ISL70001SRH do not exhibit LX activity below UVLO.

There are several ways to avoid the possibility of ISL70001SEH, ISL70001SRH LX pin pulsing. Any 1 of these 3 conditions will inhibit the LX pin pulsing below UVLO.

1. External Clock
  - a. If the M/S pin is tied low and an external clock is applied to SYNC, the LX pulsing will not occur until UVLO is satisfied.
2. Enable
  - a. If the EN pin is held at <0.5 V until  $V_{IN} > 1.6V$ , the LX pin pulsing will not occur.
  - b. Using a suitable external resistor divider between  $V_{IN}$  and EN will prevent LX pin pulsing.
3. PVIN Ramp
  - a. A 10V/ms minimum PVIN ramp will prevent the LX pin pulsing.

## Notice

1. Descriptions of circuits, software and other related information in this document are provided only to illustrate the operation of semiconductor products and application examples. You are fully responsible for the incorporation or any other use of the circuits, software, and information in the design of your product or system. Renesas Electronics disclaims any and all liability for any losses and damages incurred by you or third parties arising from the use of these circuits, software, or information.
2. Renesas Electronics hereby expressly disclaims any warranties against and liability for infringement or any other claims involving patents, copyrights, or other intellectual property rights of third parties, by or arising from the use of Renesas Electronics products or technical information described in this document, including but not limited to, the product data, drawings, charts, programs, algorithms, and application examples.
3. No license, express, implied or otherwise, is granted hereby under any patents, copyrights or other intellectual property rights of Renesas Electronics or others.
4. You shall not alter, modify, copy, or reverse engineer any Renesas Electronics product, whether in whole or in part. Renesas Electronics disclaims any and all liability for any losses or damages incurred by you or third parties arising from such alteration, modification, copying or reverse engineering.
5. Renesas Electronics products are classified according to the following two quality grades: "Standard" and "High Quality". The intended applications for each Renesas Electronics product depends on the product's quality grade, as indicated below.  
"Standard": Computers; office equipment; communications equipment; test and measurement equipment; audio and visual equipment; home electronic appliances; machine tools; personal electronic equipment; industrial robots; etc.  
"High Quality": Transportation equipment (automobiles, trains, ships, etc.); traffic control (traffic lights); large-scale communication equipment; key financial terminal systems; safety control equipment; etc.  
Unless expressly designated as a high reliability product or a product for harsh environments in a Renesas Electronics data sheet or other Renesas Electronics document, Renesas Electronics products are not intended or authorized for use in products or systems that may pose a direct threat to human life or bodily injury (artificial life support devices or systems; surgical implantations; etc.), or may cause serious property damage (space system; undersea repeaters; nuclear power control systems; aircraft control systems; key plant systems; military equipment; etc.). Renesas Electronics disclaims any and all liability for any damages or losses incurred by you or any third parties arising from the use of any Renesas Electronics product that is inconsistent with any Renesas Electronics data sheet, user's manual or other Renesas Electronics document.
6. When using Renesas Electronics products, refer to the latest product information (data sheets, user's manuals, application notes, "General Notes for Handling and Using Semiconductor Devices" in the reliability handbook, etc.), and ensure that usage conditions are within the ranges specified by Renesas Electronics with respect to maximum ratings, operating power supply voltage range, heat dissipation characteristics, installation, etc. Renesas Electronics disclaims any and all liability for any malfunctions, failure or accident arising out of the use of Renesas Electronics products outside of such specified ranges.
7. Although Renesas Electronics endeavors to improve the quality and reliability of Renesas Electronics products, semiconductor products have specific characteristics, such as the occurrence of failure at a certain rate and malfunctions under certain use conditions. Unless designated as a high reliability product or a product for harsh environments in a Renesas Electronics data sheet or other Renesas Electronics document, Renesas Electronics products are not subject to radiation resistance design. You are responsible for implementing safety measures to guard against the possibility of bodily injury, injury or damage caused by fire, and/or danger to the public in the event of a failure or malfunction of Renesas Electronics products, such as safety design for hardware and software, including but not limited to redundancy, fire control and malfunction prevention, appropriate treatment for aging degradation or any other appropriate measures. Because the evaluation of microcomputer software alone is very difficult and impractical, you are responsible for evaluating the safety of the final products or systems manufactured by you.
8. Please contact a Renesas Electronics sales office for details as to environmental matters such as the environmental compatibility of each Renesas Electronics product. You are responsible for carefully and sufficiently investigating applicable laws and regulations that regulate the inclusion or use of controlled substances, including without limitation, the EU RoHS Directive, and using Renesas Electronics products in compliance with all these applicable laws and regulations. Renesas Electronics disclaims any and all liability for damages or losses occurring as a result of your noncompliance with applicable laws and regulations.
9. Renesas Electronics products and technologies shall not be used for or incorporated into any products or systems whose manufacture, use, or sale is prohibited under any applicable domestic or foreign laws or regulations. You shall comply with any applicable export control laws and regulations promulgated and administered by the governments of any countries asserting jurisdiction over the parties or transactions.
10. It is the responsibility of the buyer or distributor of Renesas Electronics products, or any other party who distributes, disposes of, or otherwise sells or transfers the product to a third party, to notify such third party in advance of the contents and conditions set forth in this document.
11. This document shall not be reprinted, reproduced or duplicated in any form, in whole or in part, without prior written consent of Renesas Electronics.
12. Please contact a Renesas Electronics sales office if you have any questions regarding the information contained in this document or Renesas Electronics products.  
(Note 1) "Renesas Electronics" as used in this document means Renesas Electronics Corporation and also includes its directly or indirectly controlled subsidiaries.  
(Note 2) "Renesas Electronics product(s)" means any product developed or manufactured by or for Renesas Electronics.

(Rev.4.0-1 November 2017)



### SALES OFFICES

Renesas Electronics Corporation

<http://www.renesas.com>

Refer to "<http://www.renesas.com/>" for the latest and detailed information.

**Renesas Electronics America Inc.**  
1001 Murphy Ranch Road, Milpitas, CA 95035, U.S.A.  
Tel: +1-408-432-8888, Fax: +1-408-434-5351

**Renesas Electronics Canada Limited**  
9251 Yonge Street, Suite 8309 Richmond Hill, Ontario Canada L4C 9T3  
Tel: +1-905-237-2004

**Renesas Electronics Europe Limited**  
Dukes Meadow, Millboard Road, Bourne End, Buckinghamshire, SL8 5FH, U.K.  
Tel: +44-1628-651-700, Fax: +44-1628-651-804

**Renesas Electronics Europe GmbH**  
Arcadiastrasse 10, 40472 Düsseldorf, Germany  
Tel: +49-211-6503-0, Fax: +49-211-6503-1327

**Renesas Electronics (China) Co., Ltd.**  
Room 1709 Quantum Plaza, No.27 ZhichunLu, Haidian District, Beijing, 100191 P. R. China  
Tel: +86-10-8235-1155, Fax: +86-10-8235-7679

**Renesas Electronics (Shanghai) Co., Ltd.**  
Unit 301, Tower A, Central Towers, 555 Langao Road, Putuo District, Shanghai, 200333 P. R. China  
Tel: +86-21-2226-0888, Fax: +86-21-2226-0999

**Renesas Electronics Hong Kong Limited**  
Unit 1601-1611, 16/F., Tower 2, Grand Century Place, 193 Prince Edward Road West, Mongkok, Kowloon, Hong Kong  
Tel: +852-2265-6688, Fax: +852-2886-9022

**Renesas Electronics Taiwan Co., Ltd.**  
13F, No. 363, Fu Shing North Road, Taipei 10543, Taiwan  
Tel: +886-2-8175-9600, Fax: +886-2-8175-9670

**Renesas Electronics Singapore Pte. Ltd.**  
80 Bendemeer Road, Unit #06-02 Hyflux Innovation Centre, Singapore 339949  
Tel: +65-6213-0200, Fax: +65-6213-0300

**Renesas Electronics Malaysia Sdn.Bhd.**  
Unit 1207, Block B, Menara Amcorp, Amcorp Trade Centre, No. 18, Jln Persiaran Barat, 46050 Petaling Jaya, Selangor Darul Ehsan, Malaysia  
Tel: +60-3-7955-9390, Fax: +60-3-7955-9510

**Renesas Electronics India Pvt. Ltd.**  
No.777C, 100 Feet Road, HAL 2nd Stage, Indiranagar, Bangalore 560 038, India  
Tel: +91-80-67208700, Fax: +91-80-67208777

**Renesas Electronics Korea Co., Ltd.**  
17F, KAMCO Yangjae Tower, 262, Gangnam-daero, Gangnam-gu, Seoul, 06265 Korea  
Tel: +82-2-558-3737, Fax: +82-2-558-5338